

2017-2018 PRODUCT CATALOG

INDUSTRIAL PLUGS & RECEPTACLES

SWITCH-RATED PLUGS & RECEPTACLES • HAZARDOUS LOCATION PLUGS & RECEPTACLES
MULTIPIN CONNECTORS • HIGH AMPERAGE CONNECTORS • CUSTOM POWER DISTRIBUTION PANELS

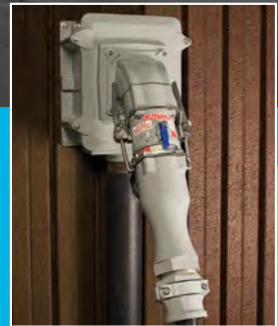

2017-2018 PRODUCT CATALOG



This document is not contractual and we cannot be held responsible for any inadvertent error that may appear in this catalog. We also reserve our right to alter specifications without any prior notice in the continuance of improving our products. For an updated digital copy of this catalog visit meltric.com.

Introduction

MELTRIC Overview	pg 3
Product Features & Benefits	pg 5
Product Summary & Selection Guide	pg 9
Part Number & Ordering Guide	pg 15
Switch-Rated Plugs & Receptacles	
The Main Differences	pg 17
Selection Guide	pg 21
DSN Type 4X rated, metal or poly casings. From 20 – 150A (1/2 – 75 hp)	pg 23
DS Type 3R rated, metal or poly casings. From 20 – 200A (3/4 – 30 hp)	pg 37
DB IP67 rated, metal casings. From 30 – 100A (2 – 60 hp)	pg 55

Multipin Plugs & Receptacles

Multipin 4 – 37 pin connectors in poly and metal. From 2 – 150A	pg 69
--	-------

Standard Duty Plugs & Receptacles

DR Type 3R rated, poly or metal casings. From 30 – 400A	pg 93
PN IP66/IP67 rated or IP54 rated, poly or metal. 20A	pg 111
High Temp For environments up to 465°F (240°C).	pg 119

Direct Current Plugs & Receptacles

DSDC DC current rated, poly or metal casings. Up to 750 VDC	pg 123
--	--------

High Ampacity Plugs & Receptacles

PF/PFQ IP66/IP67 rated, metal construction. From 300 – 600A	pg 127
DR400 Type 3R rated, metal casings. 400A	pg 135
SP Single pole, connectors up to 600A	pg 139
CS1000 Single pole, connectors up to 400A	pg 143

Power Distribution

Custom Power Distribution Solutions Built specifically to meet customer needs	pg 147
Integral Circuit Protection Wall Boxes Premounted receptacles wired to circuit protection 20-60A	pg 155
Safety Switch/Receptacle Combinations Switch-rated receptacles mounted to single throw, fusible safety switch	pg 161

Specialty Products

WS – Welding Connectors Single pole connectors (max 50 VAC)	pg 165
Adapter Plates For converting existing receptacles to MELTRIC	pg 166
Cord Grips	pg 169
Voltage/Phase Rotation Meter Assemblies	pg 171

Hazardous Location Plugs & Receptacles

Hazardous Duty Selection Guide	pg 173
DXN Hazardous rated, poly casings. From 20 – 60A (1/4 – 20 hp)	pg 175
DXA Hazardous rated, metallic casings. From 20 – 100A	pg 187
DS60/DSN150 Hazardous rated, metallic casings. 60 & 150A (2 hp, 75 hp)	pg 189
DX Hazardous rated, metallic casings. From 20 – 100A	pg 195
Multipin Hazardous rated, 12 to 37 pins, 10A	pg 207
SPeX Hazardous rated, up to 680A, 1000VAC	pg 209

MELTRIC Corporation

The best in industrial wiring devices

Safety
Reliability
Service
Value

At MELTRIC Corporation, our only business is electrical plugs and receptacles. We are focused on providing our customers with the best overall value by offering the safest, highest quality and most reliable plugs and receptacles, and by backing them with outstanding service and support.



Product Technology & Safety

The technology behind MELTRIC's products was developed specifically to address the shortcomings and safety hazards common with pin & sleeve type plugs and receptacles. In 1952, following the observation of an accident with a pin and sleeve device, Gilles Marechal devised the concept of combining the advantages of silver-nickel butt contacts and the load making and breaking capabilities of a switch with the convenience of a plug and receptacle. Shortly thereafter, the first of these products was born. MELTRIC licensed this technology in the early 1980's and has been supplying its products to North American customers ever since.

Value

With their unique features and capabilities, MELTRIC products provide users with a safer and more reliable product than competitive pin and sleeve devices. MELTRIC's butt-style contacts provide longer operating lives, optional integral pilot contacts reduce the need for additional connectors and our switch-rated plugs and receptacles can eliminate the need for auxiliary interlocks and disconnect switches, helping users reduce equipment costs. These advantages, together with competitive pricing, short lead times, and 5-year warranty on electrical contacts, make MELTRIC's products the best overall value in the plug & receptacle/connector market.



Service & Support

MELTRIC backs its superior products with outstanding service and support. A network of over 150 sales associates and over 2000 distributor locations throughout the US, Canada and Mexico make access to our product easy.

MELTRIC's Customer Service group is trained to answer most questions on the spot and is located at our manufacturing facility in order to help streamline the order fulfillment process. Our engineering team stands ready to provide both application support and custom designed products incorporating MELTRIC and third party components into power distribution products tailored to meet your needs. Friendly and personal assistance is only a toll free call away at (800) 433-7642.

Many of MELTRIC's products are designed in a modular fashion, which permits cost effective stocking of components and quick final assembly of the product. Together with efficient order handling by Customer Service, this helps MELTRIC to provide the shortest lead times in the industry.

Quality

Quality is not just an inspection function at MELTRIC. Quality starts with intelligent designs, robust materials, clear procedures, process measurement and controls and effective communications. It is completed by the care, commitment and involvement of each of our employees.

MELTRIC is dedicated to the continuous improvement of all its critical production and support processes and is ISO 9001:2008 certified. MELTRIC designs and manufactures its products to exceed the requirements of applicable UL, CSA and IEC standards.

Worldwide Availability

Marechal Technology products are manufactured in North America, Europe, South Africa and Australia. MELTRIC supplies product directly from its factory in Franklin, Wisconsin to customers in the United States, Canada and Mexico. For customers outside of North America, product is provided through other Marechal Electric Group companies and sales agents.

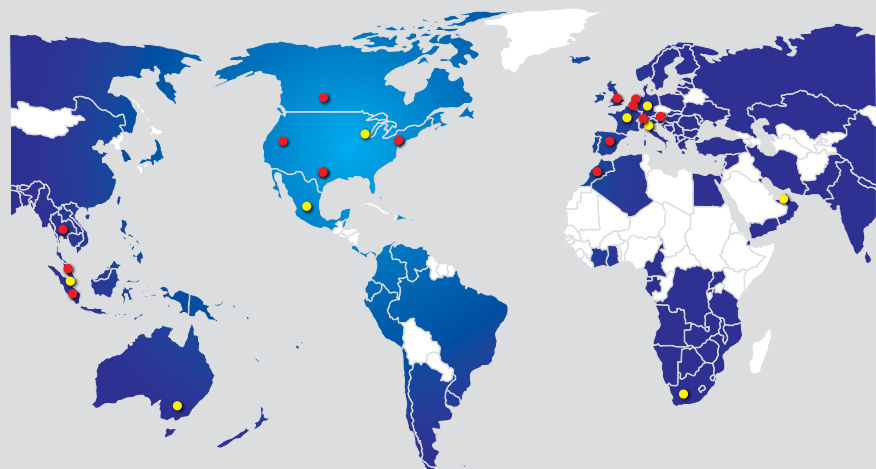

- SALES OFFICES & MANUFACTURING PLANTS
- COMPANY SALES PRESENCE
- SALES AGENTS & DISTRIBUTORS

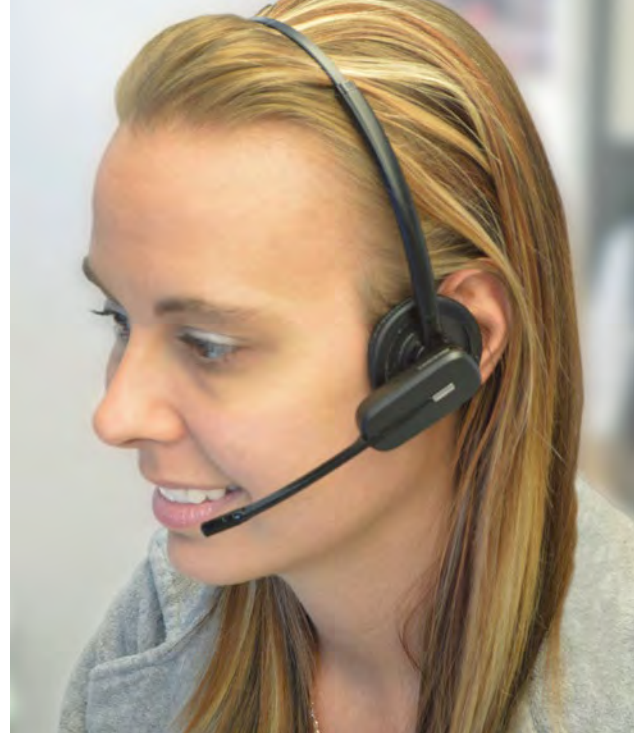

MELTRIC Product Features...

Spring-Loaded Butt Contacts

MELTRIC products feature spring-loaded butt contacts similar to those used in contactors and switchgear. These contacts have numerous advantages, which help improve electrical performance and user safety relative to pin and sleeve contacts or the arcuate contacts used in twist-type devices.

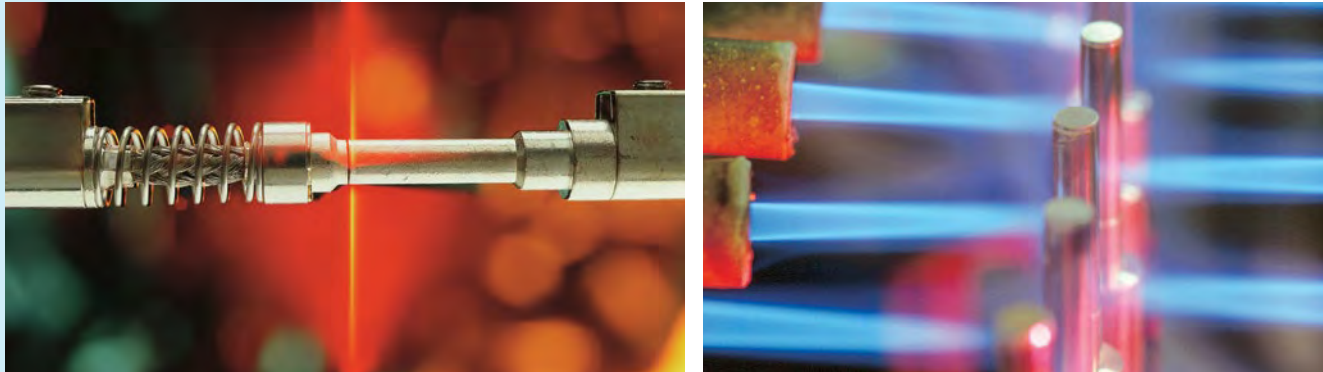

Butt-style contacts ensure a very positive and consistent connection. The spring-loading of these contacts, which is accomplished with coil springs, provides a desirably high contact force that remains constant over thousands of operations. In addition, it automatically compensates for any wear and/or deviations in contact length resulting from manufacturing tolerances.

This is a critical point, as contact force is a key determinant of the quality of a contact. As the accompanying chart demonstrates, contact resistance increases as contact force is reduced. Higher contact resistance generates more heat and oxidation, both of which contribute to the deterioration of the contact. This is a problem with pin and sleeve and arcuate type contacts because their contact force varies with manufacturing tolerances and is reduced due to wear that occurs with normal use.

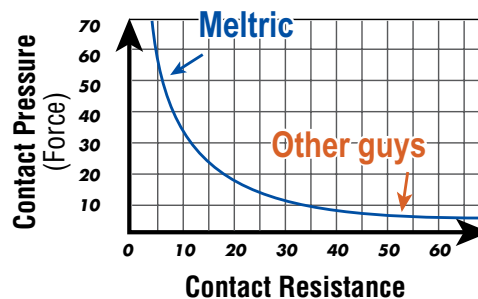

MELTRIC contacts close with a self-cleaning wiping action. When the contacts initially mate, they are slightly offset. In completing the connection, the plug contacts are rotated across the receptacle contacts, helping to remove deposits from the contact surfaces.

In conjunction with the spring-loaded casings used on many MELTRIC products, the spring-loaded contacts ensure a quick breaking of the connection that is independent of the motion of the user. By contrast, the disconnection speed of pin and sleeve and twist-type devices is dependent upon the motion of the user.

...and Benefits

Silver-Nickel Contact Material

MELTRIC uses solid silver-nickel (85%/15%) contacts. The silver-nickel material has significant advantages over the brass contacts commonly used on competitive devices.

Silver has very low initial contact resistance and is not negatively affected by oxidation. This helps to give it excellent electrical properties that are maintained even at high temperatures and after tarnishing. Nickel is a much harder material and contributes excellent mechanical properties. The combination of silver and nickel results in a contact material that has both superior electrical capabilities and excellent resistance to wear. Silver-nickel only welds at extremely high pressure and temperature, and thus, also withstands arcs very well. These features make silver-nickel a commonly used contact material by switchgear manufacturers.



MATERIAL	CONTACT RESISTANCE	
	NEW	OXIDIZED
SILVER	6 $\mu\Omega$	25 $\mu\Omega$
SILVER-NICKEL	23 $\mu\Omega$	60 $\mu\Omega$
COPPER	29 $\mu\Omega$	400 $\mu\Omega$
BRASS	370 $\mu\Omega$	1400 $\mu\Omega$

By contrast, the brass material used in most competitive plug and receptacles has much higher initial contact resistance and is negatively affected by oxidation. In an oxidized state, the contact resistance of brass is more than 20 times higher than that of silver-nickel. In addition, brass is a soft material that wears rapidly. In use, brass pin and sleeve and arcuate contacts suffer from the combined effects of the limitations of the material and the design. As oxidation and wear induced reductions in contact force occur, contact resistance increases. This increases operating temperature, which causes further oxidation and wear, perpetuating a vicious cycle of degradation. Brass is not arc resistant and is not suitable for making and breaking under load.

Dead Front Construction

Most MELTRIC products feature dead front construction, which greatly enhances safety by eliminating any unintended access to live parts. On most MELTRIC products, the dead front is accomplished with a safety shutter that can be opened only by an appropriate mating plug. The live receptacle contacts can only be accessed by the plug, after its insertion into the receptacle. The design of the product also ensures that the plug contacts are dead before the user can remove the plug from the receptacle.

By contrast, pin and sleeve and twist-type devices do not have a safety shutter. Access to live receptacle contacts is possible, and on some devices the plug contacts may be live and accessible when the plug is being removed.



MELTRIC Product Features...



Push-Button Circuit Disconnection

To disconnect most MELTRIC products, the user simply needs to depress the pawl. This causes the circuit to be disconnected and the plug to be ejected to its rest (off) position in the receptacle. If desired, the user can then remove the plug from the receptacle by rotating it slightly and then withdrawing it. This mode of operation ensures that it is only possible to remove the plug after its contacts have been deenergized.

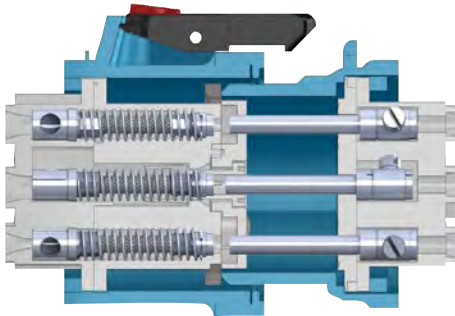

Enclosed Arc Chambers

The contacts on most MELTRIC products make and break within enclosed arc chambers. This ensures that the arcing which normally occurs during the making and breaking of the contacts is contained inside the device. This greatly enhances safety and avoids potential injury to users and/or harm to the outside environment.



Auxiliary/Pilot
Contacts

Optional Auxiliary/Pilot Contacts

Many MELTRIC products are available with optional auxiliary/pilot contacts. These integral pilot contacts allow users the convenience and flexibility of controlling auxiliary equipment, monitoring parameters (such as motor temperature), and/or communicating alarms through the same plug and receptacle used to supply power to the equipment. Because the pilot contacts are integral, they also facilitate the rapid change-out or reconfiguration of equipment by eliminating the need for hard wiring or multiple plug connections.



Automatic Watertightness

On most pin and sleeve devices, an additional plastic ring must be tightened in order to ensure the achievement of rated watertightness. Users frequently fail to do this, resulting in leakage. MELTRIC solves this problem with its DS and DSN Switch-Rated plugs and receptacles, which achieve their rated watertightness of up to Type 4X simply by mating the plug with the receptacle. After the removal of the plug, rated watertightness is maintained for the receptacle by simply closing the lid.

...and Benefits

Spring-Assisted Terminals

The loosening of terminal screws is a common cause for failure on standard plugs and receptacles. MELTRIC provides a more permanent and secure connection with its unique and patented spring-assisted terminal design.

As the terminal screw is tightened against the conductor, the associated pressure expands the split terminal body, causing a spring ring surrounding the terminal to deform into an elliptical shape. The natural tendency for the spring ring to return to its original size and shape ensures that a constant pressure is maintained on the conductor. This allows the terminal to effectively compensate for strand settlement and conductor yield, due to cold flow of the material, and provides superior resistance to vibration, shock and thermal cycling.

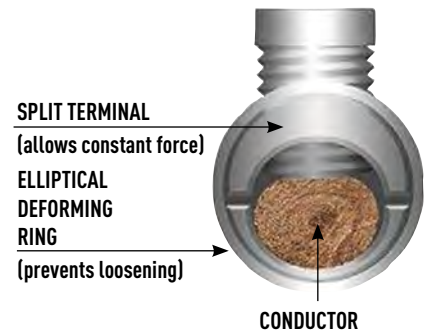

Lockout-Tagout Capability

Most MELTRIC plugs and receptacles facilitate compliance with OSHA lockout-tagout requirements. Only a lock or lockout hasp and tag are needed to ensure that the plug is properly locked out and tagged out. Additional mechanisms are not required because the lockout provision is integral to the device – it is always available when you need it. On most models the lockout provision is a simple 5/16" hole in the plug shroud that facilitates the insertion of a typical padlock or lockout hasp which prevents the plug from being inserted into a receptacle.

An optional provision for locking out MELTRIC receptacles is also available. In most cases this is accomplished via a specially machined hole in the receptacle casing which allows insertion of a padlock to secure the receptacle lid in a closed position. This same optional provision can be used to prevent removal of the plug if desired.

By comparison, in order to lockout most competitive pin and sleeve type plugs, an additional third-party 'lockout shield' or 'plug cap' is required. These devices can be expensive and are often times lost, broken, or not available when you need them.

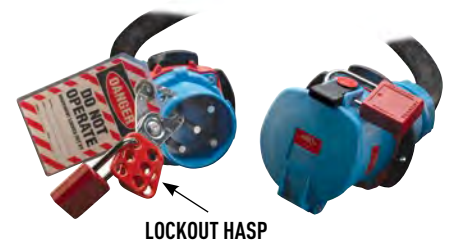





Modular Construction

Due to the robust construction of MELTRIC devices, the need to replace worn parts is rare. However, should they be required, parts are readily available and reasonably priced. The modular construction of most MELTRIC devices enables easy replacement of parts in the field.



MELTRIC Product Summary and Selection Guide



	Model	Amp Rating	Maximum Voltage Rating		Environmental Ratings		Available Casing Materials			Maximum Number of Contacts	
			VAC	VDC	Type	IP	Poly	Metal	SS	Main	Aux.
Switch-Rated	 DSN20	20	600	-	4X	66/67	Poly	-	-	3P+N+G	-
	DSN30	30	600	-	4X	66/67	Poly	-	-	3P+N+G	2
	DSN60	60	600	-	4X	66/67	Poly	-	-	3P+N+G	4
	DSN150	150	600	-	4X	66/67	Poly	Metal	-	3P+N+G	6
	DS20	20	600	-	3R	54/55	Poly	-	SS	3P+N+G	2
	DS30	30	600	-	3R	54/55	Poly	-	SS	3P+N+G	4
	 DS60	60	600	-	3R	54/55	Poly	Metal	-	3P+N+G	3
	DS100C	100	600	-	3R	54/55	Poly	Metal	-	3P+N+G	3
	DS100	100	600	-	3R	54/55	Poly	Metal	-	3P+N+G	6
	DS200	200	480	-	3R	54/55	-	Metal	-	3P+N+G	5
	 DB30	30	600	-	-	67	-	Metal	-	3P+N+G	2
	DB60	60	600	-	-	67	-	Metal	-	3P+N+G	2
	DB100	100	600	-	-	67	-	Metal	-	3P+N+G	4
Multipin	 PN7c	15	600	130	-	66/67*	Poly	Metal	SS	6P+G	-
	PN7c	20	600	130	-	66/67*	Poly	Metal	SS	6P+G	-
	PN12c	5	600	-	-	66/67*	Poly	Metal	SS	11P+G	-
	PN12c	7.5	600	-	-	66/67*	Poly	Metal	SS	11P+G	-
	DSN24c	2	480	130	-	66/67	Poly	-	-	24	-
	DSN24c	7.5	480	130	-	66/67	Poly	-	-	24	-
	DS24c	2	250	130	-	-	-	-	SS	24	-
	DS24c	7.5	250	130	-	-	-	-	SS	24	-
	DSN37c	2	480	130	-	66/67	Poly	-	-	37	-
	DSN37c	7.5	480	130	-	66/67	Poly	-	-	37	-
	DS37c	2	480	130	-	-	-	-	SS	37	-
	DS37c	7.5	480	130	-	-	-	-	SS	37	-

* The indicated ratings do not apply to devices with SS casings.

Model	Current Interruption Rating*	Horsepower Ratings (see catalog section for other voltages)			Main Contacts Wire Size Capacity		Terminal Type
		240V - 3Ø	480V - 3Ø	600V - 3Ø	Min	Max	
DSN20	Switch-Rated	2 hp	5 hp	5 hp	14 AWG	12 AWG	Screw
DSN30	Switch-Rated	5 hp	10 hp	15 hp	14 AWG	8 AWG	Screw
DSN60	Switch-Rated	7 ½ hp	20 hp	20 hp	12 AWG	4 AWG	Screw
DSN150	Switch-Rated	30 hp	75 hp	75 hp	4 AWG	2/0 AWG	Screw
DS20	Switch-Rated	5 hp	7.5 hp	10 hp	14 AWG	8 AWG	Screw
DS30	Switch-Rated	5 hp	15 hp	15 hp	14 AWG	4 AWG	Screw
DS60	Switch-Rated	10 hp	20 hp	25 hp	10 AWG	2 AWG	Screw
DS100C	Switch-Rated	10 hp	25 hp	25 hp	10 AWG	2 AWG	Screw
DS100	Switch-Rated	10 hp	30 hp	-	4 AWG	2/0 AWG	Screw
DS200	Switch-Rated	-	-	-	4 AWG	4/0 AWG	Screw
DB30	Switch-Rated	7 ½ hp	20 hp	25 hp	14 AWG	8 AWG	Screw
DB60	Switch-Rated	15 hp	30 hp	30 hp	8 AWG	3 AWG	Screw
DB100	Switch-Rated	30 hp	60 hp	60 hp	1/0 AWG	2/0 AWG	Screw
PN7c	Current Interrupting	-	-	-	18 AWG	10 AWG	Screw
PN7c	Non-Current Interrupting	-	-	-	18 AWG	10 AWG	Screw
PN12c	Current Interrupting	-	-	-	18 AWG	14 AWG	Solder/Crimp
PN12c	Non-Current Interrupting	-	-	-	18 AWG	14 AWG	Solder/Crimp
DSN24c	Current Interrupting	-	-	-	18 AWG	14 AWG	Solder/Crimp
DSN24c	Non-Current Interrupting	-	-	-	18 AWG	14 AWG	Solder/Crimp
DS24c	Current Interrupting	-	-	-	18 AWG	14 AWG	Solder/Crimp
DS24c	Non-Current Interrupting	-	-	-	18 AWG	14 AWG	Solder/Crimp
DSN37c	Current Interrupting	-	-	-	18 AWG	14 AWG	Solder/Crimp
DSN37c	Non-Current Interrupting	-	-	-	18 AWG	14 AWG	Solder/Crimp
DS37c	Current Interrupting	-	-	-	18 AWG	14 AWG	Solder/Crimp
DS37c	Non-Current Interrupting	-	-	-	18 AWG	14 AWG	Solder/Crimp

* 'Switch-Rated' and 'Current Interrupting' ratings apply to alternating current only.

MELTRIC Product Summary & Selection Guide

	Model	Amp Rating	Maximum Voltage Rating		Environmental Ratings		Available Casing Materials			Maximum Number of Contacts	
			VAC	VDC	Type	IP	Poly	Metal	SS	Main	Aux.
Multipin 	DN9c	20	480	130	-	54/55	-	Metal	-	9	-
	DN20c	20	480	130	-	54/55	-	Metal	-	20	-
	DS7c	30	600	130	-	54/55	Poly	Metal	-	7	3
	DR7c	50	600	130	-	54/55	Poly	Metal	-	7	3
Standard 	DR30	30	600	-	3R	54/55	Poly	-	-	3P+N+G	2
	DR50	50	600	-	3R	54/55	Poly	-	-	3P+N+G	4
	DR100	100	600	-	3R	54/55	Poly	Metal	-	3P+N+G	3
	DR150	150	600	-	3R	54/55	Poly	Metal	-	3P+N+G	6
	DR250	250	600	-	3R	54/55	-	Metal	-	3P+N+G	5
	DR400	400	480**	-	3R	54/55	-	Metal	-	3P+N+G	2
	PN	15	600	-	-	55 or 66+67*	Poly	Metal	SS	3P+N+G	-
	PN	20	480	-	-	55 or 66+67*	Poly	Metal	SS	3P+N+G	-
	PNHT	30	480	-	-	44	-	Metal	-	3P+N+G	-
Direct Current 	DSDC1	20	-	250	3R	54/55	Poly	-	-	2P+G	0
	DSDC1	15	-	600	3R	54/55	Poly	-	-	2P+G	0
	DSDC1	10	-	750	3R	54/55	Poly	-	-	2P+G	0
	DSDC3	30	-	250	3R	54/55	Poly	-	-	2P+G	0
	DSDC3	30	-	600	3R	54/55	Poly	-	-	2P+G	0
	DSDC3	20	-	750	3R	54/55	Poly	-	-	2P+G	0
	DSDC6	60	-	250	3R	54/55	Poly	Metal	-	2P+G	0
	DSDC6	50	-	600	3R	54/55	Poly	Metal	-	2P+G	0
	DSDC6	30	-	750	3R	54/55	Poly	Metal	-	2P+G	0
	DSDC9	100	-	250	3R	54/55	Poly	Metal	-	2P+G	0
	DSDC9	60	-	600	3R	54/55	Poly	Metal	-	2P+G	0
	DSDC2	200	-	250	3R	54/55	-	Metal	-	2P+G	0
DSDC2	100	-	600	3R	54/55	-	Metal	-	2P+G	0	

* The indicated ratings do not apply to devices with SS casings.













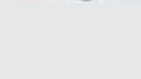







** 600V available at 350 amps.

¹ Up to 250VAC.

Model	Current Interruption Rating*	Horsepower Ratings (see catalog section for other voltages)			Main Contacts Wire Size Capacity		Terminal Type
		240V - 3Ø	480V - 3Ø	600V - 3Ø	Min	Max	
DN9c	Current Interrupting	3 hp	5 hp	-	16 AWG	10 AWG	Screw
DN20c	Current Interrupting	1 hp	3 hp	-	16 AWG	10 AWG	Screw
DS7c	Current Interrupting	-	-	-	14 AWG	8 AWG	Screw
DR7c	Non-Current Interrupting	-	-	-	14 AWG	8 AWG	Screw
DR30	Non-Current Interrupting	-	-	-	14 AWG	8 AWG	Screw
DR50	Current Interrupting	-	-	-	14 AWG	4 AWG	Screw
DR100	Current Interrupting	-	-	-	10 AWG	2 AWG	Screw
DR150	Current Interrupting	-	-	-	4 AWG	2/0 AWG	Screw
DR250	Non-Current Interrupting	-	-	-	4 AWG	4/0 AWG	Screw
DR400	Non-Current Interrupting	-	-	-	2 AWG	350 MCM	Screw
PN	Current Interrupting	-	-	-	14 AWG	8 AWG	Screw
PN	Current Interrupting	-	-	-	14 AWG	8 AWG	Screw
PNHT	Non-Current Interrupting	-	-	-	14 AWG	8 AWG	Screw
DSDC1	Non-Current Interrupting	-	-	-	14 AWG	8 AWG	Screw
DSDC1	Non-Current Interrupting	-	-	-	14 AWG	8 AWG	Screw
DSDC1	Non-Current Interrupting	-	-	-	14 AWG	8 AWG	Screw
DSDC3	Non-Current Interrupting	-	-	-	14 AWG	6 AWG	Screw
DSDC3	Non-Current Interrupting	-	-	-	14 AWG	6 AWG	Screw
DSDC3	Non-Current Interrupting	-	-	-	14 AWG	6 AWG	Screw
DSDC6	Non-Current Interrupting	-	-	-	10 AWG	2 AWG	Screw
DSDC6	Non-Current Interrupting	-	-	-	10 AWG	2 AWG	Screw
DSDC6	Non-Current Interrupting	-	-	-	10 AWG	2 AWG	Screw
DSDC9	Non-Current Interrupting	-	-	-	8 AWG	2/0 AWG	Screw
DSDC9	Non-Current Interrupting	-	-	-	8 AWG	2/0 AWG	Screw
DSDC2	Non-Current Interrupting	-	-	-	4 AWG	2/0 AWG	Screw
DSDC2	Non-Current Interrupting	-	-	-	4 AWG	2/0 AWG	Screw

* 'Current Interrupting' rating applies to alternating current only.

Meltric Product Summary & Selection Guide

	Model	Amp Rating	Maximum Voltage Rating		Environmental Ratings		Available Casing Materials			Maximum Number of Contacts	
			VAC	VDC	Type	IP	Poly	Metal	SS	Main	Aux.
High Ampacity	 PFQ	300	600	250	-	66/67	-	Metal	-	3P+N+G	8
	 PF300	300	600	250	-	66/67	-	Metal	-	3P+N+G	4
	 PF400	400	600	250	-	66/67	-	Metal	-	3P+N+G	4
	 PF600	600	600	250	-	66/67	-	Metal	-	3P+N+G	4
	 SP	600	600	1500	-	66/67	Poly	-	-	1P	-
	 CS1000	400	1000	1500	-	66/67	Poly	-	-	1P	-
Hazardous Location	 DXN20	20	480	-	-	66/67	Poly	-	-	3P+N+G	-
	 DXN30	30	600	-	-	66/67	Poly	-	-	3P+N+G	2
	 DXN60	60	600	-	-	66/67	Poly	-	-	3P+N+G	2
	 DXA1	20	550	-	-	66/67	-	Metal	-	3P+N+G	-
	 DS60	60	600	-	4X	-	-	Metal	-	3P+N+G	2
	 DSN150	150	600	-	4X	-	-	Metal	-	3P+N+G	6
	 DX20	20	600	-	-	65	-	Metal	-	3P+N+G	-
	 DX30	30	600	-	-	65	-	Metal	-	3P+N+G	-
	 DX60	60	600	-	-	65	-	Metal	-	3P+N+G	-
	 DX100	100	600	-	-	65	-	Metal	-	3P+N+G	-
	 PXN12c	10	220	-	-	65/66	-	Metal	-	12	-
	 DXN25c	10	440	-	-	66/67	-	Metal	-	25	-
	 DXN37c	10	220	-	-	66/67	-	Metal	-	37	-
	 SPeX	680	1000	-	-	65/66	Poly	-	-	1P	-

Model	Current Interruption Rating	Horsepower Ratings (see catalog section for other voltages)			Main Contacts Wire Size Capacity		Terminal Type
		240V - 3Ø	480V - 3Ø	600V - 3Ø	Min	Max	
PFQ	Non-Current Interrupting	-	-	-	2 AWG	600 MCM	Lug
PF300	Non-Current Interrupting	-	-	-	2 AWG	600 MCM	Lug
PF400	Non-Current Interrupting	-	-	-	2 AWG	600 MCM	Lug
PF600	Non-Current Interrupting	-	-	-	2 AWG	600 MCM	Lug
SP	Non-Current Interrupting	-	500 hp	500 hp	2/0 AWG	777 MCM	Lug
CS1000	Non-Current Interrupting	-	-	-	2/0 AWG	444 MCM	Lug
DXN20	Current Interrupting	2 hp	5 hp	5 hp	16 AWG	10 AWG	Screw
DXN30	Current Interrupting	5 hp	10 hp	15 hp	14 AWG	6 AWG	Screw
DXN60	Current Interrupting	5 hp	20 hp	20 hp	10 AWG	4 AWG	Screw
DXA1	Current Interrupting	-	-	-	16 AWG	10 AWG	Screw
DS60	Non-Current Interrupting	10 hp	20 hp	25 hp	10 AWG	2 AWG	Screw
DSN150	Non-Current Interrupting	30 hp	75 hp	75 hp	4 AWG	2/0 AWG	Screw
DX20	Current Interrupting	-	-	-	14 AWG	8 AWG	Screw
DX30	Current Interrupting	-	-	-	14 AWG	8 AWG	Screw
DX60	Current Interrupting	-	-	-	6 AWG	1/0 AWG	Screw
DX100	Current Interrupting	-	-	-	1/0 AWG	2/0 AWG	Screw
PXN12c	Non-Current Interrupting	-	-	-	16 AWG	14 AWG	Solder/Crimp
DXN25c	Non-Current Interrupting	-	-	-	16 AWG	14 AWG	Solder/Crimp
DXN37c	Non-Current Interrupting	-	-	-	16 AWG	14 AWG	Solder/Crimp
SPeX	Non-Current Interrupting	-	-	-	2/0 AWG	750 MCM	Lug

MELTRIC Part Numbering...



First seven (7) digits for a basic inlet or receptacle part number

One (1) to six (6) suffixes for special features

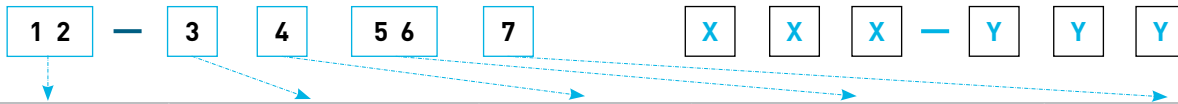

MELTRIC Product Line Type and Casing Material	AMP (A) Rating		Form and Mounting	Voltage Polarization			Phasing
	Position	Voltage		Hz			
PN/PN7c 01 = Blue Poly 09 = Blue Metal	DSN 1 = 20 3 = 30 6 = 60 9 = 150	DXN 1 = 20 3 = 30 6 = 60	Female 4 = Receptacle	01 = $\frac{220 - 250}{380 - 440}$	50	AC 2 = 2P+G AC 3 = 3P+G AC 5 = 1P+N+G AC 6 = 2P+N+G AC 7 = 3P+N+G AC A+ = 2P AC B+ = 3P AC C+ = 3P+N AC D+ = 1P+N AC G+ = 2P+N AC	
PN12c 03 = Blue Poly 07 = Blue Metal			Male 8 = Inlet	02 = 20/24	60		
PXN12c 06 = Black Metal	DS 1 = 20 3 = 30 6 = 60/100C 9 = 100	DXA1 1 = 20	DX, DXN37c, PXN12c, SPeX Only	03 = $\frac{110 - 130}{190 - 230}$	50		
DN 17 = Blue Metal		DX 2 = 20* 3 = 30* 6 = 60* 9 = 100*		04 = $\frac{255 - 277}{440 - 480}$	60		
DXN 22 = Black Poly				06 = 25/28	50		
DXA1 29 = Black Metal	DB 3 = 30* 6 = 60* 9 = 100*			07 = $\frac{110 - 125}{220 - 250}$	60		
DX 26 = Black Metal		PF 3 = 300* 4 = 400* 6 = 600*		08 = 20/24	50		
DS 33 = Blue Poly 35 = Black Poly 36 = Black Metal (HazLoc) 37 = Blue Metal	DR 1 = 30 3 = 50 6 = 100 9 = 150			09 = 480/500	50		
DXN25/37c 36 = Black Metal		PFQ 3 = 300*		10 = 110/130	DC	DC 8++ = 2P+G DC 9 = 2P+G DC Z+ = 2P DC P = 2P+2P+G DC	
DR 31 = Blue Poly 39 = Blue Metal		DN 1 = 20*(DN9) 6 = 20*(DN20)		11 = $\frac{115 - 127}{200 - 220}$	400	* For 50V or less only. ** Includes jumpers.	
SPeX 42 = Black Poly	PN N = 20 (IP66/ IP67) S = 20 (IP54/ IP55) 2 = 20			12 = $\frac{115 - 127}{200 - 220}$	200		
CS1000/SP 45 = Black Poly				13 = 40/48	50		
PFQ 47 = Gray Metal			14 = 347/600	60			
PF 49 = Gray Metal			16 = $\frac{120 - 127}{208 - 220}$	60			
DSN 63 = Blue Poly 65 = Black Poly 66 = Black Metal (HazLoc) 69 = Blue Metal			17* = $\frac{110 - 125}{220 - 250}$	60			
DB 89 = Blue Metal			18* = 347/600	60			
			19 = $\frac{380 - 400}{660 - 690}$	50			
			20 = 220/250	DC			
			22 = 577/1000	50			
			23* = $\frac{120 - 127}{208 - 220}$	60			
			24* = $\frac{255 - 277}{440 - 480}$	60			

- Notes:**
- On metal devices, plugs are not painted, receptacles are painted.
 - This is the Keying Standard for MELTRIC products. Suffixes are available to accommodate non-interchangeable devices of the same size at the same voltage. Please ask for more details.

...and Ordering Guide

A MODULAR SYSTEM

MELTRIC products are ordered and assembled in a modular fashion. Customers should select the desired male inlet and female receptacle part numbers. Then matching accessories such as handles, angles, and junction boxes should be identified and added to the order to create plugs, connectors, or other configurations. This modular system allows MELTRIC to build and ship product to customer specifications in a very short time - 90% of orders ship by the next business day.

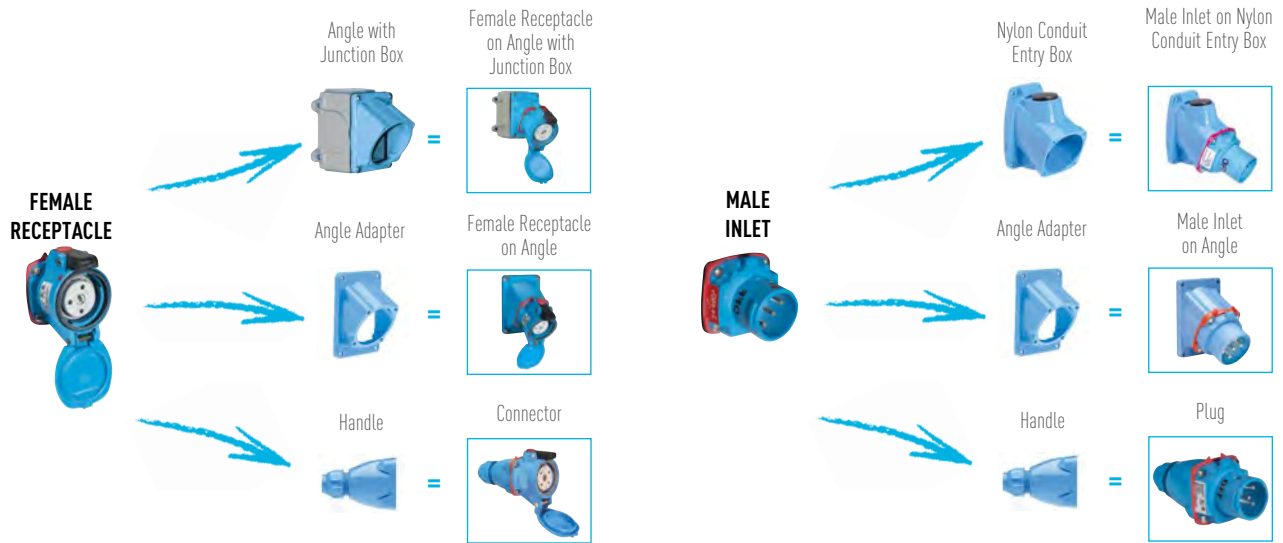



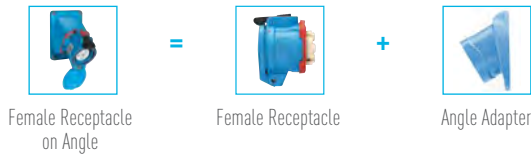

EXAMPLE

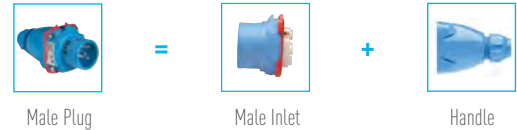

EXAMPLE



TYPICAL ORDER

-  63-34047 Female Receptacle
-  61-3A027 Angle Adapter for Female
-  63-38047 Male Inlet
-  61-3A013 Handle for Male

Switch-Rated Plugs & Receptacles

The Main Differences



DECONTACTOR™ Technology

Like most MELTRIC products, Switch-Rated plugs and receptacles feature (see pgs 6-8)

- ▶ Spring-loaded butt contacts
- ▶ Silver-nickel contact materials
- ▶ Dead front design
- ▶ Enclosed arc chambers
- ▶ Spring-assisted terminals
- ▶ Auxiliary contacts

MELTRIC Switch-Rated plugs and receptacles have additional features, including:

- ▶ UL & CSA switch-ratings
- ▶ Horsepower ratings
- ▶ Short circuit ratings up to 100 kA in fuse protected circuits

Pressing the pawl/button on the receptacle will safely switch off power to the load.. The plug can then be withdrawn in complete safety. (Cutaway model shown for illustration purposes)

Switch and Hp Ratings

MELTRIC Switch-Rated products are a combination plug, receptacle and disconnect switch in the same device. Their integral switch technology ensures the safe breaking of resistive and inductive loads (up to 75 hp or 200A) before an operator can physically remove the plug from the receptacle.

They are UL and CSA approved for both “branch circuit” and “motor circuit” disconnect switching, making them ideal for connecting motors, welding machines and virtually any other electrical equipment.



To match the functionality of a Switch-Rated device, it would take a pin and sleeve plug plus a non-fused safety switch.

Short Circuit Ratings

MELTRIC Switch-Rated plugs and receptacles help ensure worker safety even in fault conditions. They are rated to close into and withstand short circuit currents of 65 kA to 100 kA. The protection far surpasses that offered by other plugs and receptacles, and even surpasses the short circuit protection offered by most manual motor controllers and mechanical interlocks.



Don't let this happen to you!
Pin and sleeve devices are not safe to make and break under load - MELTRIC Switch-Rated devices are.

UL & CSA Standards

Test requirements and ratings comparison table

To achieve their UL 2682 switch ratings, MELTRIC Switch-Rated plugs and receptacles have passed tests that far exceed those of ordinary plugs and receptacles. These tests include horsepower/locked rotor overload tests from the UL 508 Standard for Industrial Control Equipment and electrical endurance and short-circuit make-and-withstand testing from the UL 98 standard for Enclosed and Dead Front Switches.

To illustrate how the electrical and mechanical endurance of MELTRIC Switch-Rated plugs and receptacles far exceeds standard plugs, the following chart compares the test requirements for achieving a Switch-Rated plug & receptacle listing with those required for a standard pin and sleeve plug & receptacle listing.

Test	UL 1682 & CSA 22.2 No. 182.1		UL Subject 2682 (used for both UL & CSA listings)
	Plugs, Receptacles & Cable Connectors of the Pin & Sleeve Type		Switch-Rated Plugs & Receptacles
	Non-Current Interrupting Break (minimum requirements)	Current Interrupting (minimum requirements)	Motor Circuit/Branch Circuit Disconnect Switching (Tests passed by MELTRIC devices)
Temperature Rise	< 30°C	< 30°C	< 30°C
Voltage Withstand	3,000VAC for 1 Minute	3,000VAC for 1 Minute	3,000VAC for 1 Minute
Overload General Use Devices	3 Operations @ 150% of Rated Current (p.f. = .75 - .80)	50 Operations @ 150% of Rated Current (p.f. = .75 - .80)	50 Operations @ 150% of Rated Current (p.f. = .75 - .80)
Mechanical Endurance (Plus Req'd Electrical Opns)	15-20A = 5000 Opns 21-63A = 2000 Opns 64-250A = 250 Opns	15-20A = 0 Opns 21-63A = 1000 Opns 64-250A = 500 Opns	4,000 Cycles
Electrical Endurance (With Load)	-	15-20A = 5000 Opns 21-63A = 1000 Opns ¹ 64-250A = 250 Opns ¹ @ Rated Current & Voltage (p.f. = .75 - .80)	6000 Cycles @ Rated Current & Voltage (p.f. = .75 - .80)
Overload - Locked Rotor (Horsepower Rated Devices)	-	-	50 Operations @ 600% of Full Load Motor Current (p.f. = .40 - .50)
Short Circuit Withstand	-	-	≥ 10 kA ⁺ (600V and ≤ .50 power factor)
Short Circuit Make	-	-	≥ 10 kA ⁺ (600V and ≤ .50 power factor)

¹ Testing alternates between mechanical & electrical operations. This reduces the severity of the electrical test by allowing additional cooling time during electrical testing.

⁺ All MELTRIC Switch-Rated devices are UL listed with short circuit ratings of at least 65kA achieved at 600VAC and ≤ .15 power factor.



Benefit from using MELTRIC Switch-Rated Devices...

Ensure Worker Safety

Switch-Rated plugs and receptacles ensure safety by eliminating hazards associated with pin & sleeve and twist-type devices.

- ▶ The integral switching function ensures that the plug contacts are deenergized before an operator can remove the plug from the receptacle. The dead front design prevents unintended access to live parts.
- ▶ Spring-loaded, silver-nickel butt style contacts maintain proper contact force, withstand arcing, resist wear, and maintain low contact resistance. This ensures the integrity of the connection over thousands of operations and eliminates performance and safety problems common to plugs with brass contacts.
- ▶ Spring-loaded plug and receptacle disengagement with push button operation ensures fast and easy load breaking, which minimizes arcing during disconnection. Enclosed arc chambers eliminate the possibility of external arcs that could be a safety hazard for the operator.
- ▶ Horsepower, switch and short circuit ratings provide additional protection during locked-rotor or other significant overload situations.



Simplify Code Compliance

Switch-Rated devices provide a simple and cost effective means of helping facilities to achieve compliance with the National Electric Code and NFPA 70E.

NEC Compliance

Articles 430.101 to 430.113 of the National Electrical Code regulate the means of motor disconnection (Canadian Electrical Code section 28-600-28-604). They require motors to have readily accessible, 'line of sight' disconnects that are an approved switch or a properly rated plug and receptacle.

- ▶ **430.102** A disconnecting means must be located in sight of the motor and driven equipment.
- ▶ **430.107** The disconnecting means must be readily accessible.
- ▶ **430.109** The disconnecting means must be an approved switch or horsepower rated plug & receptacle.

MELTRIC Switch-Rated plugs and receptacles are both horsepower and switch-rated. Thus, they can function as a 'line of sight' disconnect in addition to providing a convenient plug and play power connection for the motor. By installing a Switch-Rated device, the need for an auxiliary disconnect switch is eliminated.

NFPA 70E (CSA Z462)

This OSHA consensus standard covers electrical safety related work practices and procedures for employees who work on or near exposed energized electrical conductors or other live circuit parts. Relevant requirements include:

Power must be proven to be off before work can be performed. This requires:

- ▶ The safe interruption of the load & opening of the disconnect
- ▶ Visual verification/voltage testing to ensure deenergization

The potential electrical hazard must be identified and documented.

- ▶ An arc flash risk assessment must be performed
- ▶ Flash protection boundaries must be determined

Appropriate steps must be taken to protect persons working near live parts or within the flash protection boundary.

- ▶ PPE must be worn based on incident energy exposure levels (cal/cm²)
- ▶ Only properly qualified persons are allowed to perform work

...Throughout your Facility

Wiring and connection systems utilizing conventional switches and/or pin & sleeve devices would typically require all of the previously listed protective measures to comply with NFPA 70E or CSA Z462. By using MELTRIC Switch-Rated plugs and receptacles to connect equipment, users can very simply comply with these requirements.

Switch ratings ensure the safe interruption of the load. Visual verification that the power is off is provided when the plug is removed from the receptacle. A dead front design prevents an operator from being exposed to live parts, eliminating the need to perform hazard analysis, establish flash protection boundaries and use electrical personal protective equipment.

A Comparison of the Motor Change-Out Process

MOTOR HARD-WIRED TO A BLADED DISCONNECT SWITCH	MOTOR CONNECTED WITH A MELTRIC MOTOR PLUG	MOTOR CONNECTED WITH A COMPETING PLUG & RECEPTACLE
<p>The disconnect switch may be difficult to install in "line of sight" of the motor.</p> <p>18"</p> <p>Qualified Worker w/PPE</p>	<p>OR</p> <ul style="list-style-type: none"> ▶ Cord connection allows easy "line of sight" location ▶ Dead front eliminates access to live parts and need for cumbersome PPE ▶ Ability to safely make & break under load eliminates the need for interlocks ▶ $\geq 65\text{kA}$ short circuit make-and-withstand rating ensures safety during reenergization <p>OR</p>	<ul style="list-style-type: none"> ▶ Expensive mechanical interlocks are required since these plugs & receptacles cannot safely make & break under load ▶ The interlock must be mounted on a fixed surface this may make "line of sight" location more difficult
MOTOR CHANGE-OUT PROCESS	MOTOR CHANGE-OUT PROCESS	MOTOR CHANGE-OUT PROCESS
<ol style="list-style-type: none"> 1. Switch disconnect to OFF position 2. Apply lockout/tagout 3. Perform Shock/Arc Flash Risk Assessment 4. Obtain permit for energized electrical work 5. Suit up with appropriate PPE 6. Remove the disconnect switch cover 7. Voltage test to verify deenergization 8. Disconnect motor from hard-wiring 9. Remove old/install new motor 10. Connect new motor to hard-wiring 11. Jog the motor to ensure proper rotation 	<ol style="list-style-type: none"> 1. Depress the pawl on the receptacle to break the circuit. 2. Mechanic removes plug from receptacle 3. Apply lockout/tagout as required 4. Mechanic removes old /installs new motor 5. Mechanic inserts plug into receptacle <p>MELTRIC Makes it Safe & Easy</p>	<ol style="list-style-type: none"> 1. Open interlock switch 2. Determine PPE requirements and obtain permit for electrical work 3. Remove interlock cover 4. Verify deenergization with a voltmeter test 5. Remove plug 6. Apply lockout/tagout as required 7. Remove old/install new motor 8. Insert plug into receptacle

Reduce Equipment & Installation Costs

The ability of MELTRIC Switch-Rated devices to safely make and break under full load eliminates the need for the expensive interlocks that are required with pin and sleeve devices. Their ability to function as the NEC required 'line of sight' disconnect switch eliminates the need for auxiliary disconnect switches. Optional pilot contacts can eliminate the need of auxiliary connectors in control circuits.

Reduce Equipment Change-out Downtime & Cost

Using MELTRIC Switch-Rated plugs and receptacles to connect motors and other equipment instead of hard-wiring can help reduce equipment change-out time by as much as 50%. With new motors pre-wired with MELTRIC plugs or inlets, the only electrical connection required during the change-out will be to plug in the new motor. Thus, a mechanic will be able to perform the change-out without the immediate aid of an electrician. This avoids the inconvenience of scheduling an electrician for a service call. So, extra downtime required to do the wiring is eliminated. The pre-wiring of replacement motors with MELTRIC plugs or inlets can be done off-site and during the convenience of non-downtime periods. This makes MELTRIC plugs and receptacles an ideal choice for 'plug and play' and modular process applications.

Selecting the Right MELTRIC Switch-Rated Plug & Receptacle

All Switch-Rated devices (DSN, DS and DB) feature:



- ▶ UL & CSA switch-ratings
- ▶ Short circuit closing and withstand protection (65kA to 100kA)



DSN Series (pages 23-36)

Choose DSN Series for its...

- ▶ Compact, lightweight design
- ▶ Automatic Type 4X watertightness
- ▶ High HP Ratings (up to 75 hp)

Common Applications

- ▶ Wet or washdown environments
- ▶ Plug & play electrical connections

DECONTACTOR™ Technology



- ▶ Silver-nickel contact material
- ▶ Spring-loaded, butt-style contacts



DS Series (pages 37-54)

Choose DS Series for its...

- ▶ High amperage range (up to 200A)
- ▶ Poly or metal casing materials (60A and above)
- ▶ Larger conductor capacities

Common Applications

- ▶ Heavy industry
- ▶ High amperage equipment

DECONTACTOR™ Technology



- ▶ Dead front safety shutter
- ▶ Optional auxiliary contacts



DB Series (pages 55-68)

Choose DB Series for its...

- ▶ High HP ratings (up to 60 hp)
- ▶ Robust, heavy duty construction

Common Applications

- ▶ Motors with frequent make and break requirements
- ▶ Harsh environments

DSN Models and Ratings

Model	Casing Material	Maximum Voltage (VAC)	Amperage Rating	Maximum Number of Contacts		Environmental Rating	Maximum Horsepower Rating	
				Main	Auxiliary		480 VAC	600 VAC
DSN20	Poly	600 VAC	20A	3P+N+G	–	Type 4X IP66/IP67	5 hp	5 hp
DSN30	Poly	600 VAC	30A	3P+N+G	2	Type 4X IP66/IP67	10 hp	15 hp
DSN60	Poly	600 VAC	60A	3P+N+G	4	Type 4X IP66/IP67	20 hp	20 hp
DSN150	Poly or Metal	600 VAC	150A	3P+N+G	6	Type 4X IP66/IP67	75 hp	75 hp

DS Models and Ratings

Model	Casing Material	Maximum Voltage (VAC)	Amperage Rating	Maximum Number of Contacts		Environmental Rating	Maximum Horsepower Rating	
				Main	Auxiliary		480 VAC	600 VAC
DS20	Poly	600 VAC	20A	3P+N+G	2	Type 3R	7.5 hp	10 hp
DS30	Poly	600 VAC	30A	3P+N+G	4	Type 3R	15 hp	15 hp
DS60	Poly or Metal	600 VAC	60A	3P+N+G	3	Type 3R	20 hp	25 hp
DS100C	Poly or Metal	600 VAC	100A	3P+N+G	3	Type 3R (Metal) Type 4X (Poly)	25 hp	25 hp
DS100	Poly or Metal	600 VAC	100A	3P+N+G	6	Type 3R	30 hp	–
DS200	Metal	480 VAC	200A	3P+N+G	5	Type 3R	–	–

DB Models and Ratings

Model	Casing Material	Maximum Voltage (VAC)	Amperage Rating	Maximum Number of Contacts		Environmental Rating	Maximum Horsepower Rating	
				Main	Auxiliary		480 VAC	600 VAC
DB30	Zinc Aluminum	600 VAC	30A	3P+N+G	2	IP67	20 hp	25 hp
DB60	Zinc Aluminum	600 VAC	60A	3P+N+G	2	IP67	30 hp	30 hp
DB100	Zinc Aluminum	600 VAC	100A	3P+N+G	4	IP67	60 hp	60 hp

DSN



Features and Ratings	p. 24
DSN20	p. 25
DSN30	p. 27
DSN60	p. 29
DSN150	p. 31
Spare parts	p. 33
Dimensions	p. 35



Switch-Rated plug and receptacle with Type 4X protection

DSN Series products are switch and hp rated for quick, safe equipment changeouts. DSN's are ideal for wet environments since they offer Type 4X watertightness as soon as the plug is connected to the receptacle or the lid is closed.

Main Advantages

- ▶ Switch & Hp rated
- ▶ 100 kA short circuit rated*
- ▶ Type 4X or IP66/IP67
- ▶ Compact, lightweight design
- ▶ Up to 6 auxiliary contacts

Highlighted Advantage

Simplify Compliance to
NFPA 70E & CSA Z462

See pgs 19-20 for
more information



* See note under General Ratings on the next page.

Product Features

DECONTACTOR™ Technology

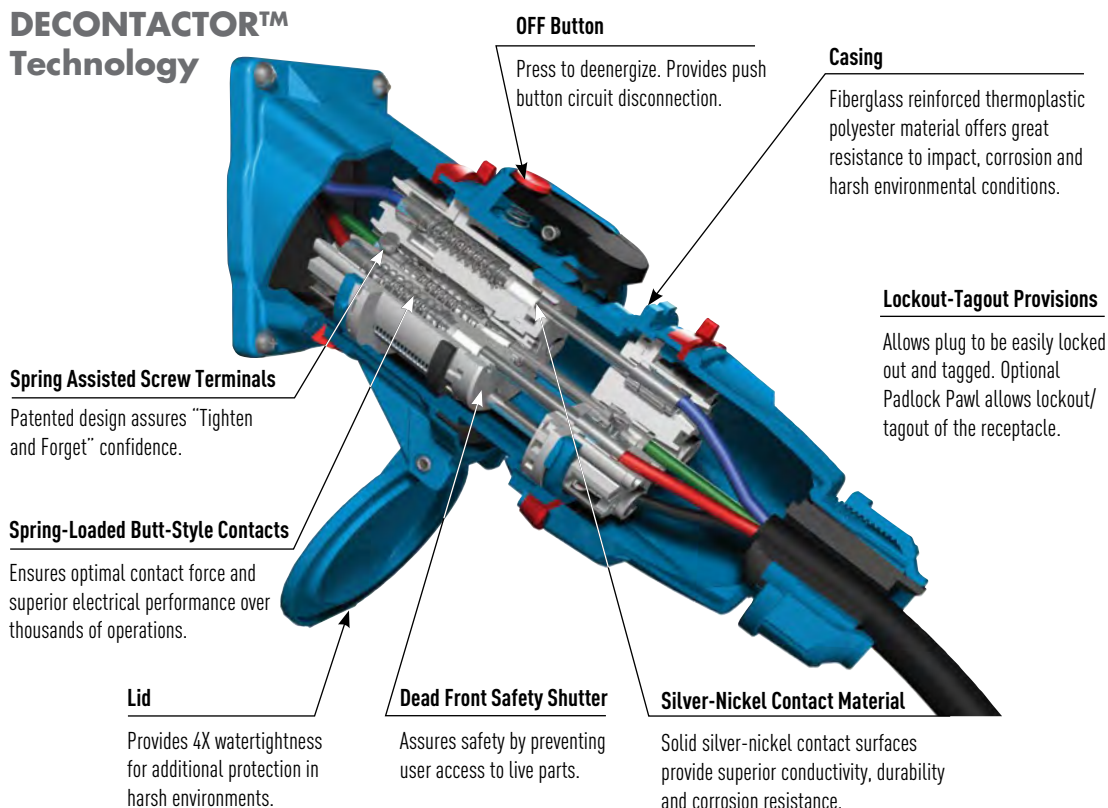

General Ratings

Amperage	20 to 150A
Voltage	600 VAC
Frequency	50-400 Hz (Not UL listed above 60 Hz)
Horsepower	1/2 to 75 hp
Short-Circuit (Make & Withstand)	100kA*
Environmental	Type 4X
Temperature	min -40°F/max 140°F

* DSN20, DSN30, DSN60: Testing was performed with RK1 current limiting fuses sized at 400% or more of the highest full load motor ampacity associated with the devices horsepower ratings.
 * DSN150: 100kA testing was performed with 225A RK1 non-time delay Mersen fuses. 10kA testing was performed with 400A RK1 non-time delay Mersen fuses.

Listings

Category	UL	CSA	IEC
Plugs and Receptacles	UL 1682	C22.2 No. 182.1	60309-1
Branch Circuit Disconnect Switching (AC only)	UL Subject 2682 (Performance tests from UL 98)	UL Subject 2682	60947-3, AC22, AC23
Motor Circuit Disconnect Switching (AC only)	UL Subject 2682 (Performance tests from UL 508)	UL Subject 2682	

CE ratings available upon request.

Operating Instructions



When the plug and receptacle are latched together, the circuit is connected.



Pressing the pawl breaks the connection and opens the circuit. The plug is ejected to its rest position; The contacts are now dead.



Rotating the 'dead' plug 30° counterclockwise closes the safety shutter and frees the plug to be withdrawn from the receptacle.



The plug and the receptacle are separated. The safety shutter prevents access to live parts.

5 To reconnect, insert plug into receptacle, rotate 30° clockwise, and apply insertion force.

Highlighted Feature

Typical Device Labels

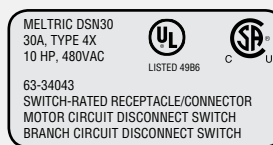

Meltric DSN Series Switch-Rated devices are UL & CSA rated for "motor circuit" and "branch circuit" disconnect switching – up to 75 hp and up to 150A.

DSN20



DSN – 20A Switch-Rated Plugs & Receptacles

UL/CSA Ratings

- Max Amperage & Voltage**
20A, 600 VAC
- Switch-Rating (AC Only)**
Branch Circuit & Motor Circuit Disconnect Switching
- Horsepower Ratings**

120V	1Ø	1/2 hp
240V	1Ø	1 1/2 hp
208V	3Ø	2 hp
240V	3Ø	2 hp
480V	3Ø	5 hp
600V	3Ø	5 hp
- Short Circuit Rating**
100kA Close & Withstand
Testing was performed with RK1 current limiting fuses sized at 400% of the highest full load motor ampacity associated with the devices hp rating.
- Environmental Ratings**
Type 4X*
*Also meets IP66/IP67 requirements
- Temperature Range**
Min -40°F / Max 140°F
See pg 234 for temps below -15°F.
- Wiring Capacity**
Min 14 AWG Max 12 AWG
- Applicable Standards**
UL 2682, UL 1682, CSA 182.1

Receptacle (female)



Don't forget to add installation accessories to your order

Inlet (male)



North American UL/CSA Configurations

Voltage	Polarity	Part # Poly
120V	1P+N+G	63-14165
120/208V	3P+N+G	63-14167
125V	1P+N+G	63-14075
125/250V	2P+N+G	63-14076
208V	2P+G	63-14162
208V	3P+G	63-14163
250V	2P+G	63-14072
250V	3P+G	63-14073
277V	1P+N+G	63-14045
277/480V	3P+N+G	63-14047
347/600V	3P+N+G	63-14147
480V	2P+G	63-14042
480V	3P+G	63-14043
600V	2P+G	63-14142
600V	3P+G	63-14143

Voltage	Polarity	Part # Poly
120V	1P+N+G	63-18165
120/208V	3P+N+G	63-18167
125V	1P+N+G	63-18075
125/250V	2P+N+G	63-18076
208V	2P+G	63-18162
208V	3P+G	63-18163
250V	2P+G	63-18072
250V	3P+G	63-18073
277V	1P+N+G	63-18045
277/480V	3P+N+G	63-18047
347/600V	3P+N+G	63-18147
480V	2P+G	63-18042
480V	3P+G	63-18043
600V	2P+G	63-18142
600V	3P+G	63-18143

For international configurations and ratings (IEC, CE) visit meltric.com/international-catalog or contact customer service at 800.433.7642.

Main Options



Mushroom Pawl



Padlock Pawl



Closed Lid Configuration

Recommended for cord applications to keep lid tucked in to avoid damage.

Receptacle Options

Suffix

Straight Insertion	Recept # - 352
Self-Ejecting Connector Release	Recept # - 354
Mushroom Pawl	Recept # - 375
Padlock Pawl	Recept # - 843
Padlockable Mushroom Pawl	Recept # - 375-843
Metal Pawl	Recept # - 824
Closed Lid Configuration	Recept # - NC

Inlet Options

Suffix

Self-Ejecting Plug Release	Inlet # - 338
With No Lockout Hole	Inlet # - A155

480V DSN20 Order Example:

To order a receptacle with a padlock pawl add **-843** the receptacle part number.

DSN20 receptacle 3P+G= 63-14043-**843**

Appropriate accessory numbers must also be included on the order.

How to Order

Receptacle and Inlet (see above)



Angle, Handle, Plug Cap, etc (see opposite page)



See pgs 211-220 for detailed information on these options

Installation Accessories

Handles



NPT	Poly Handle	Cable Range	Nylon Handle	Extended Handle	Angled Handle
1/2"	61-1A013-12	.20 - .82	-	61-1A413	-
3/4"	61-1A013-34	.35 - .70	61-1A013	-	61-1A313
1"	61-1A013-1				

- Notes:**
- Finger draw plates are recommended for easier connector closure on cord to cord assemblies.
 - For available cord grips, see pgs 169-170.

- For a guideline of NPT sizes based on cable ranges, see DSN30 on pg 28.

Angles



Metal 45° Angle	Nylon 30° Angle for MB Box	Metal 30° Angle for FS Box	Metal Straight Adapter
MA1	61-1A027-601	MAFS1*	MS1

* MAFS1 base measures approximately 4.2" x 2.7". Due to the variation in sizes of FS boxes, please verify that your FS box matches our dimensions, if not call Customer Service for other solutions.

Accessory Spotlight

Recommended Screwdriver

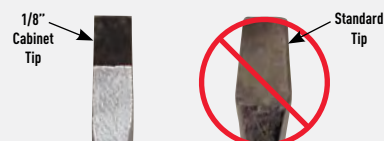

DSN20 terminal screws can be tightened or loosened with a 1/8" cabinet tip screwdriver. MELTRIC recommends Klein 608 Series or equal. The terminal screws on DSN20 devices **cannot** be properly accessed with a standard screwdriver.

Junction Boxes



NPT	Metal Box	Metal Box with Nylon Angle	Poly Conduit Entry	Poly 70° Wall Box	Poly 70° Alum Wall Box
1/2"	MB312	61-1A053-080-12	61-1A023-12	51-AA058	59-AA058-12
3/4"	MB334	61-1A053-080-34	61-1A023-34	51-AA058	59-AA058-34
1"	MB31	61-1A053-080-1	-	51-AA058	59-AA058-1
1 1/4"	MB3114	61-1A053-080-114	-	51-AA058	59-AA058-114
1 1/2"	-	-	-	-	59-AA058-112

* 70° poly boxes are not drilled. Contact customer service if factory drilling is required.
 † Interior volume with receptacle installed.

Miscellaneous Accessories



* Set of Two (2)



For Male Devices Only



For Male Devices Only



SD18**



Mount to existing boxes



LP-843

Finger Drawplates	Protective Cap	Padlockable Plug Cap	Screwdriver for Terminal Screws	Easy Retrofit Adapter Plates	Receptacle Locking Pin
61-1A346	61-1A426	61-1A826	SD18**	see pg 166	LP-843

* Recommended for cord to cord assembly applications, for easier connector closure.
 ** Requires Padlockable Pawl option (-843) on receptacle.

Order Example

A typical order should include an inlet part number, a receptacle part number **AND** the matching handles, angles or other required accessories.



Male Inlet with Handle (Plug)
63-18043 + 61-1A013



Female Receptacle with Angle Adapter
63-14043 + 61-1A027

DSN30

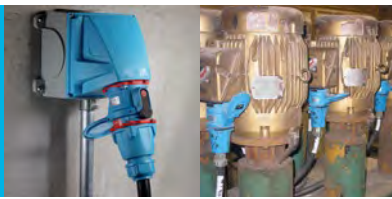

DSN – 30A Switch-Rated Plugs & Receptacles

UL/CSA Ratings

- Max Amperage & Voltage**
30A, 600 VAC
- Switch-Rating (AC Only)**
Branch Circuit & Motor Circuit Disconnect Switching
- Horsepower Ratings**

120V	1Ø	1 hp
240V	1Ø	3 hp
208V	3Ø	5 hp
240V	3Ø	5 hp
480V	3Ø	10 hp
600V	3Ø	15 hp
- Short Circuit Rating**
100kA Close & Withstand
Testing was performed with RK1 current limiting fuses sized at 400% of the highest full load motor ampacity associated with the devices hp rating.
- Environmental Ratings**
Type 4X*
* Also meets IP66/IP67 requirements
- Temperature Range**
Min -40°F/Max 140°F
See pg 234 for temps below -15°F.
- Wiring Capacity**
Min 14 AWG Max 8 AWG
Aux Contacts - 14 AWG
- Applicable Standards**
UL 2682, UL1682, CSA 182.1

Receptacle (female)



Don't forget to add installation accessories to your order

Inlet (male)



North American UL/CSA Configurations

Voltage	Polarity	Part # Poly
120V	1P+N+G	63-34165
120/208V	3P+N+G	63-34167
125V	1P+N+G	63-34075
125/250V	2P+N+G	63-34076
208V	2P+G	63-34162
208V	3P+G	63-34163
250V	2P+G	63-34072
250V	3P+G	63-34073
277V	1P+N+G	63-34045
277/480V	3P+N+G	63-34047
347/600V	3P+N+G	63-34147
480V	2P+G	63-34042
480V	3P+G	63-34043
600V	2P+G	63-34142
600V	3P+G	63-34143

Voltage	Polarity	Part # Poly
120V	1P+N+G	63-38165
120/208V	3P+N+G	63-38167
125V	1P+N+G	63-38075
125/250V	2P+N+G	63-38076
208V	2P+G	63-38162
208V	3P+G	63-38163
250V	2P+G	63-38072
250V	3P+G	63-38073
277V	1P+N+G	63-38045
277/480V	3P+N+G	63-38047
347/600V	3P+N+G	63-38147
480V	2P+G	63-38042
480V	3P+G	63-38043
600V	2P+G	63-38142
600V	3P+G	63-38143

For international configurations and ratings (IEC, CE) visit meltric.com/international-catalog or contact customer service at 800.433.7642.

Main Options



Auxiliary/Pilot Contacts



Mushroom Pawl



Padlock Pawl



Closed Lid Configuration
Recommended for cord applications to keep lid tucked in to avoid damage.

Receptacle Options

Suffix

With 2 Auxiliary/Pilot Contacts	Recept # - 972
Straight Insertion	Recept # - 352
Self-Ejecting Connector Release	Recept # - 354
Mushroom Pawl	Recept # - 375
Padlock Pawl	Recept # - 843
Padlockable Mushroom Pawl	Recept # - 375-843
Metal Pawl	Recept # - 824
Closed Lid Configuration	Recept # - NC
With Auxiliary Switch	Recept # - 270*

Notes: * Not UL/CSA Listed

480V DSN30 Order Example:

To order 2 auxiliary contacts on an inlet and receptacle add -972 to the part numbers.

DSN30 Inlet 3P+G = 63-38043-972

DSN30 Receptacle 3P+G = 63-34043-972

Appropriate accessory part numbers must also be included on the order.

Inlet Options

Suffix

With 2 Auxiliary/Pilot Contacts	Inlet # - 972
Self-Ejecting Plug Release	Inlet # - 338
With No Lockout Hole	Inlet # - A155
For Auxiliary Switch*	Inlet # - NNF

Notes: * Order inlet with P+N+G configuration and receptacle with P+G configuration.

How to Order

Receptacle and Inlet (see above)

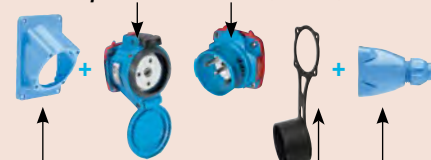

Angle, Handle, Plug Cap, etc (see opposite page)



See pgs 211-220 for detailed information on these options

Installation Accessories

Handles



NPT	Poly Handle	Cable Range	Nylon Handle	Poly Handle w/Clamp & Bushing
1/2"	61-3A013-12	.20 - .82	61-3A013	-
3/4"	61-3A013-34	.750 - .875	-	1PM514
1"	61-3A013-1	.875 - 1.000	-	1PM516
1 1/4"	61-3A013-114	1.000 - 1.125	-	1PM518
		1.125 - 1.250	-	1PM520
		1.250 - 1.375	-	1PM522

- Notes:**
- Finger draw plates are recommended for easier connector closure on cord to cord assemblies.
 - For available cord grips, see pgs 169-170.

NPT Guidelines

Cable Range	NPT
.312 - .625	1/2"
.438 - .812	3/4"
.660 - 1.000	1"
.875 - 1.375	1 1/4"

NPT sizes are determined by the cable diameter and third party cord grip.

Angles



Nylon 30° Angle	Metal 30° Angle	Metal Angle FS/FD Box 30°	Metal Straight Adapter
61-3A027	MA2	MAFS2*	MS2

* MAFS2 base measures approximately 4.2" x 2.7". Due to the variation in sizes of FS boxes, please verify that your FS box matches our dimensions, if not call Customer Service for other solutions.

Junction Boxes



NPT	Metal Box	Metal Box with Nylon Angle	Poly Conduit Entry	Poly 70°* Wall Box	Poly 70° Alum Wall Box
1/2"	MB312	61-3A053-080-12	61-3A023-12	51-BA058	59-BA058-12
3/4"	MB334	61-3A053-080-34	61-3A023-34	51-BA058	59-BA058-34
1"	MB31	61-3A053-080-1	-	51-BA058	59-BA058-1
1 1/4"	MB3114	61-3A053-080-114	-	51-BA058	59-BA058-114
1 1/2"	-	-	-	-	59-BA058-112

* 70° poly boxes are not drilled. Contact customer service if factory drilling is required.
+ Interior volume with receptacle installed.

Miscellaneous Accessories



* Set of Two (2)



For Male Devices Only



For Male Devices Only



Screwdriver for Terminal Screws



Mount to existing boxes



Receptacle Locking Pin

Finger Drawplates	Protective Cap	Padlockable Plug Cap	Screwdriver for Terminal Screws	Easy Retrofit Adapter Plates	Receptacle Locking Pin
61-3A346	61-3A426	61-3A826	SD18**	see pg 166	LP-843

* Recommended for cord to cord assembly applications, for easier connector closure. ** Klein 608-3 1/8" cabinet tip screwdriver with 3" round shank. + Requires Padlockable Pawl option (-843) on receptacle.

Accessory Spotlight

Receptacle Locking Pin



A 5/16" locking pin can be ordered to securely lockout receptacles that include the 'padlockable pawl' option. The user can also utilize a lock with a 5/16" shank. Locks with smaller shanks will NOT securely lockout a receptacle pawl.

Order Example

A typical order should include an inlet part number, a receptacle part number **AND** the matching handles, angles or other required accessories.



Male Inlet with Handle (Plug)
63-38043 + 61-3A013



Female Receptacle with Angle Adapter
63-34043 + 61-3A027

DSN60

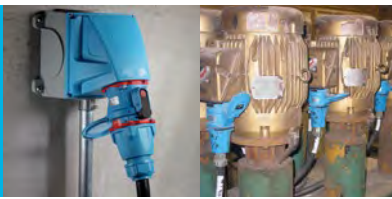

DSN – 60A Switch-Rated Plugs & Receptacles

UL/CSA Ratings

- **Max Amperage & Voltage**
60A, 600 VAC
- **Switch-Rating (AC Only)**
Branch Circuit & Motor Circuit Disconnect Switching
- **Horsepower Ratings**

120V	1Ø	2 hp
240V	1Ø	3 hp
208V	3Ø	7 1/2 hp
240V	3Ø	7 1/2 hp
480V	3Ø	20 hp
600V	3Ø	20 hp
- **Short Circuit Rating**
100kA Close & Withstand
Testing was performed with RK1 current limiting fuses sized at 400% of the highest full load motor ampacity associated with the devices hp rating.
- **Environmental Ratings**
Type 4X*
* Also meets IP66/IP67 requirements
- **Temperature Range**
Min -40°F/Max 140°F
See pg 234 for temps below -15°F.
- **Wiring Capacity**
Min 12 AWG Max 4 AWG
Aux Contacts - Max 14 AWG
- **Applicable Standards**
UL 2682, UL1682, CSA 182.1

Receptacle (female)



Inlet (male)



North American UL/CSA Configurations

Voltage	Polarity	Part # Poly
120V	1P+N+G	63-64165
120/208V	3P+N+G	63-64167
125V	1P+N+G	63-64075
125/250V	2P+N+G	63-64076
208V	2P+G	63-64162
208V	3P+G	63-64163
250V	2P+G	63-64072
250V	3P+G	63-64073
277V	1P+N+G	63-64045
277/480V	3P+N+G	63-64047
347/600V	3P+N+G	63-64147
480V	2P+G	63-64042
480V	3P+G	63-64043
600V	2P+G	63-64142
600V	3P+G	63-64143

Voltage	Polarity	Part # Poly
120V	1P+N+G	63-68165
120/208V	3P+N+G	63-68167
125V	1P+N+G	63-68075
125/250V	2P+N+G	63-68076
208V	2P+G	63-68162
208V	3P+G	63-68163
250V	2P+G	63-68072
250V	3P+G	63-68073
277V	1P+N+G	63-68045
277/480V	3P+N+G	63-68047
347/600V	3P+N+G	63-68147
480V	2P+G	63-68042
480V	3P+G	63-68043
600V	2P+G	63-68142
600V	3P+G	63-68143

For international configurations and ratings (IEC, CE) visit meltric.com/international-catalog or contact customer service at 800.433.7642.

Main Options

- Auxiliary/Pilot Contacts
- Mushroom Pawl
- Padlock Pawl
- Closed Lid Configuration
Recommended for cord applications to keep lid tucked in to avoid damage.

Receptacle Options

Receptacle Options	Suffix #
With 2 Auxiliary/Pilot Contacts	Recept # - 972
With 3 Auxiliary/Pilot Contacts	Recept # - 973
With 4 Auxiliary/Pilot Contacts	Recept # - 974
Straight Insertion	Recept # - 352
Self-Ejecting Connector Release	Recept # - 354
Mushroom Pawl	Recept # - 375
Padlock Pawl	Recept # - 843
Padlockable Mushroom Pawl	Recept # - 375-843
Metal Pawl	Recept # - 824
Closed Lid Configuration	Recept # - NC
With Auxiliary Switch	Recept # - 270*

Inlet Options

Inlet Options	Suffix #
With 2 Auxiliary/Pilot Contacts	Inlet # - 972
With 3 Auxiliary/Pilot Contacts	Inlet # - 973
With 4 Auxiliary/Pilot Contacts	Inlet # - 974
Self-Ejecting Plug Release	Inlet # - 338
With No Lockout Hole	Inlet # - A155
For Auxiliary Switch*	Inlet # - NNF

Notes: * Order inlet with P+N+G configuration and receptacle with P+G configuration.

Notes: + Not UL/CSA Listed

480V DSN60 Order Example:

To order 2 auxiliary contacts on an inlet and receptacle add **-972** to the part numbers.

DSN60 Inlet 3P+G = 63-68043-**972**

DSN60 Receptacle 3P+G = 63-64043-**972**

How to Order

Receptacle and Inlet (see above)



Accessories
Angle, Handle, Plug Cap, etc (see opposite page)



See pgs 211-220 for detailed information on these options

Installation Accessories



Makes connector closures easier

NPT	Poly Handle	Cable Range	Nylon Handle	Poly Handle w/Clamp & Bushing	Poly Handle w/built in Draw Grips
1/2"	61-6A013-12	.39 - 1.18	61-6A013	-	61-6A473
3/4"	61-6A013-34	.750 - .875	-	3PM514	-
1"	61-6A013-1	.875 - 1.000	-	3PM516	-
1 1/4"	61-6A013-114	1.000 - 1.125	-	3PM518	-
		1.125 - 1.250	-	3PM520	-
		1.250 - 1.375	-	3PM522	-

- Notes:**
- Finger draw plates are recommended for easier connector closure on cord to cord assemblies.
 - For available cord grips, see pgs 169-170.

- For a guideline of NPT sizes based on cable ranges, see DSN30 on pg 28.

Angles



Nylon 30° Angle	Metal 30° Angle	Metal 70° Angle	Metal Angle FS/FD Box 30°	Metal Straight Adapter
61-6A027	MA3	89-3A027	MAFS3*	MS3

* MAFS3 base measures approximately 4.2" x 2.7". Due to the variation in sizes of FS boxes, please verify that your FS box matches our dimensions, if not call Customer Service for other solutions.

Junction Boxes



29.6 in³⁺



13.5 in³⁺



185.7 in³⁺



170.0 in³⁺

NPT	Metal Box	Metal Box with Nylon Angle	Poly Conduit Entry	Poly 70°* Wall Box	Poly 70° Alum Wall Box
1/2"	MB312	61-6A053-080-12	61-6A023-12	51-CA058	59-CA058-12
3/4"	MB334	61-6A053-080-34	61-6A023-34	51-CA058	59-CA058-34
1"	MB31	61-6A053-080-1	61-6A023-1	51-CA058	59-CA058-1
1 1/4"	MB3114	61-6A053-080-114	-	51-CA058	59-CA058-114
1 1/2"	-	-	-	-	59-CA058-112

* 70° poly boxes are not drilled. Contact customer service if factory drilling is required.
+ Interior volume with receptacle installed.

Miscellaneous Accessories



* Set of Two (2)



For Male Devices Only



For Male Devices Only



Cord Grip with or w/o Mesh



Mount to existing boxes



Receptacle+ Locking Pin

61-6A346	61-6A426	61-6A826	see pgs 169-170	see pg 166	LP-843
----------	----------	----------	-----------------	------------	--------

* Recommended for cord to cord assembly applications, for easier connector closure.
+ Requires Padlockable Pawl option (-843) on receptacle.

Accessory Spotlight

Finger Drawplates



Finger drawplates are highly recommended for easier connector closure on cord to cord assemblies.

Order Example

A typical order should include an inlet part number, a receptacle part number **AND** the matching handles, angles or other required accessories.



Male Inlet with Handle (Plug)
63-68043 + 61-6A013



Female Receptacle with Angle Adapter
63-64043 + 61-6A027



DSN – 150A

Switch-Rated Plugs & Receptacles

UL/CSA Ratings

- **Max Amperage & Voltage**
150A, 600 VAC
- **Switch-Rating (AC Only)**
Branch Circuit & Motor Circuit Disconnect Switching
- **Horsepower Ratings**
 - 120V 1Ø 7 1/2 hp
 - 240V 1Ø 20 hp
 - 208V 3Ø 30 hp
 - 240V 3Ø 30 hp
 - 480V 3Ø 75 hp
 - 600V 3Ø 75 hp
- **Short Circuit Rating**
100kA Close & Withstand
Testing was performed with 225A RK1 non-time delay Mersen fuses.
10kA Close & Withstand
Testing was performed with 400A RK1 non-time delay Mersen fuses.
- **Environmental Ratings**
Type 4X*
*Also meets IP66/IP67 requirements
- **Temperature Range**
Min -40°F/Max 140°F
See pg 234 for temps below -15°F.
- **Wiring Capacity**
Min 4 AWG Max 2/0 AWG
Aux Contacts - Prewired w/14 AWG
- **Applicable Standards**
UL 2682, UL 1682, CSA 182.1

Receptacle (female)

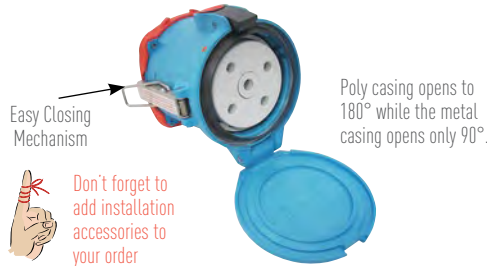

Inlet (male)

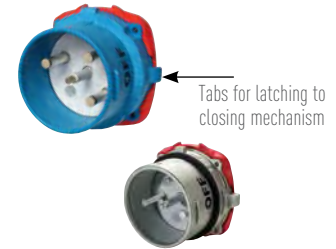

North American UL/CSA Configurations

Voltage	Polarity	Part #	
		Poly	Metal
120V	1P+N+G	63-94165	69-94165
120/208V	3P+N+G	63-94167	69-94167
125V	1P+N+G	63-94075	69-94075
125/250V	2P+N+G	63-94076	69-94076
208V	2P+G	63-94162	69-94162
208V	3P+G	63-94163	69-94163
250V	2P+G	63-94072	69-94072
250V	3P+G	63-94073	69-94073
277V	1P+N+G	63-94045	69-94045
277/480V	3P+N+G	63-94047	69-94047
347/600V	3P+N+G	63-94147	69-94147
480V	2P+G	63-94042	69-94042
480V	3P+G	63-94043	69-94043
600V	2P+G	63-94142	69-94142
600V	3P+G	63-94143	69-94143

Voltage	Polarity	Part #	
		Poly	Metal
120V	1P+N+G	63-98165	69-98165
120/208V	3P+N+G	63-98167	69-98167
125V	1P+N+G	63-98075	69-98075
125/250V	2P+N+G	63-98076	69-98076
208V	2P+G	63-98162	69-98162
208V	3P+G	63-98163	69-98163
250V	2P+G	63-98072	69-98072
250V	3P+G	63-98073	69-98073
277V	1P+N+G	63-98045	69-98045
277/480V	3P+N+G	63-98047	69-98047
347/600V	3P+N+G	63-98147	69-98147
480V	2P+G	63-98042	69-98042
480V	3P+G	63-98043	69-98043
600V	2P+G	63-98142	69-98142
600V	3P+G	63-98143	69-98143

For international configurations and ratings (IEC, CE) visit meltric.com/international-catalog or contact customer service at 800.433.7642.

Main Options

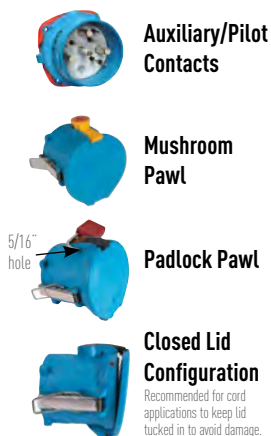

Receptacle Options

Receptacle Options	Suffix #
With 2 Auxiliary/Pilot Contacts	Recept # - 262
With 3 Auxiliary/Pilot Contacts	Recept # - 263
With 4 Auxiliary/Pilot Contacts	Recept # - 264
With 5 Auxiliary/Pilot Contacts	Recept # - 975
With 6 Auxiliary/Pilot Contacts	Recept # - 976
Straight Insertion	Recept # - 352
Self-Ejecting Connector Release	Recept # - 354
Mushroom Pawl	Recept # - 375
Padlock Pawl	Recept # - 843
Padlockable Mushroom Pawl	Recept # - 375-843
Locking Mushroom Pawl	Recept # - 845
Metal Pawl (on poly receptacle)	Recept # - 824
180° Opening Lid	Recept # - 180**
Closed Lid Configuration	Recept # - NC
With Auxiliary Switch	Recept # - 270***

Inlet Options

Inlet Options	Suffix #
With 2 Auxiliary/Pilot Contacts	Inlet # - 262
With 3 Auxiliary/Pilot Contacts	Inlet # - 263
With 4 Auxiliary/Pilot Contacts	Inlet # - 264
With 5 Auxiliary/Pilot Contacts	Inlet # - 975
With 6 Auxiliary/Pilot Contacts	Inlet # - 976
Self-Ejecting Plug Release	Inlet # - 338
With No Lockout Hole	Inlet # - A155
For Auxiliary Switch*	Inlet # - NNF

Notes: * Order inlet with P+N+G configuration and receptacle with P+G = configuration.

480V DSN150 Order Example:

To order 2 auxiliary/pilot contacts on an inlet and receptacle add **-262** to the part numbers.

DSN150 Poly inlet 3P+G=63-98043-**262**

DSN150 Poly receptacle 3P+G=63-94043-**262**

Appropriate accessory part numbers must also be included on the order.

Notes: ** Required when mating to rigid mounted male inlet.

*** Not UL/CSA listed.

i Metal devices only.

See pgs 211-220 for detailed information on these options

Installation Accessories

Unless indicated otherwise, accessories can be used with either poly or metal plugs and receptacles.

Handles



NPT	Poly Handle	Metal* Handle	Oversized* Metal Handle	Cable Range	Santoprene™ Handle	Poly Handle w/Clamp & Bushing
3/4"	9PH34	9H34	9MH34	.70 - 1.00	65-9A013-D25	-
1"	9PH1	9H1	9MH1	.984 - 1.377	65-9A013-D35	-
1 1/4"	9PH114	9H114	9MH114	1.250 - 1.375	-	9PM622
1 1/2"	9PH112	9H112	9MH112	1.377 - 1.771	65-9A013-D45	-
2"	9PH2	9H2	9MH2	1.438 - 1.562	-	9PM625
2 1/2"	-	-	9MH212	1.562 - 1.688	-	9PM627
				1.688 - 1.812	-	9PM629

- Notes:**
- For available cord grips, see pgs 169-170.
 - For a guideline of NPT sizes based on cable ranges, see DS30 on pg 42.
 - * For metal devices only.

Angles



Nylon 30° Angle	Metal 30° Angle	Metal 70° Angle	Metal Angle+ Oversized 30°	Metal Straight Adapter
MP10	MA10	89-9A027	MA110	MS10

+ Mounts on oversize box only. Order with MB22xxx box. See page 50.

Junction Boxes

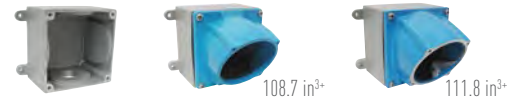

NPT	Metal Box	Metal Box with Nylon Angle	Metal Box with Metal Angle
1 1/4"	MB10114	31-9A053-080-114	39-9A053-080-114
1 1/2"	MB10112	31-9A053-080-112	39-9A053-080-112
2"	MB102	31-9A053-080-2	39-9A053-080-2
2 1/2"	MB10212	31-9A053-080-212	39-9A053-080-212

+ Interior volume with receptacle installed.

Miscellaneous Accessories



Protective Cap	Padlockable Cap Aluminum	Cord Grip with Mesh	Easy Retrofit Adapter Plates	Receptacle + Locking Pin
31-9A126	DS9MC	see pgs 169-170	see pg 166	LP-843

+ Requires Padlockable Pawl option (-843) on receptacle.

Feature Spotlight – Easy Closing Mechanism

A new and simplified closing mechanism is now standard on the DSN150, DS100 and DS200 plugs and receptacles. This compact mechanism enables easy connection of the plug to the receptacle.

- Notes:** After connection, the mechanism must be released to allow disconnection of the device.



The plug is partially inserted, clamps are placed around tab, ready to pull the plug into the receptacle.

The handles are pushed down, the plug is fully drawn into the receptacle.

Order Example

A typical order should include an inlet part number, a receptacle part number **AND** the matching handles, angles or other required accessories.



Male Inlet with Handle (Plug)
63-98043 + 9H34



Female Receptacle with Angle Adapter
63-94043 + MA10



Spare Parts Male Configuration

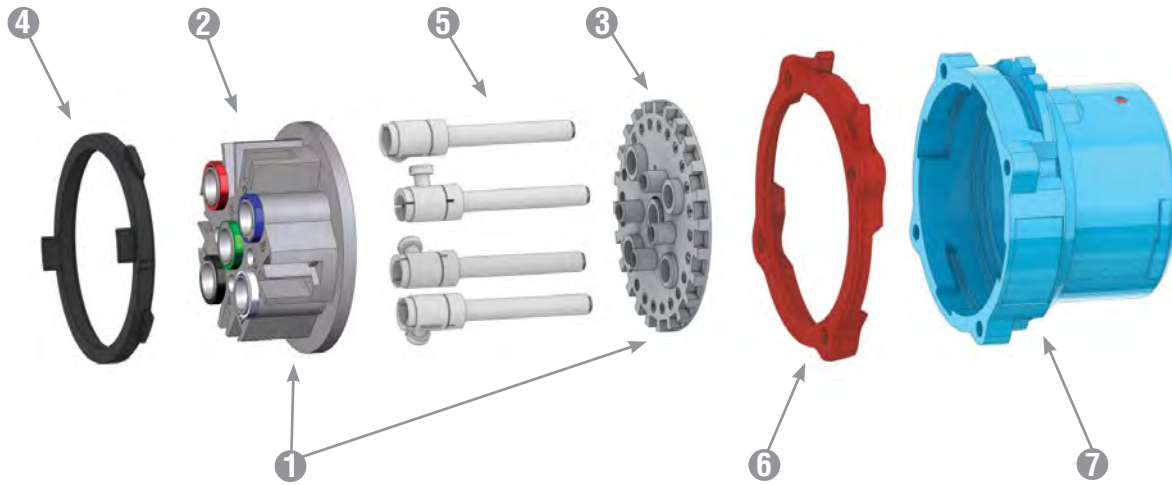

	DSN20 POLY	DSN30 POLY	DSN60 POLY	DSN150 POLY	DSN150 METAL	
1 = Plug Interior***	61-1A010*	61-3A010*	61-6A010*	63-9A010*	67-9A010*	
1 = Plug Interior with 2 pilots ⁺	-	61-3A310-972*	61-6A310-972*	63-9A310-262	67-9A310-262*	
2 = Interior Bottom***	61-1A010-B	61-3A010-B	61-6A010-B	63-9A551	67-9A551	
3 = Interior Top***	61-1A010-T*	61-3A010-T*	61-6A010-T*	63-9A010-T*	67-9A010-T*	
4 = Polyester Locking Ring	61-1A583	61-3A583	61-6A583	63-9A583	-	
4 = Metal Locking Ring	-	-	-	-	67-9A583	
5 = Plug Phase Contact (If no aux. contacts)	61-1A011	61-3A011-380	61-6A011	63-9A011	63-9A011	
5 = Plug Phase Contact (If plug has aux. contacts)	61-1A011	61-3A011	61-6A011	63-9A011	63-9A011	
5 = Plug Ground Contact	61-1A019	61-3A019	61-6A019	63-9A019	63-9A019	
6 = Color-Coded Voltage Gasket	<div style="display: flex; align-items: center;"> <div style="width: 15px; height: 10px; border-radius: 5px; background-color: #0056b3; margin-right: 5px;"></div> 208V </div> <div style="display: flex; align-items: center;"> <div style="width: 15px; height: 10px; border-radius: 5px; background-color: #e69d00; margin-right: 5px;"></div> 250V </div> <div style="display: flex; align-items: center;"> <div style="width: 15px; height: 10px; border-radius: 5px; background-color: #d62728; margin-right: 5px;"></div> 480V </div> <div style="display: flex; align-items: center;"> <div style="width: 15px; height: 10px; border-radius: 5px; background-color: #333; margin-right: 5px;"></div> 600V </div> <div style="display: flex; align-items: center;"> <div style="width: 15px; height: 10px; border-radius: 5px; background-color: #e69d00; margin-right: 5px;"></div> 125V </div>	61-1AB26	61-3AB26	61-6AB26	31-9AB26	39-2AB26
	61-1AC26	61-3AC26	61-6AC26	31-9AC26	39-2AC26	
	61-1AR26	61-3AR26	61-6AR26	31-9AR26	39-2AR26	
	61-1AN26	61-3AN26	61-6AN26	31-9AN26	39-2AN26	
	61-1AC26	61-3AC26	61-6AC26	31-9AC26	39-2AC26	
7 = Plug Polyester Casing	61-1A014**	61-3A014**	61-6A014**	63-9A014**	-	
7 = Plug Metal Casing	-	-	-	-	67-9A014	

* Voltage and phasing positions must be specified (5th, 6th & 7th digit of Part #) to duplicate your shutter and alignment notches.

** For appropriate labeling on a device, please specify voltage, phasing, and product type.

*** For interiors with pilot contacts, contact Customer Service for part numbers.

⁺ For interiors with more than 2 pilot contacts, contact Customer Service for part numbers.

Spare Parts Female Configuration

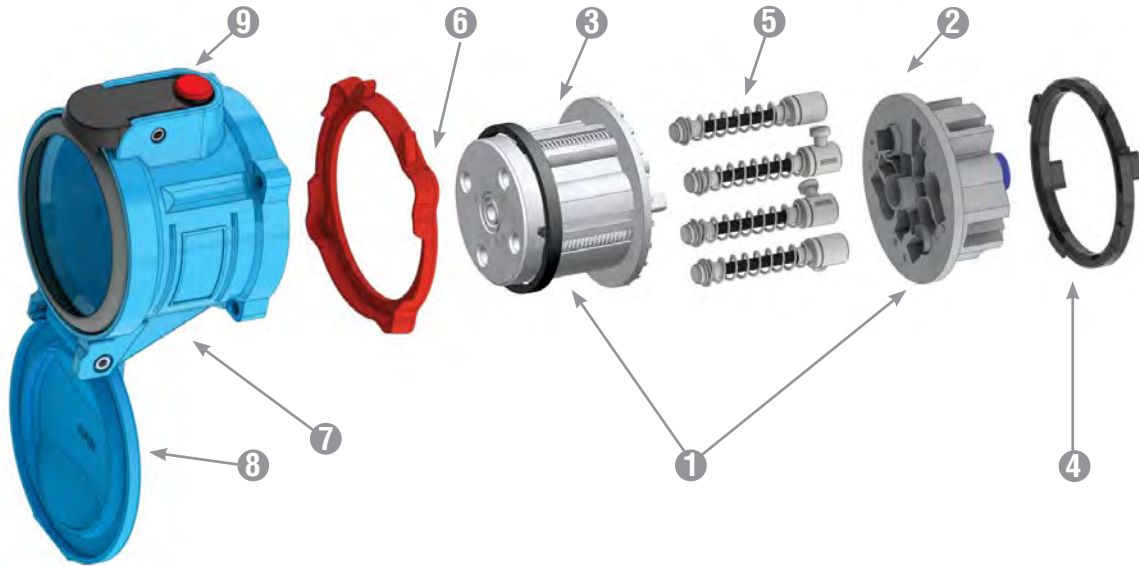

	DSN20 POLY	DSN30 POLY	DSN60 POLY	DSN150 POLY	DSN150 METAL
1 = Receptacle Interior***	61-1A020*	61-3A020*	61-6A020*	63-9A020*	67-9A020*
1 = Receptacle Interior with 2 pilots†	-	61-3A320-972*	61-6A320-972*	63-9A320-262*	67-9A320-262*
2 = Interior Bottom***	61-1A020-B	61-3A020-B	61-6A020-B	63-9A552	67-9A552
3 = Interior Top***	61-1A020-T*	61-3A020-T*	61-6A020-T*	63-9A020-T*	67-9A020-T*
4 = Polyester Locking Ring	61-1A583	61-3A583	61-6A583	63-9A583	-
4 = Metal Locking Ring	-	-	-	-	67-9A583
5 = Receptacle Phase Contact (If no aux. contacts)	61-1A021	61-3A021-380	61-6A021	63-9A021	63-9A021
5 = Receptacle Phase Contact (If plug has aux. contacts)	61-1A021	61-3A021	61-6A021	63-9A021	63-9A021
5 = Receptacle Ground Contact	61-1A029	61-3A029	61-6A029	63-9A029	67-9A029
6 = Color-Coded Voltage Gasket					
	61-1AB26	61-3AB26	61-6AB26	31-9AB26	31-9AB26
	61-1AC26	61-3AC26	61-6AC26	31-9AC26	31-9AC26
	61-1AR26	61-3AR26	61-6AR26	31-9AR26	31-9AR26
	61-1AN26	61-3AN26	61-6AN26	31-9AN26	31-9AN26
	61-1AC26	61-3AC26	61-6AC26	31-9AC26	31-9AC26
7 = Receptacle Polyester Casing	61-1A024**	61-3A024**	61-6A024**	63-9A024**	-
7 = Receptacle Metal Casing	-	-	-	-	67-9A024
8 = Lid Replacement Kit Polyester	61-1A125	61-3A125	61-6A125	63-9A125	-
8 = Lid Replacement Kit Metal	-	-	-	-	67-9A925
9 = Pawl Replacement Kit Polyester	61-1A824	61-3A824	61-6A824	61-9A824	-
9 = Pawl Replacement Kit Metal	69-1A824	69-6A924	69-6A924	69-9A924	67-9A824

* Voltage and phasing positions must be specified (5th, 6th & 7th digit of Part #) to duplicate your shutter and alignment notches.

** For appropriate labeling on a device, please specify voltage, phasing, and product type.

*** For interiors with pilot contacts, contact Customer Service for part numbers.

† For interiors with more than 2 pilot contacts, contact Customer Service for part numbers.



Dimensions

Inlet – Provided in inches

Dimensions are for reference only and may change depending on accessories used. For precise dimensions contact MELTRIC Engineering.

plug

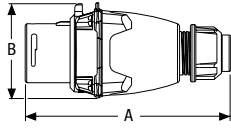

PRODUCT	A	B
DSN20	5.16	2.36
DSN30/DSN24	5.84	2.83
DSN60/DSN37	6.29	3.05
DSN150	8.09	4.79

Inlet with connector

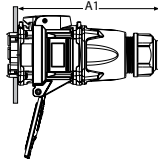

PRODUCT	A1
DSN20	5.63
DSN30/DSN24	6.78
DSN60/DSN37	7.32
DSN150	10.29

Inlet

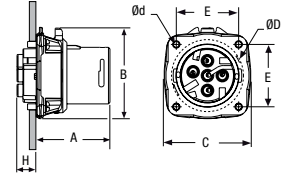

PRODUCT	A	B	C	E	H	Ød	ØD
DSN20	1.86	2.36	2.20	1.65	0.62	0.17	1.77
DSN30/DSN24	1.97	2.83	2.62	1.89	0.60	0.18	2.24
DSN60/DSN37	2.19	3.40	3.05	2.17	0.61	0.20	2.68
DS150	2.96	4.79	4.50	3.19	1.09	0.24	3.81

30° inclined inlet/angle with connector

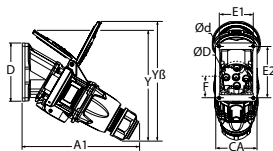

PRODUCT	A1	CA	D	E1	E2	F	Y	YB	Ød	ØD
DSN20	5.55	2.68	3.54	1.42	3.07	1.58	2.70	5.52	0.18	2.00
DSN30/DSN24	7.60	3.00	4.25	2.50	3.75	1.88	6.70	8.50	0.22	2.50
DSN60/DSN37	7.48	3.00	4.25	2.50	3.75	2.00	8.03	9.01	0.22	2.50
DSN150	12.34	5.57	5.57	4.83	4.83	2.31	11.34	11.34	0.28	4.72

30° inlet/angle

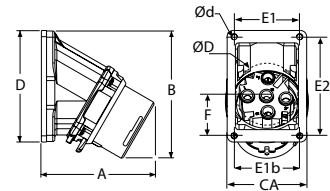

PRODUCT	A	B	CA	D	E1	E1b	E2	F	Ød	ØD
DSN20	3.13	4.91	2.68	3.54	1.42	2.20	3.07	1.58	0.18	2.00
DSN30/DSN24	3.66	4.63	3.00	4.25	2.50		3.75	1.88	0.22	2.50
DSN60/DSN37	4.00	4.82	3.00	4.25	2.50		3.75	2.00	0.22	2.50
DSN150	6.11	6.50	5.57	5.57	4.83		4.83		0.28	4.72

30° inclined inlet/angle/ junction box with connector

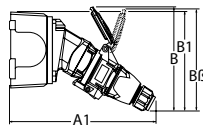

PRODUCT	A1	B	B1	Bβ
DSN20	7.80	6.38	6.06	
DSN30/DSN24	9.85	8.23	6.85	
DSN60/DSN37	9.73	7.81	7.13	9.06
DSN150	16.06	12.24	10.00	

inlet/angle/ metal junction box

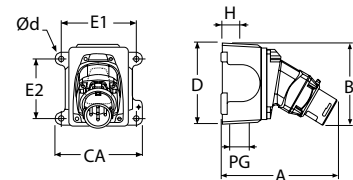

PRODUCT	A	B	CA	D	E1	E2	H	PG	Ød
DSN20	5.38	5.04	4.40	4.50	4.19*	2.75	1.10	1.00	0.25
DSN30/DSN24	5.91	4.77	4.40	4.50	4.19*	2.75	1.10	1.00	0.25
DSN60/DSN37	6.26	4.97	4.40	4.50	4.19*	2.75	1.10	1.00	0.25
DSN150	9.81	6.50	7.50	5.50	6.75	4.24	1.84	2.00	0.31

* Note: this dimension changed on 7/1/2014 from 3.75" to 4.19".

70° inclined inlet/wall box with connector

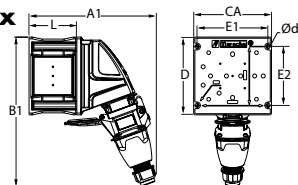

PRODUCT	A1	B1	CA	D	E1	E2	L	Ød
DSN20	8.11	9.41	5.04	5.04	4.57	3.78	3.07	0.26
DSN30/DSN24	8.70	10.55	5.04	5.04	4.57	3.72	3.07	0.26
DSN60/DSN37	9.52	12.60	6.69	6.69	6.14	5.43	3.07	0.26



Dimensions

Receptacle – Provided in inches

Dimensions are for reference only and may change depending on accessories used. For precise dimensions contact MELTRIC Engineering.

connector

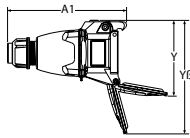

PRODUCT	A1	Y	YB
DSN20	5.41	3.21	5.30
DSN30/DSN24	6.74	4.46	7.13
DSN60/DSN37	7.18	5.36	8.18
DSN150	9.75	8.03	10.94

receptacle with plug

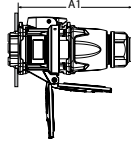

PRODUCT	A1
DSN20	5.63
DSN30/DSN24	6.78
DSN60/DSN37	7.32
DSN150	10.29

receptacle

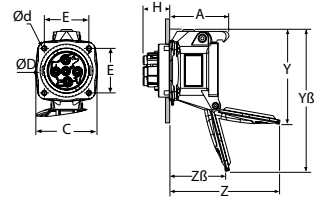

PRODUCT	A	C	E	H	Y	YB	Z	ZB	Ød	ØD
DSN20	2.12	2.20	1.65	0.98	3.50	5.19	4.05	2.09	0.17	2.00
DSN30/DSN24	2.87	2.89	1.89	0.65	4.65	7.01	5.07	2.17	0.18	2.24
DSN60/DSN37	3.12	2.27	2.17	0.73	5.32	8.12	5.73	2.43	0.19	2.68
DSN150	4.60	4.46	3.19	1.09	8.03	10.94	8.70	3.46	0.24	3.81

30° inclined receptacle/angle with plug

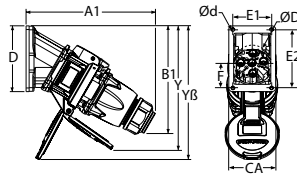

PRODUCT	A1	B1	CA	D	E1	E2	F	Y	YB	Ød	ØD
DSN20	5.52	7.48	2.68	3.54	1.42	3.07	1.58	7.00	7.10	0.18	2.00
DSN30/DSN24	7.60	6.73	3.00	4.25	2.50	3.75	1.88	6.70	8.50	0.22	2.50
DSN60/DSN37	8.24	7.01	3.00	4.25	2.50	3.75	2.00	8.06	9.02	0.22	2.50
DSN150	12.34	10.00	5.57	5.57	4.83	4.83	2.31	12.05	12.05	0.28	4.72

30° receptacle/angle

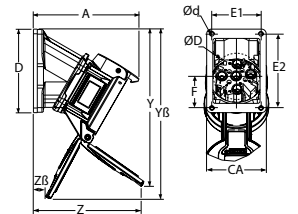

PRODUCT	A	CA	D	E1	E2	F	Y	YB	Ød	ØD
DSN20	3.84	2.68	3.54	1.42	3.07	1.58	7.13	7.10	0.18	2.00
DSN30/DSN24	4.76	3.00	4.25	2.50	3.75	1.88	7.50	8.35	0.22	2.50
DSN60/DSN37	5.23	3.00	4.25	2.50	3.75	2.00	7.99	9.04	0.22	2.50
DSN150	7.89	5.57	5.57	4.83	4.83	2.31	12.05	12.05	0.28	4.72

30° inclined receptacle/angle/ junction box with plug

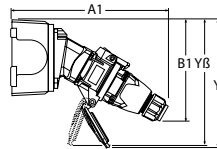

PRODUCT	A1	B1	Y	YB
DSN20	7.80	7.36	7.30	7.19
DSN30/DSN24	9.85	6.85	8.50	8.36
DSN60/DSN37	10.48	7.13	8.20	9.18
DSN150	16.06	9.53	11.77	11.77

receptacle/angle/ metal junction box

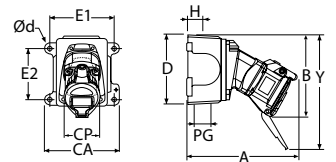

PRODUCT	A	B	CA	CP	D	E1	E2	H	PG	Y	Ød
DSN20	6.00	5.15	4.40	2.20	4.50	4.19*	2.75	1.10	1.00	7.25	0.25
DSN30/DSN24	7.00	5.67	4.40	2.48	4.50	4.19*	2.75	1.10	1.00	7.60	0.25
DSN60/DSN37	7.48	5.84	4.40	2.48	4.50	4.19*	2.75	1.10	1.00	8.20	0.25
DSN150	11.50	7.80	7.50	4.83	5.50	6.75	4.24	1.84	2.00	10.33	0.33

* Note: this dimension changed on 7/1/2014 from 3.75" to 4.19".

70° inclined receptacle/wall box with plug

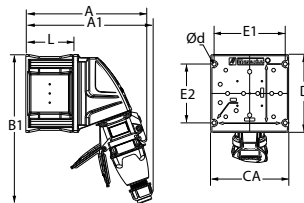

PRODUCT	A	A1	B1	CA	D	E1	E2	L	Ød
DSN20	7.25	8.11	9.41	5.04	5.04	4.57		3.07	0.26
DSN30/DSN24	8.16	8.70	10.55	5.04	5.04	4.57		3.07	0.26
DSN60/DSN37	9.36	9.52	12.60	6.69	6.69	6.14	5.43	3.07	0.26



DS



Features and Ratings	p. 38
DS20	p. 39
DS30	p. 41
DS60	p. 43
DS100C	p. 45
DS100	p. 47
DS200	p. 49
Spare parts	p. 51
Dimensions	p. 53



Switch-rated plugs and receptacles

DS Series products provide a useful combination of capacity and ruggedness. DS are often used to connect motors and welders in the metals, quarry, automotive, and mining industries. They are designed for applications requiring large wiring capacities. The DS's environmental rating is achieved as soon as the plug and receptacle are fully engaged, making them an excellent choice for outdoor applications where rainproof performance is required.

Main Advantages

- ▶ Switch & Hp rated (AC only)
- ▶ 65 kA to 100 kA short circuit rated*
- ▶ Up to 6 auxiliary contacts
- ▶ Amperage ratings up to 200A
- ▶ Metal or Poly construction

Highlighted Advantage

Simplify Compliance to
NFPA 70E & CSA Z462

See pgs 19-20 for
more information



* See note under General Ratings on the next page.

Product Features

DECONTACTOR™ Technology

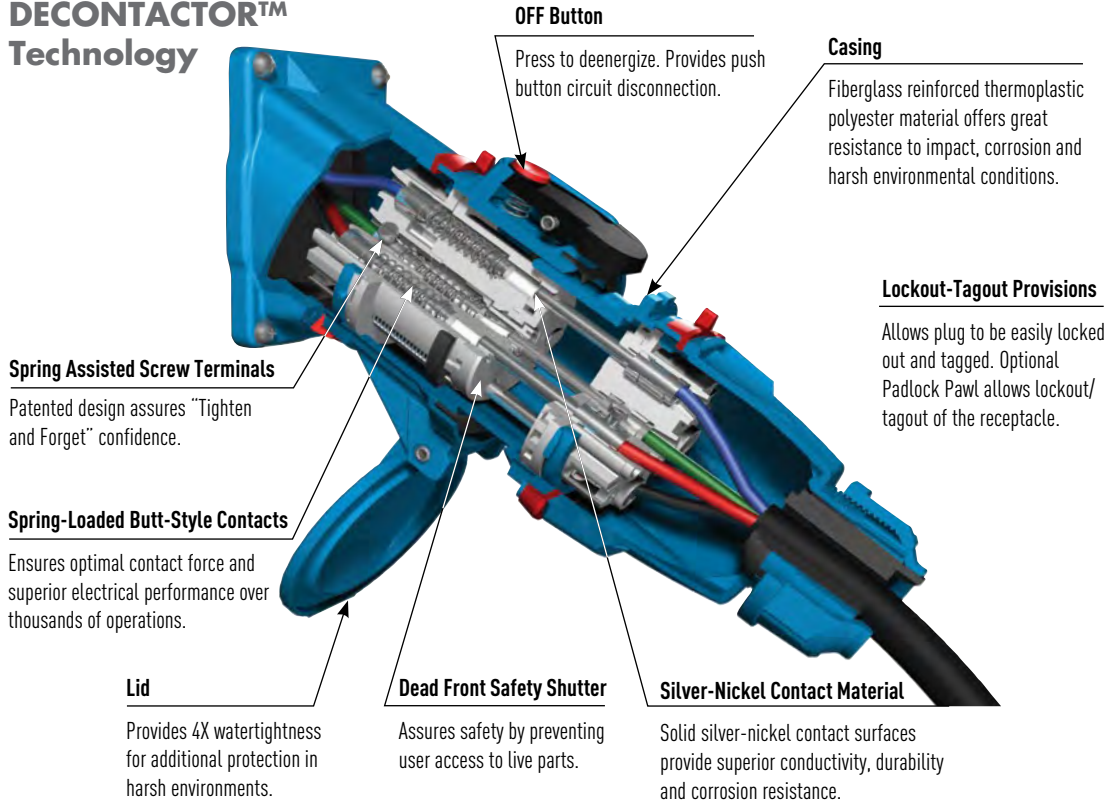

General Ratings

Amperage	20 to 200A
Voltage	600 VAC (480 VAC for DS200)
Frequency	50-400 Hz
Horsepower	3/4 to 30 hp
Short-Circuit (Make & Withstand)	65kA to 100kA*
Environmental	Type 3R, IP54/IP55**, Type 4X optional
Temperature	min -40°F/max 140°F

* DS20, 30, 60 & 100C are rated 100kA. Testing was performed with RK1 current limiting fuses sized at 400% of the highest full load motor ampacity associated with the devices hp rating.

* DS100 & 200 are rated 65kA. Testing was performed with RK5 time delay fuses sized at 100% of the devices rated ampacity.

** IP54 rated when receptacle and plug are mated, when not mated receptacle alone is IP55 rated provided that the lid is latched closed.

Listings

Category	UL	CSA	IEC
Plugs and Receptacles	UL 1682	C22.2 No. 182.1	60309-1
Branch Circuit Disconnect Switching (AC only)	UL Subject 2682 (Performance tests from UL 98)	UL Subject 2682	60947-3, AC22, AC23
Motor Circuit Disconnect Switching (AC only)	UL Subject 2682 (Performance tests from UL 508)	UL Subject 2682	

CE ratings available upon request.

Highlighted Feature

Typical Device Labels

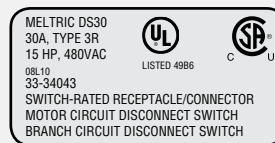

Meltric DS Series Switch-Rated devices are UL & CSA rated for "motor circuit" and "branch circuit" disconnect switching – up to 30 hp and up to 200A.

Operating Instructions



When the plug and receptacle are latched together, the circuit is connected.



Pressing the pawl breaks the connection and opens the circuit. The plug is ejected to its rest position. The contacts are now dead.



Rotating the 'dead' plug 30° counterclockwise closes the safety shutter and frees the plug to be withdrawn from the receptacle.

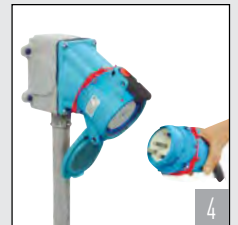

The plug and the receptacle are separated. The safety shutter prevents access to live parts.

5 To reconnect, insert plug into receptacle, rotate 30° clockwise, and apply insertion force.

DS20



DS – 20A Switch-Rated Plugs & Receptacles

UL/CSA Ratings

- **Max Amperage & Voltage**
20A, 600 VAC
- **Switch-Rating (AC Only)**
Branch Circuit & Motor Circuit Disconnect Switching
- **Horsepower Ratings**

120V	1Ø	3/4 hp
208V	3Ø	3 hp
240V	3Ø	5 hp
480V	3Ø	7 1/2 hp
600V	3Ø	10 hp
- **Short Circuit Rating**
100kA Close & Withstand
Testing was performed with RK1 current limiting fuses sized at 400% of the highest full load motor ampacity associated with the devices hp rating.
- **Environmental Ratings**
Type 3R, IP54/IP55*
* IP54 when the plug & receptacle are mated. IP55 on the receptacle alone when the lid is latched closed.
- **Temperature Range**
Min -40°F/Max 140°F
See pg 234 for temps below -15°F.
- **Wiring Capacity**
Min 14 AWG Max 8 AWG
Aux Contact - Max 14 AWG
- **Applicable Standards**
UL 2682, CSA 182.1

Receptacle (female)



Don't forget to add installation accessories to your order

Inlet (male)



North American UL/CSA Configurations

Voltage	Polarity	Part # Poly
120V	1P+N+G	33-14165
120/208V	3P+N+G	33-14167
125V	1P+N+G	33-14075
125/250V	2P+N+G	33-14076
208V	2P+G	33-14162
208V	3P+G	33-14163
250V	2P+G	33-14072
250V	3P+G	33-14073
277V	1P+N+G	33-14045
277/480V	3P+N+G	33-14047
347/600V	3P+N+G	33-14147
480V	2P+G	33-14042
480V	3P+G	33-14043
600V	2P+G	33-14142
600V	3P+G	33-14143

Voltage	Polarity	Part # Poly
120V	1P+N+G	33-18165
120/208V	3P+N+G	33-18167
125V	1P+N+G	33-18075
125/250V	2P+N+G	33-18076
208V	2P+G	33-18162
208V	3P+G	33-18163
250V	2P+G	33-18072
250V	3P+G	33-18073
277V	1P+N+G	33-18045
277/480V	3P+N+G	33-18047
347/600V	3P+N+G	33-18147
480V	2P+G	33-18042
480V	3P+G	33-18043
600V	2P+G	33-18142
600V	3P+G	33-18143

For international configurations and ratings (IEC,CE) visit meltric.com/international-catalog or contact customer service at 800.433.7642.

Main Options



Auxiliary/Pilot Contacts



Mushroom Pawl



Padlock Pawl



Closed Lid Configuration

Recommended for cord applications to keep lid tucked in to avoid damage.

Receptacle Options

Suffix

With 2 Auxiliary/Pilot Contacts	Recept # - 972
Type 4X & closed lid configuration	Recept # - 4X
Straight Insertion	Recept # - 352
Self-Ejecting Connector Release	Recept # - 354
Mushroom Pawl	Recept # - 375
Padlock Pawl	Recept # - 843
Padlockable Mushroom Pawl	Recept # - 375-843
Locking Mushroom Pawl	Recept # - 845
Metal Pawl (on poly receptacle)	Recept # - 824
Closed Lid Configuration	Recept # - NC
With Auxiliary Switch	Recept # - 270*

Notes: * Not UL/CSA Listed.

Inlet Options

Suffix

With 2 Auxiliary/Pilot Contacts	Inlet # - 972
Type 4X Watertightness	Inlet # - 4X
Self-Ejecting Plug Release	Inlet # - 338
With No Lockout Hole	Inlet # - A155
For Auxiliary Switch*	Inlet # - NNF

Notes: * Order inlet with P+N+G configuration and receptacle with P+G configuration.

208V DS20 Order Example:

To order 2 auxiliary/pilot contacts on an inlet and receptacle add **-972** to the part numbers.

DS20 Poly inlet 2P+G=33-18162-**972**

DS20 Poly receptacle 2P+G=33-14162-**972**

Appropriate accessory part numbers must also be included on the order.



See pgs 211-220 for detailed information on these options

Installation Accessories

Handles



NPT	Poly Handle	Cable Range	Nylon Handle	Poly Handle w/Clamp & Bushing
1/2"	1PH12	.20 - .82	FH111	-
3/4"	1PH34	.32 - .88	-	-
1"	1PH1	.750 - .875	-	1PM514
1 1/4"	1PH114	.875 - 1.000	-	1PM516
		1.000 - 1.125	-	1PM518
		1.125 - 1.250	-	1PM520
		1.250 - 1.375	-	1PM522

- Notes:**
- Finger draw plates are recommended for easier connector closure on cord to cord assemblies.
 - For available cord grips, see pgs 169-170.

Angles



Nylon 30° Angle	Metal 30° Angle	Metal Angle FS/FD Box 30°	Metal Straight Adapter
MP2	MA2	MAFS2*	MS2

* MAFS2 base measures approximately 4.2" x 2.7". Due to the variation in sizes of FS boxes, please verify that your FS box matches our dimensions, if not call Customer Service for other solutions.

NPT Guidelines

Cable Range	NPT	Cable Range	NPT
.312 - .625	1/2"	.890 - 1.812	1 1/2"
.438 - .812	3/4"	1.190 - 2.438	2"
.660 - 1.000	1"	2.062 - 2.438	2 1/2"
.875 - 1.375	1 1/4"		

NPT sizes are determined by the cable diameter and third party cord grip.

Junction Boxes



NPT	Metal Box	Metal Box with Nylon Angle	Poly* Conduit Entry	Poly 70°** Wall Box	Poly 70° Alum Wall Box
1/2"	MB312	31-1A053-080-12	MC212	51-BA058	59-BA058-12
3/4"	MB334	31-1A053-080-34	MC234	51-BA058	59-BA058-34
1"	MB31	31-1A053-080-1	-	51-BA058	59-BA058-1
1 1/4"	MB3114	31-1A053-080-114	-	51-BA058	59-BA058-114
1 1/2"	-	-	-	-	59-BA058-112

- * For poly devices only. ** 70° poly boxes are not drilled. Contact customer service if factory drilling is required.
 + Interior volume with receptacle installed.

Miscellaneous Accessories



Finger Drawplates	Protective** Cap	Padlockable Plug Cap Poly	Inlet Spring-Loaded Cap	Easy Retrofit Adapter Plates	Receptacle+ Locking Pin
FDP2	31-1A426	DS1PC	31-1A226	see pg 166	LP-843

- * Recommended for cord to cord assembly applications, for easier connector closure. + Requires Padlockable Pawl option (-843) on receptacle.
 ** For watertight seal, the male inlet must also be ordered with the 'No Lockout Hole' option (-A155).

Order Example

A typical order should include an inlet part number, a receptacle part number **AND** the matching handles, angles or other required accessories.



Male Inlet with Handle (Plug)
33-18075 + FH111



Female Receptacle with Angle Adapter
33-14075 + MP2

DS30



DS – 30A Switch-Rated Plugs & Receptacles

UL/CSA Ratings

- **Max Amperage & Voltage**
30A, 600 VAC
- **Switch-Rating (AC Only)**
Branch Circuit & Motor Circuit Disconnect Switching
- **Horsepower Ratings**

120V	1Ø	1 1/2 hp
240V	1Ø	3 hp
208V	3Ø	5 hp
240V	3Ø	5 hp
480V	3Ø	15 hp
600V	3Ø	15 hp
- **Short Circuit Rating**
100kA Close & Withstand
Testing was performed with RK1 current limiting fuses sized at 400% of the highest full load motor ampacity associated with the devices hp rating.
- **Environmental Ratings**
Type 3R, IP54/IP55*
* IP54 when the plug & receptacle are mated. IP55 on the receptacle alone when the lid is latched closed.
- **Temperature Range**
Min -40°F/Max 140°F
See pg 234 for temps below -15°F.
- **Wiring Capacity**
Min 14 AWG Max 4 AWG
Aux Contacts - Max 14 AWG
- **Applicable Standards**
UL 2682, CSA 182.1

Receptacle (female)



Don't forget to add installation accessories to your order

Inlet (male)



North American UL/CSA Configurations

Voltage	Polarity	Part # Poly
120V	1P+N+G	33-34165
120/208V	3P+N+G	33-34167
125V	1P+N+G	33-34075
125/250V	2P+N+G	33-34076
208V	2P+G	33-34162
208V	3P+G	33-34163
250V	2P+G	33-34072
250V	3P+G	33-34073
277V	1P+N+G	33-34045
277/480V	3P+N+G	33-34047
347/600V	3P+N+G	33-34147
480V	2P+G	33-34042
480V	3P+G	33-34043
600V	2P+G	33-34142
600V	3P+G	33-34143

Voltage	Polarity	Part # Poly
120V	1P+N+G	33-38165
120/208V	3P+N+G	33-38167
125V	1P+N+G	33-38075
125/250V	2P+N+G	33-38076
208V	2P+G	33-38162
208V	3P+G	33-38163
250V	2P+G	33-38072
250V	3P+G	33-38073
277V	1P+N+G	33-38045
277/480V	3P+N+G	33-38047
347/600V	3P+N+G	33-38147
480V	2P+G	33-38042
480V	3P+G	33-38043
600V	2P+G	33-38142
600V	3P+G	33-38143

For international configurations and ratings (IEC,CE) visit meltric.com/international-catalog or contact customer service at 800.433.7642.

Main Options



Auxiliary/Pilot Contacts



Mushroom Pawl



Padlock Pawl



Closed Lid Configuration

Recommended for cord applications to keep lid tucked in to avoid damage.

Receptacle Options

Suffix

With 2 Auxiliary/Pilot Contacts	Recept # - 972
With 3 Auxiliary/Pilot Contacts	Recept # - 973
With 4 Auxiliary/Pilot Contacts	Recept # - 974
Type 4X & closed lid configuration	Recept # - 4X
Straight Insertion	Recept # - 352
Self-Ejecting Connector Release	Recept # - 354
Mushroom Pawl	Recept # - 375
Padlock Pawl	Recept # - 843
Padlockable Mushroom Pawl	Recept # - 375-843
Locking Mushroom Pawl	Recept # - 845
Metal Pawl (on poly receptacle)	Recept # - 824
Closed Lid Configuration	Recept # - NC
With Auxiliary Switch	Recept # - 270*

Inlet Options

Suffix

With 2 Auxiliary/Pilot Contacts	Inlet # - 972
With 3 Auxiliary/Pilot Contacts	Inlet # - 973
With 4 Auxiliary/Pilot Contacts	Inlet # - 974
Type 4X Watertightness	Inlet # - 4X
Self-Ejecting Plug Release	Inlet # - 338
With No Lockout Hole	Inlet # - A155
For Auxiliary Switch*	Inlet # - NNF

Notes: * Order inlet with P+N+G configuration and receptacle with P+G configuration

480V DS30 Order Example:

To order 2 auxiliary contacts on an inlet and receptacle add **-972** to the part numbers.

DS30 Poly inlet 3P+G=33-38043-**972**

DS30 Poly receptacle 3P+G=33-34043-**972**

Appropriate accessory part numbers must also be included on the order.



See pgs 211-220 for detailed information on these options

Notes: * Not UL/CSA Listed

Installation Accessories

Handles



Makes connector closures easier

NPT	Poly Handle	Cable Range	Nylon Handle	Poly Handle w/Clamp & Bushing	Poly Handle w/built in Draw Grips
1/2"	3PH12	.38 - 1.12	-	-	-
3/4"	3PH34	.39 - 1.18	FH311	-	FH311-473
1"	3PH1	.750 - .875	-	3PM514	-
1 1/4"	3PH114	.875 - 1.000	-	3PM516	-
		1.000 - 1.125	-	3PM518	-
		1.125 - 1.250	-	3PM520	-
		1.250 - 1.375	-	3PM522	-

- Notes:**
- Finger draw plates are recommended for easier connector closure on cord to cord assemblies.
 - For available cord grips, see pgs 169-170.

Angles



Nylon 30° Angle	Metal 30° Angle	Metal 70° Angle	Metal Angle FS/FD Box 30°	Metal Straight Adapter
MP3	MA3	89-3A027	MAFS3*	MS3

* MAFS3 base measures approximately 4.2" x 2.7". Due to the variation in sizes of FS boxes, please verify that your FS box matches our dimensions, if not call Customer Service for other solutions.

NPT Guidelines

Cable Range	NPT	Cable Range	NPT
.312 - .625	1/2"	.890 - 1.812	1 1/2"
.438 - .812	3/4"	1.190 - 2.438	2"
.660 - 1.000	1"	2.062 - 2.438	2 1/2"
.875 - 1.375	1 1/4"		

NPT sizes are determined by the cable diameter and third party cord grip.

Junction Boxes

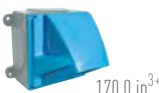

NPT	Metal Box	Metal Box with Nylon Angle	Poly* Conduit Entry	Poly 70° Wall Box	Poly 70° Alum Wall Box
1/2"	MB312	31-3A053-080-12	MC312	51-CA058	59-CA058-12
3/4"	MB334	31-3A053-080-34	MC334	51-CA058	59-CA058-34
1"	MB31	31-3A053-080-1	MC31	51-CA058	59-CA058-1
1 1/4"	MB3114	31-3A053-080-114	-	51-CA058	59-CA058-114
1 1/2"	-	-	-	-	59-CA058-112

- * For poly devices only. ** 70° poly boxes are not drilled. Contact customer service if factory drilling is required.
 + Interior volume with receptacle installed.

Miscellaneous Accessories



* Set of Two (2)



For Male Devices Only



For Male Devices Only



Inlet Spring-Loaded Cap



Mount to existing boxes



Receptacle+ Locking Pin

Finger Drawplates	Protective** Cap	Padlockable Plug Cap Poly	Inlet Spring-Loaded Cap	Easy Retrofit Adapter Plates	Receptacle+ Locking Pin
FDP3	31-3A426	DS3PC	31-3A226	see pg 166	LP-843

- * Recommended for cord to cord assembly applications, for easier connector closure. + Requires Padlockable Pawl option (-843) on receptacle.
 ** For watertight seal, the male inlet must also be ordered with the 'No Lockout Hole' option (-A155).

Order Example

A typical order should include an inlet part number, a receptacle part number **AND** the matching handles, angles or other required accessories.



Male Inlet with Handle (Plug)
33-38043 + FH311



Female Receptacle with Angle Adapter
33-34043 + MP3

DS60



DS – 60A Switch-Rated Plugs & Receptacles

UL/CSA Ratings

- **Max Amperage & Voltage**
60A, 600 VAC
- **Switch-Rating (AC Only)**
Branch Circuit & Motor Circuit Disconnect Switching
- **Horsepower Ratings**

120V	1Ø	2 hp
240V	1Ø	3 hp
208V	3Ø	7 1/2 hp
240V	3Ø	10 hp
480V	3Ø	20 hp
600V	3Ø	25 hp
- **Short Circuit Rating**
100kA Close & Withstand
Testing was performed with RK1 current limiting fuses sized at 400% of the highest full load motor ampacity associated with the devices hp rating.
- **Environmental Ratings**
Type 3R, IP54/IP55*
* IP54 when the plug & receptacle are mated. IP55 on the receptacle alone when the lid is latched closed.
- **Temperature Range**
Min -40°F/Max 140°F
See pg 234 for temps below -15°F.
- **Wiring Capacity**
Min 10 AWG Max 2 AWG
Aux Contacts - Max 14 AWG
- **Applicable Standards**
UL 2682, CSA 182.1

Receptacle (female)



Don't forget to add installation accessories to your order

Inlet (male)



North American UL/CSA Configurations

Voltage	Polarity	Part #	
		Poly	Metal
120V	1P+N+G	33-64165	37-64165
120/208V	3P+N+G	33-64167	37-64167
125V	1P+N+G	33-64075	37-64075
125/250V	2P+N+G	33-64076	37-64076
208V	2P+G	33-64162	37-64162
208V	3P+G	33-64163	37-64163
250V	2P+G	33-64072	37-64072
250V	3P+G	33-64073	37-64073
277V	1P+N+G	33-64045	37-64045
277/480V	3P+N+G	33-64047	37-64047
347/600V	3P+N+G	33-64147	37-64147
480V	2P+G	33-64042	37-64042
480V	3P+G	33-64043	37-64043
600V	2P+G	33-64142	37-64142
600V	3P+G	33-64143	37-64143

Voltage	Polarity	Part #	
		Poly	Metal
120V	1P+N+G	33-68165	37-68165
120/208V	3P+N+G	33-68167	37-68167
125V	1P+N+G	33-68075	37-68075
125/250V	2P+N+G	33-68076	37-68076
208V	2P+G	33-68162	37-68162
208V	3P+G	33-68163	37-68163
250V	2P+G	33-68072	37-68072
250V	3P+G	33-68073	37-68073
277V	1P+N+G	33-68045	37-68045
277/480V	3P+N+G	33-68047	37-68047
347/600V	3P+N+G	33-68147	37-68147
480V	2P+G	33-68042	37-68042
480V	3P+G	33-68043	37-68043
600V	2P+G	33-68142	37-68142
600V	3P+G	33-68143	37-68143

For international configurations and ratings (IEC, CE) visit meltric.com/international-catalog or contact customer service at 800.433.7642.

Main Options



Auxiliary/Pilot Contacts



Mushroom Pawl



Padlock Pawl



Closed Lid Configuration

Recommended for cord applications to keep lid tucked in to avoid damage.

Receptacle Options

Suffix

With 2 Auxiliary/Pilot Contacts	Recept # - 972
With 3 Auxiliary/Pilot Contacts	Recept # - 263*
Type 4X & closed lid configuration	Recept # - 4X
Straight Insertion	Recept # - 352
Self-Ejecting Connector Release	Recept # - 354
Mushroom Pawl	Recept # - 375
Padlock Pawl	Recept # - 843
Padlockable Mushroom Pawl	Recept # - 375-843
Locking Mushroom Pawl	Recept # - 845
Metal Pawl (on poly receptacle)	Recept # - 824
Closed Lid Configuration	Recept # - NC
With Auxiliary Switch	Recept # - 270**

Inlet Options

Suffix

With 2 Auxiliary/Pilot Contacts	Inlet # - 972
With 3 Auxiliary/Pilot Contacts	Inlet # - 263*
Type 4X Watertightness	Inlet # - 4X
Self-Ejecting Plug Release	Inlet # - 338
With No Lockout Hole	Inlet # - A155
For Auxiliary Switch*	Inlet # - NNF

Notes: * Order inlet with P+N+G configuration and receptacle with P+G configuration.

480V DS60 Order Example:

To order 2 auxiliary/pilot contacts on an inlet and receptacle add **-972** to the part numbers.

DS60 Poly inlet 3P+G=33-68043-**972**

DS60 Poly receptacle 3P+G=33-64043-**972**

Appropriate accessory part numbers must also be included on the order.



See pgs 211-220 for detailed information on these options

Installation Accessories

Unless indicated otherwise, accessories can be used with either poly or metal plugs and receptacles.

Handles



NPT	Poly Handle	Metal* Handle	Cable Range	Nylon Handle	Neoprene Handle	Poly Handle w/Clamp & Bushing	Poly Handle w/built in Draw Grips
1/2"	6PH12	6H12	.50 - 1.25	-	31-611	-	-
3/4"	6PH34	6H34	.51 - 1.38	FH611	-	-	FH611-473
1"	6PH1	6H1	1.250 - 1.375	-	-	6PM622	-
1 1/4"	6PH114	6H114	1.438 - 1.562	-	-	6PM625	-
1 1/2"	6PH112	6H112	1.562 - 1.688	-	-	6PM627	-
			1.688 - 1.812	-	-	6PM629	-

- Notes:**
- For available cord grips, see pgs 169-170.
 - For a guideline of NPT sizes based on cable ranges, see DS30 on pg 42.
 - * For metal devices only.

Angles



Nylon 30° Angle	Metal 30° Angle	Metal 70° Angle	Metal Angle+ Oversized 30°	Metal Straight Adapter	Metal Lateral Angle 30°
MP6	MA6	89-6A027	MA660	MS6	MAB6

* Mounts on oversize box only. Order with MB10 box. See page 48.

Junction Boxes



NPT	Metal Box	Metal Box with Nylon Angle**	Poly* Conduit Entry	Poly 70°** Wall Box	Poly 70° Alum Wall Box
1/2"	-	-	MC612	51-DA058	59-DA058-12
3/4"	-	-	MC634	51-DA058	59-DA058-34
1"	MB61	31-6A053-080-1	MC61	51-DA058	59-DA058-1
1 1/4"	MB6114	31-6A053-080-114	MC6114	51-DA058	59-DA058-114
1 1/2"	MB6112	31-6A053-080-112	-	51-DA058	59-DA058-112
2"	MB62	31-6A053-080-2	-	51-DA058	-

- * For poly devices only. ** 70° poly boxes are not drilled. Contact customer service if factory drilling is required.
 + Interior volume with receptacle installed. ** For metal angle, replace "31" prefix with "39". Volume with metal angle is 59.4in³.

Miscellaneous Accessories



Finger Drawplates	Protective Cap	Padlockable Plug Cap Poly	Padlockable Cap Aluminum	Inlet Spring-Loaded cap	Receptacle+ Locking Pin
FDP6	31-6A426	DS6PC	DS6MC	31-6A226	LP-843

- * Recommended for cord to cord assembly applications, for easier connector closure.
 + Requires Padlockable Pawl option (-843) on receptacle.

Accessory Spotlight

Finger Drawplates



Finger drawplates are highly recommended for easier connector closure on cord to cord assemblies.

Order Example

A typical order should include an inlet part number, a receptacle part number **AND** the matching handles, angles or other required accessories.



Male Inlet with Handle (Plug)
33-68043 + FH611



Female Receptacle with Angle Adapter
33-64043 + MP6

DS100C



DS - 100A

Switch-Rated Plugs & Receptacles

UL/CSA Ratings

- **Max Amperage & Voltage**
100A, 600 VAC
- **Switch-Ratings (AC Only)**
Branch Circuit & Motor Circuit
Disconnect Switching
- **Horsepower Ratings**

120V	1Ø	3 hp
240V	1Ø	5 hp
208V	3Ø	10 hp
240V	3Ø	10 hp
480V	3Ø	25 hp
600V	3Ø	25 hp
- **Short Circuit Rating**
100kA Close & Withstand
Testing was performed with RK1
current limiting fuses sized at 400%
of the highest full load motor ampacity
associated with the devices hp rating.
- **Environmental Ratings**
Type 3R, IP54/IP55*
* IP54 when the plug & receptacle are
mated. IP55 on the receptacle alone
when the lid is latched closed.
- **Temperature Range**
Min -40°F/Max 140°F
See pg 234 for temps below -15°F.
- **Wiring Capacity**
Min 10 AWG Max 2 AWG
Aux Contacts - Max 14 AWG
- **Applicable Standards**
UL 2682, CSA 182.1

Receptacle (female)



Don't forget to add installation accessories to your order

Inlet (male)



North American UL/CSA Configurations

Voltage	Polarity	Part #	
		Poly	Metal
120V	1P+N+G	33-64235-C-K16	37-64235-C-K16
120/208V	3P+N+G	33-64237-C-K16	37-64237-C-K16
125V	1P+N+G	33-64175-C-K07	37-64175-C-K07
125/250V	2P+N+G	33-64176-C-K07	37-64176-C-K07
208V	2P+G	33-64232-C-K16	37-64232-C-K16
208V	3P+G	33-64233-C-K16	37-64233-C-K16
250V	2P+G	33-64172-C-K07	37-64172-C-K07
250V	3P+G	33-64173-C-K07	37-64173-C-K07
277V	1P+N+G	33-64245-C-K04	37-64245-C-K04
277/480V	3P+N+G	33-64247-C-K04	37-64247-C-K04
347/600V	3P+N+G	33-64187-C-K14	37-64187-C-K14
480V	2P+G	33-64242-C-K04	37-64242-C-K04
480V	3P+G	33-64243-C-K04	37-64243-C-K04
600V	2P+G	33-64182-C-K14	37-64182-C-K14
600V	3P+G	33-64183-C-K14	37-64183-C-K14

Voltage	Polarity	Part #	
		Poly	Metal
120V	1P+N+G	33-68235-C-K16	37-68235-C-K16
120/208V	3P+N+G	33-68237-C-K16	37-68237-C-K16
125V	1P+N+G	33-68175-C-K07	37-68175-C-K07
125/250V	2P+N+G	33-68176-C-K07	37-68176-C-K07
208V	2P+G	33-68232-C-K16	37-68232-C-K16
208V	3P+G	33-68233-C-K16	37-68233-C-K16
250V	2P+G	33-68172-C-K07	37-68172-C-K07
250V	3P+G	33-68173-C-K07	37-68173-C-K07
277V	1P+N+G	33-68245-C-K04	37-68245-C-K04
277/480V	3P+N+G	33-68247-C-K04	37-68247-C-K04
347/600V	3P+N+G	33-68187-C-K14	37-68187-C-K14
480V	2P+G	33-68242-C-K04	37-68242-C-K04
480V	3P+G	33-68243-C-K04	37-68243-C-K04
600V	2P+G	33-68182-C-K14	37-68182-C-K14
600V	3P+G	33-68183-C-K14	37-68183-C-K14

For international configurations and ratings (IEC,CE) visit meltric.com/international-catalog or contact customer service at 800.433.7642.

Main Options

- Auxiliary/Pilot Contacts
- Mushroom Pawl
- Padlock Pawl
- Closed Lid Configuration
Recommended for cord applications to keep lid tucked in to avoid damage.

Receptacle Options

Receptacle Options	Suffix #
With 2 Auxiliary/Pilot Contacts	Recept # - 972
With 3 Auxiliary/Pilot Contacts	Recept # - 263*
Type 4X & closed lid configuration	Recept # - 4X
Straight Insertion	Recept # - 352
Self-Ejecting Connector Release	Recept # - 354
Mushroom Pawl	Recept # - 375
Padlock Pawl	Recept # - 843
Padlockable Mushroom Pawl	Recept # -375-843
Locking Mushroom Pawl	Recept # - 845
Metal Pawl (on poly receptacle)	Recept # - 824
Closed Lid Configuration	Recept # - NC
With Auxiliary Switch	Recept # - 270**
Recess Plate	Recept # - 142

Inlet Options

Inlet Options	Suffix #
With 2 Auxiliary/Pilot Contacts	Inlet # - 972
With 3 Auxiliary/Pilot Contacts	Inlet # - 263*
Type 4X Watertightness	Inlet # - 4X
Self-Ejecting Plug Release	Inlet # - 338
With No Lockout Hole	Inlet # - A155
For Auxiliary Switch*	Inlet # - NNF

Notes: * Order inlet with P+N+G configuration and receptacle with P+G configuration.

480V DS100C Order Example:

To order 2 auxiliary/pilot contacts on an inlet and receptacle add **-972** to the part numbers.
 DS100C Poly inlet 3P+G=33-68243-C-K04-**972**
 DS100C Poly receptacle 3P+G=33-64243-C-K04-**972**
 Appropriate accessory part numbers must also be included on the order.

Notes: * Not available for metal devices, not UL/CSA listed.
 ** Not UL/CSA listed.

See pgs 211-220 for detailed information on these options

Installation Accessories

Unless indicated otherwise, accessories can be used with either poly or metal plugs and receptacles.

Handles



Not Type 3R

Makes connector closures easier

NPT	Poly Handle	Metal* Handle	Cable Range	Nylon Handle	Neoprene Handle	Poly Handle w/Clamp & Bushing	Poly Handle w/built in Draw Grips
1/2"	6PH12	6H12	.50 - 1.25	-	31-611	-	-
3/4"	6PH34	6H34	.51 - 1.38	FH611	-	-	FH611-473
1"	6PH1	6H1	1.250 - 1.375	-	-	6PM622	-
1 1/4"	6PH114	6H114	1.438 - 1.562	-	-	6PM625	-
1 1/2"	6PH112	6H112	1.562 - 1.688	-	-	6PM627	-
			1.688 - 1.812	-	-	6PM629	-

- Notes:**
- Finger draw plates are recommended for easier connector closure on cord to cord assemblies.
 - For available cord grips, see pgs 169-170.
 - * For metal devices only.
 - For a guideline of NPT sizes based on cable ranges, see DS30 on pg 42.

Angles



Nylon 30° Angle	Metal 30° Angle	Metal 70° Angle	Metal Angle+ Oversized 30°	Metal Straight Adapter	Metal Lateral Angle 30°
MP6	MA6	89-6A027	MA660	MS6	MAB6

* Mounts on oversize box only. Order with MB10xxx box. See page 48.

Junction Boxes

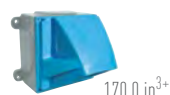

NPT	Metal Box	Metal Box with Nylon Angle**	Poly* Conduit Entry	Poly 70*** Wall Box	Poly 70° Alum Wall Box
1/2"	-	-	MC612	51-DA058	59-DA058-12
3/4"	-	-	MC634	51-DA058	59-DA058-34
1"	MB61	31-6A053-080-1	MC61	51-DA058	59-DA058-1
1 1/4"	MB6114	31-6A053-080-114	MC6114	51-DA058	59-DA058-114
1 1/2"	MB6112	31-6A053-080-112	-	51-DA058	59-DA058-112
2"	MB62	31-6A053-080-2	-	51-DA058	-

- * For poly devices only. ** 70° poly boxes are not drilled. Contact customer service if factory drilling is required.
 + Interior volume with receptacle installed. ** For metal angle, replace "31" prefix with "39". Volume with metal angle is 59.4in³.

Miscellaneous Accessories



Finger Drawplates	Protective Cap	Padlockable Cap	Inlet Spring-Loaded cap	Easy Retrofit Adapter Plates	Receptacle+ Locking Pin
FDP6	31-6A426	DS6MC	31-6A226	see pg 166	LP-843

- * Recommended for cord to cord assembly applications, for easier connector closure.
 + Requires Padlockable Pawl option (-843) on receptacle.

Accessory Spotlight

Receptacle Locking Pin



A 5/16" locking pin can be ordered to securely lockout receptacles that include the 'padlockable pawl' option. The user can also utilize a lock with a 5/16" shank. Locks with smaller shanks will NOT securely lockout a receptacle pawl.

Order Example

A typical order should include an inlet part number, a receptacle part number AND the matching handles, angles or other required accessories.



Male Inlet with Handle (Plug)
33-68243-C-K04 + FH611



Female Receptacle with Angle Adapter
33-64243-C-K04 + MP6

DS100



DS - 100A Switch-Rated Plugs & Receptacles

UL/CSA Ratings

- **Max Amperage & Voltage**
100A, 600 VAC
- **Switch-Rating (AC Only)**
Branch Circuit & Motor Circuit Disconnect Switching
- **Horsepower Ratings**
 - 120V 1Ø 3 hp
 - 240V 1Ø 7 1/2 hp
 - 208V 3Ø 10 hp
 - 240V 3Ø 10 hp
 - 480V 3Ø 30 hp
- **Short Circuit Rating**
65kA Close & Withstand
Testing was performed with RK5 time delay fuses sized at 100% of the devices rated ampacity. Alternate testing was performed with 175A RK1 non-time delay Mersen fuses.
- **Environmental Ratings**
Type 4X, IP66+IP67 (Poly Only)
Type 3R, IP54/IP55* (Metal Only)
* IP54 when the plug & receptacle are mated. IP55 on the receptacle alone when the lid is latched closed.
- **Temperature Range**
Min -40°F/Max 140°F
See pg 234 for temps below -15°F.
- **Wiring Capacity**
Min 4 AWG Max 2/0 AWG
Aux Contacts - Max 14 AWG
- **Applicable Standards**
UL 2682, CSA 182.1

Receptacle (female)

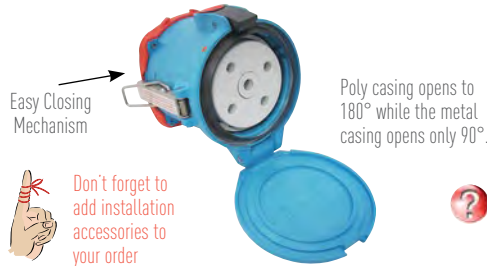

Inlet (male)

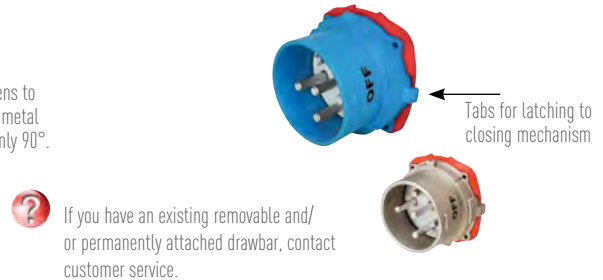

North American UL/CSA Configurations

Voltage	Polarity	Part #	
		Poly	Metal
120V	1P+N+G	33-94165	37-94165
120/208V	3P+N+G*	33-94167	37-94167
125V	1P+N+G	33-94075	37-94075
125/250V	2P+N+G	33-94076	37-94076
208V	2P+G	33-94162	37-94162
208V	3P+G	33-94163	37-94163
250V	2P+G	33-94072	37-94072
250V	3P+G	33-94073	37-94073
277V	1P+N+G	33-94045	37-94045
277/480V	3P+N+G	33-94047	37-94047
347/600V	3P+N+G	33-94147	37-94147
480V	2P+G	33-94042	37-94042
480V	3P+G	33-94043	37-94043
600V	2P+G	33-94142	37-94142
600V	3P+G	33-94143	37-94143

Voltage	Polarity	Part #	
		Poly	Metal
120V	1P+N+G	33-98165	37-98165
120/208V	3P+N+G*	33-98167	37-98167
125V	1P+N+G	33-98075	37-98075
125/250V	2P+N+G	33-98076	37-98076
208V	2P+G	33-98162	37-98162
208V	3P+G	33-98163	37-98163
250V	2P+G	33-98072	37-98072
250V	3P+G	33-98073	37-98073
277V	1P+N+G	33-98045	37-98045
277/480V	3P+N+G*	33-98047	37-98047
347/600V	3P+N+G*	33-98147	37-98147
480V	2P+G	33-98042	37-98042
480V	3P+G	33-98043	37-98043
600V	2P+G	33-98142	37-98142
600V	3P+G	33-98143	37-98143

For international configurations and ratings (IEC, CE) visit meltric.com/international-catalog or contact customer service at 800.433.7642.

Main Options



Receptacle Options

Receptacle Options	Suffix #
With 2 Auxiliary/Pilot Contacts	Recept # - 262
With 3 Auxiliary/Pilot Contacts	Recept # - 263
With 4 Auxiliary/Pilot Contacts	Recept # - 264
With 5 Auxiliary/Pilot Contacts	Recept # - 975
With 6 Auxiliary/Pilot Contacts	Recept # - 976
Type 4X & closed lid configuration	Recept # - 4X ⁱ
Straight Insertion	Recept # - 352
Self-Ejecting Connector Release	Recept # - 354
Mushroom Pawl	Recept # - 375
Padlock Pawl	Recept # - 843
Padlockable Mushroom Pawl	Recept # - 375-843
Locking Mushroom Pawl	Recept # - 845
Metal Pawl (on poly receptacle)	Recept # - 824
180° Opening Lid	Recept # - 180 ⁺⁺
Closed Lid Configuration	Recept # - NC
With Auxiliary Switch	Recept # - 270 ⁺⁺⁺

Inlet Options

Inlet Options	Suffix #
With 2 Auxiliary/Pilot Contacts	Inlet # - 262
With 3 Auxiliary/Pilot Contacts	Inlet # - 263
With 4 Auxiliary/Pilot Contacts	Inlet # - 264
With 5 Auxiliary/Pilot Contacts	Inlet # - 975
With 6 Auxiliary/Pilot Contacts	Inlet # - 976
Type 4X Watertightness	Inlet # - 4X ⁱ
Self-Ejecting Plug Release	Inlet # - 338
With No Lockout Hole	Inlet # - A155
For Auxiliary Switch*	Inlet # - NNF

Notes: * Order inlet with P+N+G configuration and receptacle with P+G configuration.

480V DS100 Order Example:

To order 2 auxiliary/pilot contacts on an inlet and receptacle add **-262** to the part numbers.

DS100 Poly inlet 3P+G=63-98043-**262**

DS100 Poly receptacle 3P+G=63-94043-**262**

Appropriate accessory part numbers must also be included on the order.

See pgs 211-220 for detailed information on these options

Notes: ++ Required when mating to rigid mounted male inlet.

+++ Not UL/CSA listed.

ⁱ Metal devices only.

Installation Accessories

Unless indicated otherwise, accessories can be used with either poly or metal plugs and receptacles.

Handles



NPT	Poly Handle	Metal* Handle	Oversized* Metal Handle
3/4"	9PH34	9H34	9MH34
1"	9PH1	9H1	9MH1
1 1/4"	9PH114	9H114	9MH114
1 1/2"	9PH112	9H112	9MH112
2"	9PH2	9H2	9MH2
2 1/2"	-	-	9MH212

Cable Range	Santoprene™ Handle	Poly Handle w/Clamp & Bushing
.70 - 1.00	65-9A013-D25	-
.984 - 1.377	65-9A013-D35	-
1.250 - 1.375	-	9PM622
1.377 - 1.771	65-9A013-D45	-
1.438 - 1.562	-	9PM625
1.562 - 1.688	-	9PM627
1.688 - 1.812	-	9PM629

- Notes:**
- Finger draw plates are recommended for easier connector closure on cord to cord assemblies.
 - For a guideline of NPT sizes based on cable ranges, see DS30 on pg 42.
 - For available cord grips, see pgs 169-170.
 - * For metal devices only.

Angles



Nylon 30° Angle	Metal 30° Angle	Metal 70° Angle	Metal Angle+ Oversized 30°	Metal Straight Adapter
MP10	MA10	89-9A027	MA110	MS10

+ Mounts on oversize box only. Order with MB2xxx box. See page 50.

Junction Boxes



NPT	Metal Box	Metal Box with Nylon Angle	Metal Box with Metal Angle
1 1/4"	MB10114	31-9A053-080-114	39-9A053-080-114
1 1/2"	MB10112	31-9A053-080-112	39-9A053-080-112
2"	MB102	31-9A053-080-2	39-9A053-080-2
2 1/2"	MB10212	31-9A053-080-212	39-9A053-080-212

+ Interior volume with receptacle installed.

Miscellaneous Accessories



Protective Cap	Padlockable Cap Aluminum	Cord Grip with Mesh	Easy Retrofit Adapter Plates	Receptacle+ Locking Pin
31-9A126	DS9MC	see pgs 169-170	see pg 166	LP-843

+ Requires Padlockable Pawl option (-843) on receptacle.

Order Example

A typical order should include an inlet part number, a receptacle part number **AND** the matching handles, angles or other required accessories.



Male Inlet with Handle (Plug)
37-98043 + 65-9A013-D25



Female Receptacle with Angle Adapter
37-94043 + MA10

Feature Spotlight – Easy Closing Mechanism

A new and simplified closing mechanism is now standard on the DS100 and DS200 plugs and receptacles. This compact mechanism enables easy connection of the plug to the receptacle.

Notes: After connection, the mechanism must be released to allow disconnection of the device.

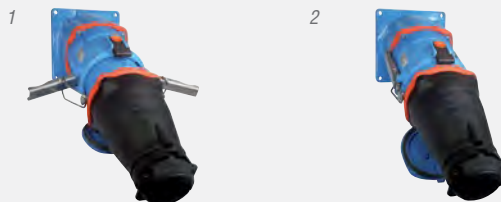

The plug is partially inserted, clamps are placed around tab, ready to pull the plug into the receptacle.

The handles are pushed down, the plug is fully drawn into the receptacle.

DS200



DS – 200A Switch-Rated Plugs & Receptacles

UL/CSA Ratings

- **Max Amperage & Voltage**
200A, 480 VAC
- **Switch-Rating (AC Only)**
Branch Circuit
Disconnect Switching
- **Short Circuit Rating**
65kA Close & Withstand
Testing was performed with RK5 time delay fuses sized at 100% of the devices rated ampacity.
- **Environmental Ratings**
Type 3R, IP54/IP55*
* IP54 when the plug & receptacle are mated. IP55 on the receptacle alone when the lid is latched closed.
- **Temperature Range**
Min -40°F/Max 140°F
See pg 234 for temps below -15°F.
- **Wiring Capacity**
Min 4 AWG Max 3/0 AWG
Aux Contacts - Max 14 AWG
* 4/0 is available upon request by adding suffix "A06" to the inlet or receptacle.
- **Applicable Standards**
UL 2682, CSA 182.1

* See DR250 for 600V device page 103.

Receptacle (female)



Inlet (male)



North American UL/CSA Configurations

Voltage	Polarity	Part # Metal
120V	1P+N+G	37-24165
120/208V	3P+N+G	37-24167
125V	1P+N+G	37-24075
125/250V	2P+N+G	37-24076
208V	2P+G	37-24162
208V	3P+G	37-24163
250V	2P+G	37-24072
250V	3P+G	37-24073
277V	1P+N+G	37-24045
277/480V	3P+N+G	37-24047
347/600V	3P+N+G	*
480V	2P+G	37-24042
480V	3P+G	37-24043
600V	2P+G	*
600V	3P+G	*

Voltage	Polarity	Part # Metal
120V	1P+N+G	37-28165
120/208V	3P+N+G	37-28167
125V	1P+N+G	37-28075
125/250V	2P+N+G	37-28076
208V	2P+G	37-28162
208V	3P+G	37-28163
250V	2P+G	37-28072
250V	3P+G	37-28073
277V	1P+N+G	37-28045
277/480V	3P+N+G	37-28047
347/600V	3P+N+G	*
480V	2P+G	37-28042
480V	3P+G	37-28043
600V	2P+G	*
600V	3P+G	*

For international configurations and ratings (IEC,CE) visit meltric.com/international-catalog or contact customer service at 800.433.7642.

Main Options



? See pgs 211-220 for detailed information on these options

Receptacle Options

Receptacle Options	Suffix #
With 2 Auxiliary/Pilot Contacts	Recept # - 172
With 3 Auxiliary/Pilot Contacts	Recept # - 173*
With 4 Auxiliary/Pilot Contacts	Recept # - 174*
With 5 Auxiliary/Pilot Contacts	Recept # - 175*
Type 4X & closed lid configuration	Recept # - 4X
Self-Ejecting Connector Release	Recept # - 348-A188
Mushroom Pawl	Recept # - 375
Padlock Pawl	Recept # - 843
Padlockable Mushroom Pawl	Recept # - 375-843
Locking Mushroom Pawl	Recept # - 845
180° Opening Lid	Recept # - 180**
Closed Lid Configuration	Recept # - NC
With Auxiliary Switch	Recept # - 270***

Notes: + DS200 with this option not UL/CSA listed. This option not available with N contact.
++ Required when mating to rigid mounted male inlet.
+++ Not UL/CSA listed.

Inlet Options

Inlet Options	Suffix #
With 2 Auxiliary/Pilot Contacts	Inlet # - 172
With 3 Auxiliary/Pilot Contacts	Inlet # - 173*
With 4 Auxiliary/Pilot Contacts	Inlet # - 174*
With 5 Auxiliary/Pilot Contacts	Inlet # - 175*
Type 4X Watertightness	Inlet # - 4X
Self-Ejecting Plug Release	Inlet # - 338-A188
Straight Insertion	Inlet # - A188
With No Lockout Hole	Inlet # - A155
For Auxiliary Switch*	Inlet # - NNF

Notes: * Order inlet with P+N+G configuration and receptacle with P+G configuration.

480V DS200 Order Example:

To order 2 auxiliary contacts on an inlet and receptacle add **-172** to the part numbers.

DS200 Metal inlet 3P+G=37-28043-**172**

DS200 Metal receptacle 3P+G=37-24043-**172**

Appropriate accessory part numbers must also be included on the order.

Installation Accessories

Handles



IP 66/67

NPT	Poly Handle	Metal* Handle
1"	-	2H1
1 1/4"	-	2H114
1 1/2"	2PH112	2H112
2"	2PH2	2H2
2 1/2"	2PH212	2H212
3"	-	2H3

Cable Range	Santoprene™ Handle
.984 - 1.377	35-2A013-D35
1.377 - 1.771	35-2A013-D45
1.771 - 1.929	35-2A013-D49

NPT Guidelines

Cable Range	NPT
.312 - .625	1/2"
.438 - .812	3/4"
.660 - 1.000	1"
.875 - 1.375	1 1/4"
.890 - 1.812	1 1/2"
1.190 - 2.438	2"
2.062 - 2.438	2 1/2"
2.438 - 2.812	3"

NPT sizes are determined by the cable diameter and third party cord grip.

Notes: • For available cord grips, see pgs 169-170.

Angles



Metal 60° Angle	Metal Angle+ Oversized 45°	Metal Straight Adapter
MA20	MA220	MS20

+ Mounts on oversize box only.

Junction Boxes



NPT	Metal Box	Metal Box Oversized	Metal Box with Metal Angle
1 1/2"	MB20112	-	39-2A053-080-112
2"	MB202	-	39-2A053-080-2
2 1/2"	MB20212	MB22212	39-2A053-080-212

+ Interior volume with receptacle installed.

Accessory Spotlight

Receptacle Locking Pin



A 5/16" locking pin can be ordered to securely lockout receptacles that include the 'padlockable pawl' option. The user can also utilize a lock with a 5/16" shank. Locks with smaller shanks will NOT securely lockout a receptacle pawl.

Miscellaneous Accessories



For Male Devices Only



For Male Devices Only



Mount to existing boxes



Receptacle Locking Pin

Protective Cap	Padlockable Cap Aluminum	Easy Retrofit Adapter Plates	Receptacle+ Locking Pin
35-2A126	DS2MC	see pg 166	LP-843

+ Requires Padlockable Pawl option (-843) on receptacle.

Feature Spotlight – Easy Closing Mechanism

A new and simplified closing mechanism is now standard on the DS100 and DS200 plugs and receptacles. This compact mechanism enables easy connection of the plug to the receptacle.

Notes: After connection, the mechanism must be released to allow disconnection of the device.



The plug is partially inserted, clamps are placed around tab, ready to pull the plug into the receptacle.



The handles are pushed down, the plug is fully drawn into the receptacle.

Order Example

A typical order should include an inlet part number, a receptacle part number **AND** the matching handles, angles or other required accessories.



Male Inlet with Handle (Plug)
37-28043 + 35-2A013-D35







Female Receptacle with Angle Adapter
37-24043 + MA20

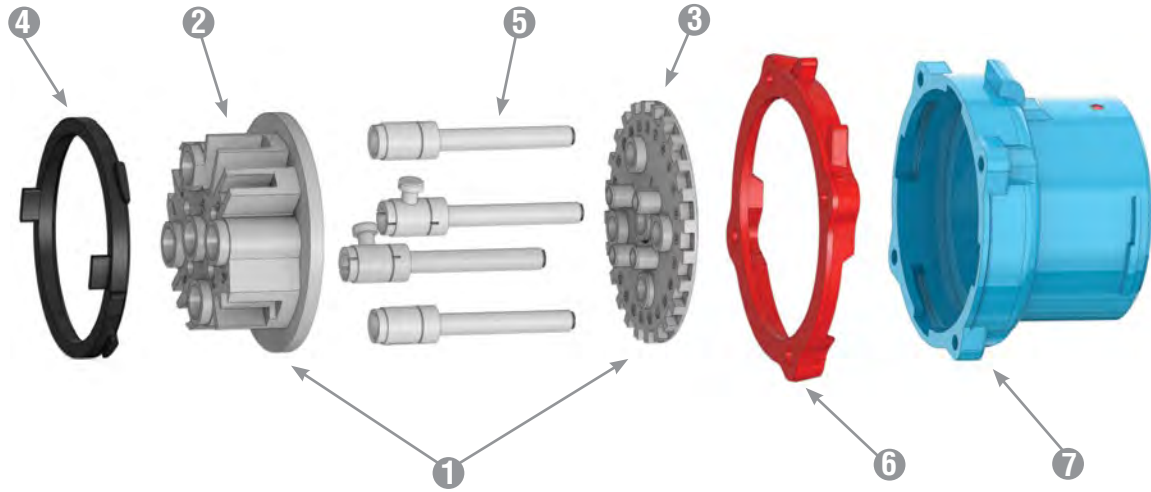

Spare Parts Male Configuration



	DS20 POLY	DS30 POLY	DS60 POLY	DS60 METAL	DS100C POLY	DS100C METAL	DS100 POLY	DS100 METAL	DS200 METAL
1 = Plug Interior***	31-1A010*	31-3A010*	31-6A010*	31-6A010*	31-6A010-C*	31-6A010-C*	61-9A010*	69-9A010*	39-2A010*
1 = Plug Interior w/Ground Contacts***	-	-	-	39-6A110*	-	39-6A110-C*	-	69-9A110*	39-2A110*
1 = Plug Interior with 2 Pilots ⁺	31-1A310-972*	31-3A310-972*	31-6A310-972*	31-6A310-972*	31-6A310-C-972*	31-6A310-C-972*	61-9A310-262*	61-9A310-262*	39-2A310-172*
2 = Interior Bottom***	31-1A010-B	31-3A010-B	31-6A010-B	31-6A010-B	31-6A010-C-B	31-6A010-C-B	61-9A551	69-9A551	39-2A010-B
3 = Interior Top***	31-1A010-T*	31-3A010-T*	31-6A010-T*	31-6A010-T*	31-6A010-C-T*	31-6A010-C-T*	61-9A010-T*	69-9A010-T*	39-2A010-T*
4 = Polyester Locking Ring	31-1A583	31-3A583	31-6A583	-	31-6A583	-	31-9A583	-	-
4 = Metal Locking Ring	-	-	-	39-6A583	-	39-6A583	-	39-9A583	39-2A583
5 = Plug Phase Contact (If no aux. contacts)	31-1A011-380	31-3A011-380	31-6A011	31-6A011	31-6A011-C	31-6A011-C	61-9A011	61-9A011	39-2A011
5 = Plug Phase Contact (If plug has aux. contacts)	31-1A011	31-3A011-380	31-6A011	31-6A011	31-6A011-C	31-6A011-C	61-9A011	61-9A011	39-2A011
5 = Plug Ground Contact	31-1A019	31-3A019	31-6A019	39-6A019	31-6A019-C	39-6A019-C	61-9A019	69-9A019	39-2A019
6 = Color-Coded Voltage Gasket	 31-1AB26	31-3AB26	31-6AB26	31-6AB26	31-6AB26	31-6AB26	31-9AB26	31-9AB26	39-2AB26
	 31-1AC26	31-3AC26	31-6AC26	31-6AC26	31-6AC26	31-6AC26	31-9AC26	31-9AC26	39-2AC26
	 31-1AR26	31-3AR26	31-6AR26	31-6AR26	31-6AR26	31-6AR26	31-9AR26	31-9AR26	39-2AR26
	 31-1AN26	31-3AN26	31-6AN26	31-6AN26	31-6AN26	31-6AN26	31-9AN26	31-9AN26	39-2AN26
	 31-1AC26	31-3AC26	31-6AC26	31-6AC26	31-6AC26	31-6AC26	31-9AC26	31-9AC26	39-2AC26
7 = Plug Polyester Casing	31-1A014**	31-3A014**	31-6A014**	-	31-6A014**	-	61-9A014**	-	-
7 = Plug Metal Casing	-	-	-	39-6A014**	-	39-6A014**	-	39-9A014**	39-2A014**

* Voltage and phasing positions must be specified (5th, 6th & 7th digit of Part #) to duplicate your shutter and alignment notches.

** For appropriate labeling on a device, please specify voltage, phasing, and product type.

*** For interiors with pilot contacts, contact Customer Service for part numbers.

⁺ For interiors with more than 2 pilot contacts, contact Customer Service for part numbers.

Spare Parts Female Configuration

DS

DS

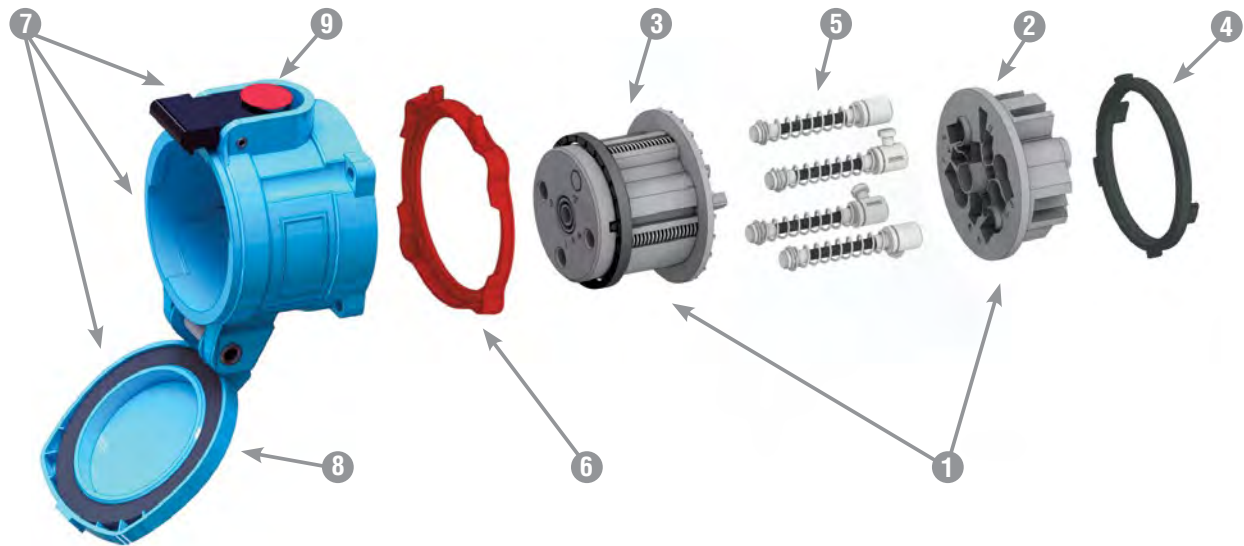

	DS20 POLY	DS30 POLY	DS60 POLY	DS60 METAL	DS100C POLY	DS100C METAL	DS100 POLY	DS100 METAL	DS200 METAL
① = Receptacle Interior***	31-1A020*	31-3A020*	31-6A020*	31-6A020*	31-6A020-C*	31-6A020-C*	61-9A020*	69-9A020*	39-2A020*
① = Recept Interior w/Ground Contacts***	-	-	-	39-6A220*	-	39-6A220-C*	-	69-9A220*	39-2A220*
① = Receptacle Interior with 2 Pilots [†]	31-1A320-972*	31-3A320-972*	31-6A320-972*	31-6A320-972*	31-6A320-C-972*	31-1A320-C-972*	61-9A320-262*	61-9A320-262*	39-2A320-172*
② = Interior Bottom***	31-1A020-B	31-3A020-B	31-6A020-B	31-6A020-B	31-6A020-C-B	31-6A020-C-B	61-9A552	69-9A552	39-2A020-B
③ = Interior Top***	31-1A020-T*	31-3A020-T*	31-6A020-T*	31-6A020-T*	31-6A020-C-T*	31-6A020-C-T*	61-9A020-T*	69-9A020-T*	39-2A020-T*
④ = Polyester Locking Ring	31-1A583	31-3A583	31-6A583	-	31-6A583	-	31-9A583	-	-
④ = Metal Locking Ring	-	-	-	39-6A583	-	39-6A583	-	39-9A583	39-2A583
⑤ = Recept Phase Contact (If no aux. contacts)	31-1A021-380	31-3A021-380	31-6A021	31-6A021	31-6A021-C	31-6A021-C	61-9A021	61-9A021	39-2A021
⑤ = Recept Phase Contact (If plug has aux. contacts)	31-1A021	31-3A021-380	31-6A021	31-6A021	31-6A021-C	31-6A021-C	61-9A021	61-9A021	39-2A021
⑤ = Recept Ground Contact	31-1A029	31-3A029	31-6A029	39-6A029	31-6A029-C	39-6A029-C	61-9A029	69-9A029	39-2A029
⑥ = Color-Coded Voltage Gasket	<div style="display: flex; flex-direction: column; gap: 5px;"> <div>208V 31-1AB26</div> <div>250V 31-1AC26</div> <div>480V 31-1AR26</div> <div>600V 31-1AN26</div> <div>125V 31-1AC26</div> </div>	31-3AB26	31-6AB26	31-6AB26	31-6AB26	31-6AB26	31-9AB26	31-9AB26	39-2AB26
		31-3AC26	31-6AC26	31-6AC26	31-6AC26	31-6AC26	31-9AC26	31-9AC26	39-2AC26
		31-3AR26	31-6AR26	31-6AR26	31-6AR26	31-6AR26	31-9AR26	31-9AR26	39-2AR26
		31-3AN26	31-6AN26	31-6AN26	31-6AN26	31-6AN26	31-9AN26	31-9AN26	39-2AN26
		31-3AC26	31-6AC26	31-6AC26	31-6AC26	31-6AC26	31-9AC26	31-9AC26	39-2AC26
⑦ = Receptacle Polyester Casing with Lid	31-1A024**	31-3A024**	31-6A024**	-	31-6A024**	-	61-9A024**	-	-
⑦ = Receptacle Metal Casing with Lid	-	-	-	39-6A024**	-	39-6A024**	-	39-9A024**	39-2A024**
⑧ = Lid Replacement Kit Polyester	31-1A125	31-3A125	31-6A425	-	31-6A125	-	61-9A125	-	-
⑧ = Lid Replacement Kit Metal	-	-	-	39-6A925	-	39-6A925	-	39-9A925	39-2A925
⑨ = Pawl Replacement Kit Polyester	31-1A824	31-3A824	31-6A824	-	31-6A824	-	61-9A824	-	-
⑨ = Pawl Replacement Kit Metal	39-1A824	39-3A824	39-6A824	39-6A824	39-6A824	39-6A824	69-9A924	39-9A824	39-2A824

* Voltage and phasing positions must be specified (5th, 6th & 7th digit of Part #) to duplicate your shutter and alignment notches.

** For appropriate labeling on a device, please specify voltage, phasing, and product type.

*** For interiors with more than 2 pilot contacts, contact Customer Service for part numbers.

[†] For interiors with more than 2 pilot contacts, contact Customer Service for part numbers.

For replacement parts contact customer service at 800.433.7642

DS



Dimensions

Inlet – Provided in inches

Dimensions are for reference only and may change depending on accessories used. For precise dimensions contact MELTRIC Engineering.

plug

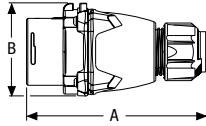

PRODUCT	A	B
DS20/DS24	5.72	2.79
DS30/DS37	6.15	3.23
DS60/DS100C/DS7	6.70	3.77
DS100	8.09	4.79
DS200	10.30	5.67

Inlet with connector

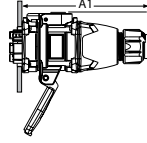

PRODUCT	A1
DS20/DS24	6.67
DS30/DS37	7.05
DS60/DS100C/DS7	8.05
DS100	10.29
DS200	12.44

Inlet

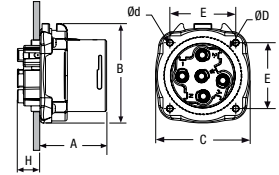

PRODUCT	A	B	C	E	H	Ød	ØD
DS20/DS24	1.86	2.76	2.57	1.89	0.72	0.20	2.07
DS30/DS37	2.07	3.23	3.07	2.17	0.86	0.20	2.48
DS60/DS100C/DS7	2.38	3.77	3.60	2.60	1.04	0.24	3.15
DS100	2.96	4.79	4.50	3.19	1.09	0.24	3.81
DS200	3.20	5.67	5.79	3.86	1.46	0.26	4.57

30° inclined inlet/angle with connector

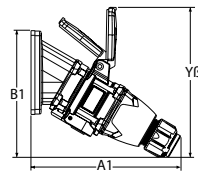

PRODUCT	A1	B1	YB
DS20/DS24	7.50	6.59	7.60
DS30/DS37	8.05	6.89	8.44
DS60/DS100C/DS7	7.90	5.35	9.09
DS100	12.34	10.00	11.34
DS200 60°	11.08	16.81	

30° inlet/angle

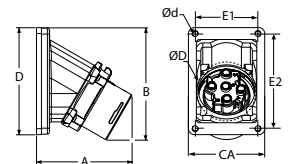

PRODUCT	A	B	CA	D	E1	E2	Ød	ØD
DS20/DS24	3.54	4.56	3.00	4.21	2.48	3.74	0.22	2.25
DS30/DS37	3.93	4.80	3.00	4.21	2.48	3.74	0.22	2.36
DS60/DS100C/DS7	4.42	5.84	4.02	5.35	3.43	4.80	0.26	2.76
DS100	6.11	6.50	5.57	5.57	4.83	4.83	0.28	4.72
DS200 60°	6.90	9.10	7.20	7.20	6.50	6.50	0.25	4.80

30° inclined inlet/angle/ junction box with connector

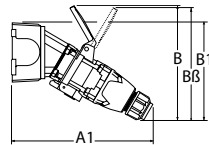

PRODUCT	A1	B	B1	Bβ
DS20/DS24	9.23	7.56	6.74	6.85
DS30/DS37	10.30	7.51	7.02	8.46
DS60/DS100C/DS7	11.87	9.09	8.19	10.00
DS100	16.06	12.24	10.00	
DS200 60°	15.76	16.81	13.66	

inlet/angle/ metal junction box

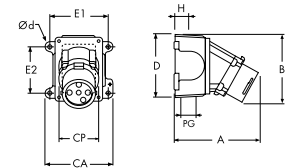

PRODUCT	A	B	CA	CP	D	E1	E2	H	PG	Ød
DS20/DS24	5.89	4.69	4.40	2.48	4.50	4.19	2.75	1.10	1.00	0.27
DS30/DS37	6.26	4.91	4.40	2.48	4.50	4.19	2.75	1.10	1.00	0.27
DS60/DS100C/DS7	7.50	6.00	5.75	3.44	5.84	5.00	3.82	1.50	1.50	0.33
DS100	9.81	6.50	7.50	4.83	5.50	6.75	4.24	1.84	2.00	0.31
DS200 60°	11.60	8.96	9.26	6.50	7.25	8.13	6.38	1.92	2.50	0.31

70° inclined inlet/wall box with connector

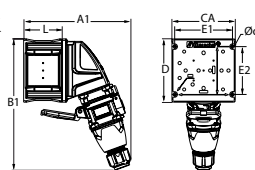

PRODUCT	A1	B1	CA	D	E1	E2	L	Ød
DS20/DS24	8.42	10.50	5.04	5.04	4.57	3.78	3.07	0.26
DS30/DS37	9.53	12.32	6.69	6.69	6.14	5.43	3.07	0.26
DS60/DS100C/DS7	9.84	13.31	6.69	6.69	6.14	5.43	3.07	0.26

70° inlet/wall box

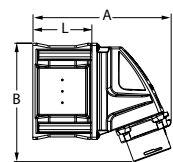

PRODUCT	A	B	L
DS20/DS24	7.17	6.14	3.07
DS30/DS37	8.19	7.70	3.07
DS60/DS100C/DS7	8.31	8.31	3.07



Dimensions

Receptacle – Provided in inches

Dimensions are for reference only and may change depending on accessories used. For precise dimensions contact MELTRIC Engineering.

connector

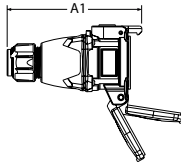

PRODUCT	A1
DS20/DS24	6.38
DS30/DS37	6.93
DS60/DS100C/DS7	7.75
DS100	9.75
DS200	10.87

receptacle with plug

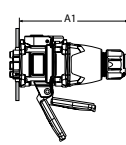

PRODUCT	A1
DS20/DS24	6.67
DS30/DS37	7.05
DS60/DS100C/DS7	8.05
DS100	10.29
DS200	12.06

receptacle

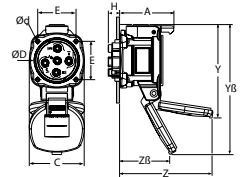

PRODUCT	A	C	E	H	Y	YB	Z	ZB	Ød	ØD
DS20/DS24	2.60	2.61	1.89	0.70	4.14	6.32	4.63	1.93	0.20	2.25
DS30/DS37	2.87	3.04	2.17	0.86	4.48	7.16	4.84	2.33	0.20	2.68
DS60/DS100C/DS7	3.37	3.59	2.60	1.16	6.57	8.46	5.91	2.76	0.22	3.21
DS100	4.60	4.46	3.19	1.09	8.03	10.94	8.70	3.46	0.24	3.81
DS200	4.75	5.16	3.86	1.46	7.99	11.54	8.62	2.48	0.26	4.57

30° inclined receptacle/angle with plug

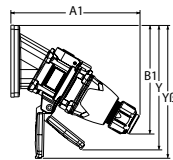

PRODUCT	A1	B1	Y	YB
DS20/DS24	7.50	6.59	6.86	7.87
DS30/DS37	8.05	6.89	8.87	8.44
DS60/DS100C/DS7	7.90	8.07	10.00	10.16
DS100	12.34	10.00	12.05	12.05
DS200 60°	11.08	16.67	15.03	

30° receptacle/angle

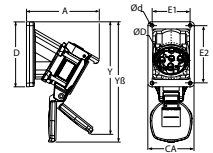

PRODUCT	A	D	E1	E2	Y	YB	Ød	ØD
DS20/DS24	4.51	4.25	2.48	3.74	6.84	7.87	0.22	2.25
DS30/DS37	4.91	4.25	2.48	3.74	8.79	8.43	0.22	2.25
DS60/DS100C/DS7	5.62	5.35	3.43	4.80	9.11	10.32	0.26	2.76
DS100	7.89	5.57	4.83	4.83	12.05	12.05	0.28	4.72
DS200 60°	8.43	7.20	6.50	6.50	15.08		0.25	4.80

30° inclined receptacle/angle/ junction box with plug

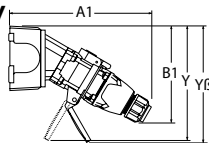

PRODUCT	A1	B1	Y	YB
DS20/DS24	9.84	6.73	7.29	7.94
DS30/DS37	10.30	7.02	8.39	8.39
DS60/DS100C/DS7	11.87	8.19	10.45	9.24
DS100	16.06	9.53	11.77	
DS200 60°	15.76	13.66	11.54	

receptacle/angle/ metal junction box

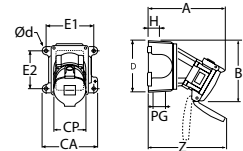

PRODUCT	A	B	CA	CP	D	E1	E2	H	PG	Z	Ød
DS20/DS24	6.86	5.37	4.40	2.61	4.50	4.19	2.75	1.10	1.00	6.77	0.27
DS30/DS37	7.25	5.62	4.40	2.70	4.50	4.19	2.75	1.10	1.00	6.77	0.27
DS60/DS100C/DS7	8.75	7.00	5.75	3.44	5.84	5.00	3.82	1.50	1.50	7.56	0.33
DS100	11.50	7.80	7.50	4.83	5.50	6.75	4.24	1.84	2.00	10.28	0.33
DS200 60°	13.11	9.77	9.25	6.50	7.25	8.13	6.38	1.92	2.50	11.89	0.33

70° receptacle/wall box

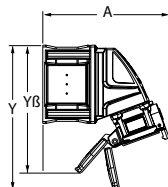

PRODUCT	A	Y	YB
DS20/DS24	8.03	9.25	9.24
DS30/DS37	9.06	9.57	11.30
DS60/DS100C/DS7	9.33	12.56	10.59

70° inclined receptacle/ wall box with plug

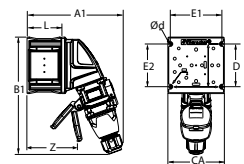

PRODUCT	A1	B1	CA	D	E1	E2	L	Z	Ød
DS20/DS24	8.41	10.50	5.00	5.00	4.57	3.78	3.07	4.91	0.26
DS30/DS37	9.53	12.32	6.69	6.69	6.14	5.43	3.07	4.91	0.26
DS60/DS100C/DS7	9.76	13.03	6.69	6.69	6.22	5.47	3.07	4.09	0.26



DB



Features and Ratings	p. 56
DB30	p. 59
DB60	p. 61
DB100	p. 63
Spare parts	p. 65
Dimensions	p. 67



Switch-rated plugs and receptacles

DB's are the most rugged and highest horsepower rated plugs and receptacles in the Switch-Rated product family. They are specifically designed for use on motors and other inductive loads. With their unique internal spring operating mechanism, two stage contact system, arc splitting feature and silver-nickel butt contacts, DB's can easily handle high horsepower inductive loads up to 60 hp.

Main Advantages

- ▶ Switch & Hp rated
- ▶ 100 kA short circuit rated*
- ▶ IP67 environmental ratings
- ▶ Up to 4 auxiliary contacts
- ▶ Durable metal construction.

Highlighted Advantage

Simplify Compliance to
NFPA 70E & CSA Z462

See pgs 19-20 for
more information



Product Features

DECONTACTOR™ Technology

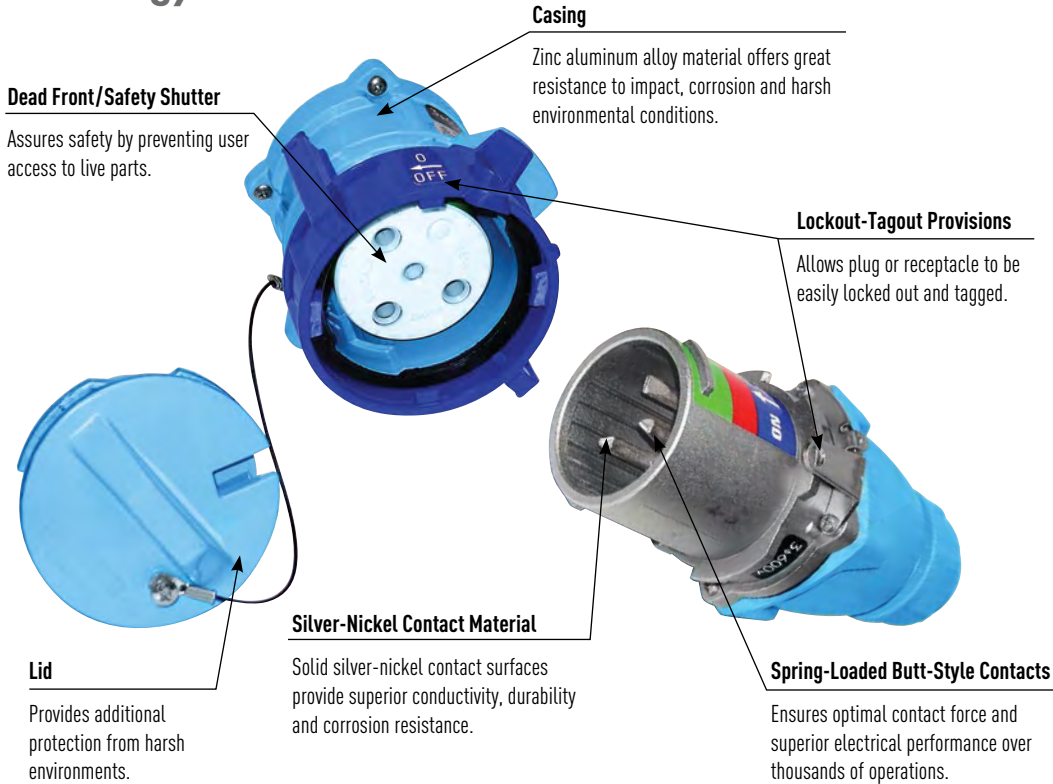

General Ratings

Amperage	30 to 100A
Voltage	600 VAC
Frequency	50-400 Hz
Horsepower	2 to 60 hp
Short-Circuit (Make & Withstand)	100kA*
Environmental	IP67
Temperature	min -40°F/max 140°F

* Testing was performed with RK1 current limiting fuses sized at 400% of the highest full load motor ampacity associated with the devices horsepower ratings, except for the DB100, which was tested with 250A fuses.

Highlighted Feature

Typical Device Labels

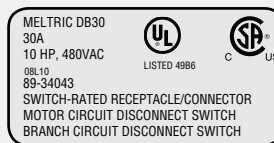

Meltric DB Series Switch-Rated devices are UL & CSA rated for "motor circuit" and "branch circuit" disconnect switching – up to 60 hp and up to 100A.

Listings

Category	UL	CSA	IEC
Plugs and Receptacles	UL 1682	C22.2 No. 182.1	60309-1
Branch Circuit Disconnect Switching	UL Subject 2682 (Performance tested to UL 98)	C22.2 No. 4	60947-3, AC22, AC23
Motor Circuit Disconnect Switching	UL Subject 2682 (Performance tested to UL 508)	C22.2 No. 14	

CE ratings available upon request.

Operating Instructions



When the plug and receptacle are latched together, the circuit is connected.



Turning the receptacle ring counterclockwise releases the plug and rapidly opens the circuit. The plug is ejected to its rest position.



From the rest position the 'dead' plug can be withdrawn by rotating it counterclockwise. The receptacle can be made watertight up to IP67 by replacing the lid and turning the locking ring fully clockwise.



To reconnect, insert plug and twist. Pushing the plug fully home safely makes the circuit. The plug is held in the 'on' position by a locking ring. IP67 protection is enabled by fully rotating the locking ring in the clockwise direction.

Product Features

Spring-Loaded Operating Mechanism

DB Series Switch-Rated plugs and receptacles use an internal spring-loaded operating mechanism to open and close the contacts at high speed, independent of the manual motion of the user.

Load-Making

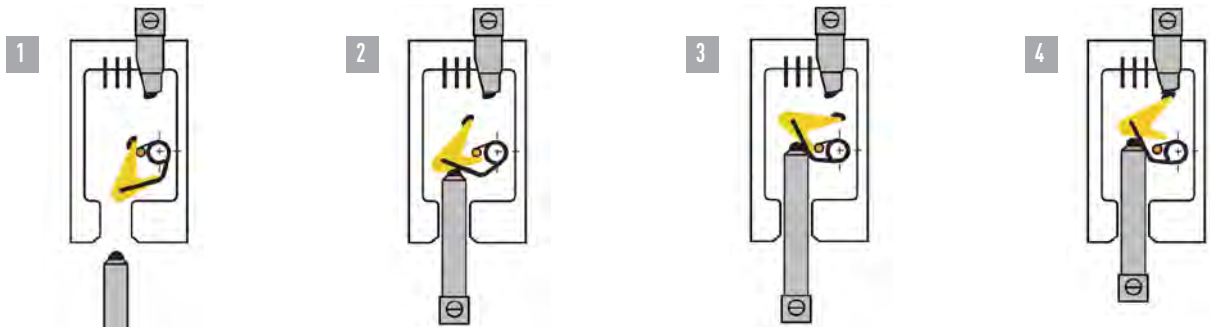

1. As the plug is first inserted into the receptacle, the contact travels toward the operating mechanism. Only the receptacle contact (shown at the top of the drawing) is live.
2. As the plug contact is inserted further, it engages a mobile intermediate contact on the operating mechanism, which it begins to move around a stop. This motion also begins to wind the operating spring.
3. As the plug is inserted further, to the almost completely engaged position, the operating spring becomes fully loaded and the mobile contact rotates into a position where any further insertion motion will release it from the stop.
4. As the last small insertion motion is made, the mobile contact clears the stop and releases the energy in the spring. This instantly drives the mobile contact into engagement with the receptacle contact and completes the electrical connection.

Load-Breaking

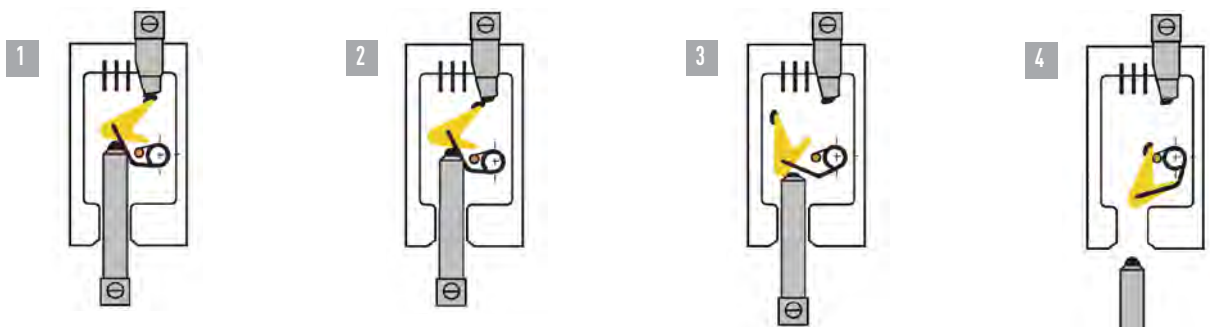

1. When the contacts are engaged, the operating spring is still almost fully charged. This maintains contact pressure and provides energy for the breaking operation.
2. In order to break the circuit, the plug retaining ring is turned to the 'off' position. This releases the plug, which in turn releases the mobile contact and the spring energy in the operating mechanism.
3. The spring energy instantly drives the mobile contact away from the live receptacle contact. It follows a different path than on making and is moved along an arc chute.
4. The mobile contact returns to its initial position, preparing the device to be used again.

Two Stage Contact System

The operation of the DB's contacts was specifically designed to ensure that load-breaking and load-carrying are performed in separate locations on the contacts.

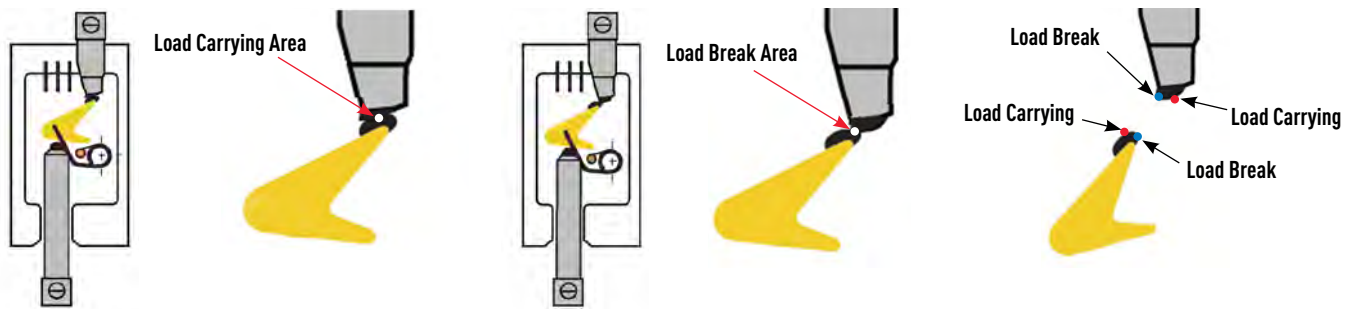

This is accomplished with the motion of the mobile contact relative to the receptacle contact. The opening of the contacts begins with a wiping action that moves the contact area toward the edges of the contacts, where load-breaking occurs. This allows numerous overload-breaking operations without deteriorating the main contact surfaces or the continuity of the connection.

Arc-Extinguishing System

For higher currents, or when significant overloads are involved, additional provision is desirable to handle the arcing that occurs during load-breaking. MELTRIC accomplishes this on its DB Series with a series of magnetic V-shaped blades, which create an arc chute.

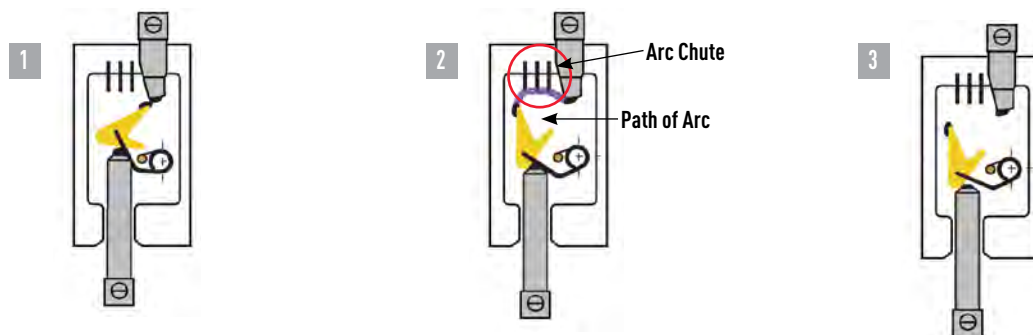

As the contacts open, the mobile intermediate contact moves along the arc chute. The arc is transferred to the magnetic "V" shaped blades, which splits and destabilizes it. This helps to cool and quickly extinguish the arc, minimizing any potential damage to the contacts. Together with the spring operator, two stage contact system and silver-nickel butt style contacts, this feature allows the DB series to easily and safely break high horsepower inductive loads and significant overloads.

DB30



DB – 30A Switch-Rated Plugs & Receptacles

UL/CSA Ratings

- **Max Amperage & Voltage**
30A, 600 VAC
- **Switch-Rating (AC Only)**
Branch Circuit & Motor Circuit Disconnect Switching
- **Horsepower Ratings**

120V	1Ø	2 hp
240V	1Ø	3 hp
208V	3Ø	7 1/2 hp
240V	3Ø	7 1/2 hp
480V	3Ø	20 hp
600V	3Ø	25 hp
- **Short Circuit Rating**
100kA Close & Withstand
Testing was performed with RK1 current limiting fuses sized at 400% of the highest full load motor ampacity associated with the devices hp rating.
- **Environmental Ratings**
IP67
- **Temperature Range**
Min -40°F/Max 140°F
See pg 234 for temps below -15°F.
- **Wiring Capacity**
Min 14 AWG Max 8 AWG
Aux Contacts - Max 14 AWG
- **Applicable Standards**
UL 2682, CSA 182.1

Receptacle (female)



Inlet (male)



North American UL/CSA Configurations

Voltage	Polarity	Part # Metal	Voltage	Polarity	Part # Metal
120V	1P+N+G	89-34165	120V	1P+N+G	89-38165
120/208V	3P+N+G	89-34167	120/208V	3P+N+G	89-38167
125V	1P+N+G	89-34075	125V	1P+N+G	89-38075
125/250V	2P+N+G	89-34076	125/250V	2P+N+G	89-38076
208V	2P+G	89-34162	208V	2P+G	89-38162
208V	3P+G	89-34163	208V	3P+G	89-38163
250V	2P+G	89-34072	250V	2P+G	89-38072
250V	3P+G	89-34073	250V	3P+G	89-38073
277V	1P+N+G	89-34045	277V	1P+N+G	89-38045
277/480V	3P+N+G	89-34047	277/480V	3P+N+G	89-38047
347/600V	3P+N+G	89-34147	347/600V	3P+N+G	89-38147
480V	2P+G	89-34042	480V	2P+G	89-38042
480V	3P+G	89-34043	480V	3P+G	89-38043
600V	2P+G	89-34142	600V	2P+G	89-38142
600V	3P+G	89-34143	600V	3P+G	89-38143

For international configurations and ratings (IEC, CE) visit meltric.com/international-catalog or contact customer service at 800.433.7642.

Main Options



Auxiliary/Pilot Contacts

Receptacle Options

Suffix

With 2 Auxiliary/Pilot Contacts Recept # - 172*

Inlet Options

Suffix

With 2 Auxiliary/Pilot Contacts Inlet # - 172*

* Auxiliary/Pilot Contacts are not available on DB devices with 1P+N+G, 2P+N+G or 3P+N+G polarity.

480V DB30 Order Example:

To order 2 auxiliary/pilot contacts on an inlet and receptacle add **-172** to the part numbers.

DB30 Metal inlet 3P+G=89-38043-**172**

DB30 Metal receptacle 3P+G=89-34043-**172**

Appropriate accessory part numbers must also be included on the order.

How to Order

Receptacle and Inlet (see above)



Accessories

Angle, Handle, etc are interchangeable (see opposite page)



See pgs 211-220 for detailed information on these options

Installation Accessories

Handles



NPT	Poly Handle	Metal Handle
1/2"	3PH12	3H12
3/4"	3PH34	3H34
1"	3PH1	3H1
1 1/4"	3PH114	3H114
1 1/2"	-	3H112

Cable Range	Poly Handle w/Clamp & Bushing	Nylon Handle
.39 - 1.18	-	FH311
.750 - .875	3PM514	-
.875 - 1.000	3PM516	-
1.000 - 1.125	3PM518	-
1.125 - 1.250	3PM520	-
1.250 - 1.375	3PM522	-

Notes: • For available cord grips, see pgs 169-170.

Angles



Metal 30° Angle	Metal 70° Angle	Metal Angle FS/FD Box 30°	Metal Straight Adapter
MA3	89-3A027	MAFS3*	MS3

* MAFS3 base measures approximately 4.2" x 2.7". Due to the variation in sizes of FS boxes, please verify that your FS box matches our dimensions, if not call Customer Service for other solutions.

Junction Boxes



NPT	Metal Box	Metal Box with Metal Angle
1/2"	MB312	89-3A053-080-12
3/4"	MB334	89-3A053-080-34
1"	MB31	89-3A053-080-1
1 1/4"	MB3114	89-3A053-080-114

* Interior volume with receptacle installed.

Miscellaneous Accessories



For Male Devices Only

Protective Cap

89-3A126



Cord Grip with Mesh

see pgs 169-170

NPT Guidelines

Cable Range	NPT
.312 - .625	1/2"
.438 - .812	3/4"
.660 - 1.000	1"
.875 - 1.375	1 1/4"

NPT sizes are determined by the cable diameter and third party cord grip.

Order Example

A typical order should include an inlet part number, a receptacle part number **AND** the matching handles, angles or other required accessories.



Male Inlet with Handle (Plug)
89-38075 + FH311



Female Receptacle with Angle Adapter
89-34075 + 89-3A027

DB60



DB – 60A Switch-Rated Plugs & Receptacles

UL/CSA Ratings

- **Max Amperage & Voltage**
60A, 600 VAC
- **Switch-Rating (AC Only)**
Branch Circuit & Motor Circuit Disconnect Switching
- **Horsepower Ratings**

120V	1Ø	3 hp
240V	1Ø	15 hp
208V	3Ø	15 hp
240V	3Ø	15 hp
480V	3Ø	30 hp
600V	3Ø	30 hp
- **Short Circuit Rating**
100kA Close & Withstand
Testing was performed with RK1 current limiting fuses sized at 400% of the highest full load motor ampacity associated with the devices hp rating.
- **Environmental Ratings**
IP67
- **Temperature Range**
Min -40°F/Max 140°F
See pg 234 for temps below -15°F.
- **Wiring Capacity**
Min 8 AWG Max 3 AWG
Aux Contacts - Max 14 AWG
- **Applicable Standards**
UL 2682, CSA 182.1

Receptacle (female)



Don't forget to add installation accessories to your order

Inlet (male)



North American UL/CSA Configurations

Voltage	Polarity	Part # Metal	Voltage	Polarity	Part # Metal
120V	1P+N+G	89-64165	120V	1P+N+G	89-68165
120/208V	3P+N+G	89-64167	120/208V	3P+N+G	89-68167
125V	1P+N+G	89-64075	125V	1P+N+G	89-68075
125/250V	2P+N+G	89-64076	125/250V	2P+N+G	89-68076
208V	2P+G	89-64162	208V	2P+G	89-68162
208V	3P+G	89-64163	208V	3P+G	89-68163
250V	2P+G	89-64072	250V	2P+G	89-68072
250V	3P+G	89-64073	250V	3P+G	89-68073
277V	1P+N+G	89-64045	277V	1P+N+G	89-68045
277/480V	3P+N+G	89-64047	277/480V	3P+N+G	89-68047
347/600V	3P+N+G	89-64147	347/600V	3P+N+G	89-68147
480V	2P+G	89-64042	480V	2P+G	89-68042
480V	3P+G	89-64043	480V	3P+G	89-68043
600V	2P+G	89-64142	600V	2P+G	89-68142
600V	3P+G	89-64143	600V	3P+G	89-68143

For international configurations and ratings (IEC, CE) visit meltric.com/international-catalog or contact customer service at 800.433.7642.

Main Options



Auxiliary/Pilot Contacts

Receptacle Options

Suffix

With 2 Auxiliary/Pilot Contacts Recept # - 172*

Inlet Options

Suffix

With 2 Auxiliary/Pilot Contacts Inlet # - 172*

* Auxiliary/Pilot Contacts are not available on DB devices with 1P+N+G, 2P+N+G or 3P+N+G polarity.

480V DB60 Order Example:

To order 2 auxiliary/pilot contacts on an inlet and receptacle add **-172** to the part numbers.

DB60 Metal inlet 3P+G=89-68043-**172**

DB60 Metal receptacle 3P+G=89-64043-**172**

Appropriate accessory part numbers must also be included on the order.

How to Order

Receptacle and Inlet (see above)



Accessories

Angle, Handle, etc are interchangeable (see opposite page)



See pgs 211-220 for detailed information on these options

Installation Accessories

Handles



NPT	Poly Handle	Metal Handle	Cable Range	Poly Handle w/Clamp & Bushing	Nylon Handle
1/2"	6PH12	6H12	.51 - 1.38	-	FH611
3/4"	6PH34	6H34	1.250 - 1.375	6PM622	-
1"	6PH1	6H1	1.438 - 1.562	6PM625	-
1 1/4"	6PH114	6H114	1.562 - 1.688	6PM627	-
1 1/2"	6PH112	6H112	1.688 - 1.812	6PM629	-

Notes: • For available cord grips, see pgs 169-170.

Angles

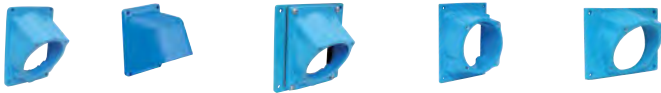

Metal 30° Angle	Metal 70° Angle	Metal Angle ⁺ Oversized 30°	Metal Straight Adapter	Metal Lateral Angle 30°
MA6	89-6A027	MA660	MS6	MAB6

⁺ Mounts on oversize box only. Order with MB10xxx box. See page 64.

Junction Boxes



NPT	Metal Box	Metal Box with Metal Angle
1"	MB61	89-6A053-080-1
1 1/4"	MB6114	89-6A053-080-114
1 1/2"	MB6112	89-6A053-080-112
2"	MB62	89-6A053-080-2

⁺ Interior volume with receptacle installed.

Miscellaneous Accessories



For Male Devices Only

Protective Cap

89-6A126



Cord Grip with Mesh

see pgs 169-170

NPT Guidelines

Cable Range	NPT
.312 - .625	1/2"
.438 - .812	3/4"
.660 - 1.000	1"
.875 - 1.375	1 1/4"
.890 - 1.812	1 1/2"

NPT sizes are determined by the cable diameter and third party cord grip.

Order Example

A typical order should include an inlet part number, a receptacle part number **AND** the matching handles, angles or other required accessories.



Male Inlet with Handle (Plug)
89-68043 + FH611



Female Receptacle with Angle Adapter
89-64043 + 89-6A027

DB100



DB – 100A Switch-Rated Plugs & Receptacles

UL/CSA Ratings

- **Max Amperage & Voltage**
100A, 600 VAC
- **Switch-Rating (AC Only)**
Branch Circuit & Motor Circuit Disconnect Switching
- **Horsepower Ratings**
 - 120V 1Ø 7 1/2 hp
 - 240V 1Ø 15 hp
 - 208V 3Ø 30 hp
 - 240V 3Ø 30 hp
 - 480V 3Ø 60 hp
 - 600V 3Ø 60 hp
- **Short Circuit Rating**
100kA Close & Withstand
Testing was performed with 250A RK1 fuses, so the 100kA rating applies up to 60 hp @ 600, 40 hp @ 480V and 20 hp @ 240V and 208V.
- **Environmental Ratings**
IP67
- **Temperature Range**
Min -40°F/Max 140°F
See pg 234 for temps below -15°F.
- **Wiring Capacity**
Min 1/0+ AWG Max 2/0 AWG
Aux Contacts - Max 14 AWG
* Smaller conductors can be retained in the terminal, but may result in a temperature rise greater than the 30° max allowed in UL & CSA standards.
- **Applicable Standards**
UL 2682, CSA 182.1

Receptacle (female)



Don't forget to add installation accessories to your order

Inlet (male)



North American UL/CSA Configurations

Voltage	Polarity	Part # Metal
120V	1P+N+G	89-94165
120/208V	3P+N+G	89-94167
125V	1P+N+G	89-94075
125/250V	2P+N+G	89-94076
208V	2P+G	89-94162
208V	3P+G	89-94163
250V	2P+G	89-94072
250V	3P+G	89-94073
277V	1P+N+G	89-94045
277/480V	3P+N+G	89-94047
347/600V	3P+N+G	89-94147
480V	2P+G	89-94042
480V	3P+G	89-94043
600V	2P+G	89-94142
600V	3P+G	89-94143

Voltage	Polarity	Part # Metal
120V	1P+N+G	89-98165
120/208V	3P+N+G	89-98167
125V	1P+N+G	89-98075
125/250V	2P+N+G	89-98076
208V	2P+G	89-98162
208V	3P+G	89-98163
250V	2P+G	89-98072
250V	3P+G	89-98073
277V	1P+N+G	89-98045
277/480V	3P+N+G	89-98047
347/600V	3P+N+G	89-98147
480V	2P+G	89-98042
480V	3P+G	89-98043
600V	2P+G	89-98142
600V	3P+G	89-98143

For international configurations and ratings (IEC, CE) visit meltric.com/international-catalog or contact customer service at 800.433.7642.

Main Options



Auxiliary/Pilot Contacts

Receptacle Options

Suffix

With 4 Auxiliary/Pilot Contacts Recept # - 174**

Inlet Options

Suffix

With 4 Auxiliary/Pilot Contacts Inlet # - 174**

* DB100 devices with auxiliary/pilot contacts are not UL/CSA listed.

** Auxiliary/Pilot Contacts are not available on DB devices with 1P+N+G, 2P+N+G or 3P+N+G polarity.

480V DB100 Order Example:

To order 4 auxiliary/pilot contacts on an inlet and receptacle add **-174** to the part numbers.

DB100 Metal inlet 3P+G=89-98043-**174**

DB100 Metal receptacle 3P+G=89-94043-**174**

Appropriate accessory part numbers must also be included on the order.

How to Order

Receptacle and Inlet (see above)



Accessories

Angle, Handle, etc are interchangeable (see opposite page)



See pgs 211-220 for detailed information on these options

Installation Accessories

Handles



IP 66/67



NPT	Poly Handle	Metal Handle
3/4"	9PH34	9H34
1"	9PH1	9H1
1 1/4"	9PH114	9H114
1 1/2"	9PH112	9H112
2"	9PH2	9H2

Cable Range	Santoprene™ Handle	Poly Handle w/Clamp & Bushing
.70 - 1.00	65-9A013-D25	-
1.00 - 1.375	65-9A013-D35	-
1.250 - 1.375	-	9PM622
1.375 - 1.750	65-9A013-D45	-
1.438 - 1.562	-	9PM625
1.562 - 1.688	-	9PM627
1.688 - 1.812	-	9PM629

Notes: • For available cord grips, see pgs 169-170.

Angles



Metal 30° Angle	Metal 70° Angle	Metal Angle+ Oversized 30°	Metal Straight Adapter
MA10	89-9A027	MA110	MS10

* Mounts on oversize box only. Order with MB22xxx box. See page 50.

NPT Guidelines

Cable Range	NPT
.438 - .812	3/4"
.660 - 1.000	1"
.875 - 1.375	1 1/4"
.890 - 1.812	1 1/2"
1.190 - 2.438	2"

NPT sizes are determined by the cable diameter and third party cord grip.

Junction Boxes



175.0 in³*

NPT	Metal Box	Metal Box with Metal Angle
1 1/4"	MB10114	89-9A053-080-114
1 1/2"	MB10112	89-9A053-080-112
2"	MB102	89-9A053-080-2

* Interior volume with receptacle installed.

Miscellaneous Accessories



For Male Devices Only



Protective Cap	Cord Grip with Mesh
89-9A126	see pgs 169-170

Order Example

A typical order should include an inlet part number, a receptacle part number **AND** the matching handles, angles or other required accessories.



Male Inlet with Handle (Plug)
89-98043 + 9PM622



Female Receptacle with Angle Adapter
89-94043 + 89-9A027



Spare Parts Male Configuration

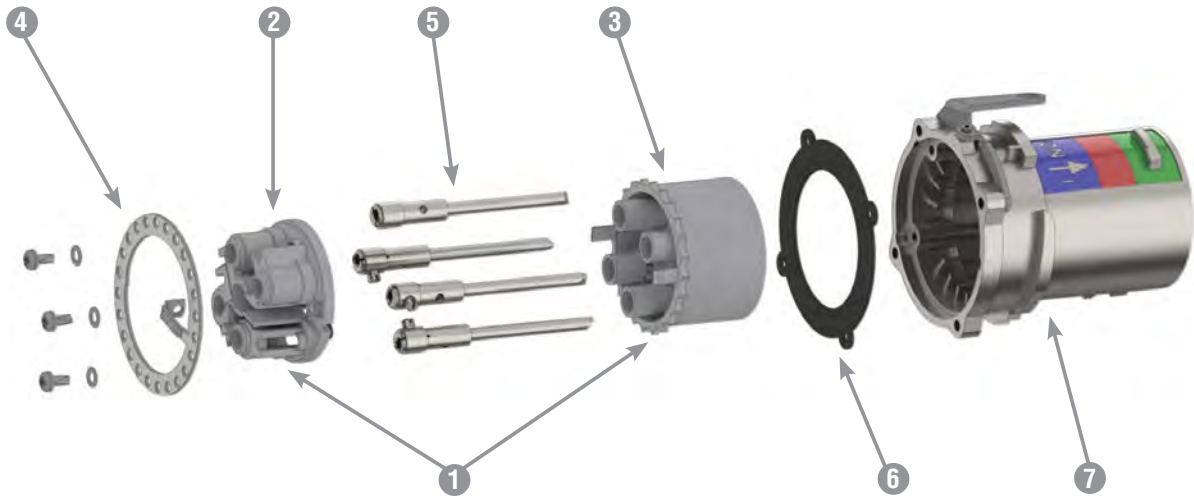

	DB30 METAL	DB60 METAL	DB100 METAL
1 = Plug Interior with Pilot Contact Assembly	89-3A010-172*	89-6A010-172*	89-9A010-174*
1 = Plug Interior without Pilot Contact Assembly	89-3A010*	89-6A010*	89-9A010*
2 = Interior Bottom	89-3A010-B	89-6A010-B	89-9A010-B
3 = Interior Top for Pilot Contact Assembly	89-3A010-T-172*	89-6A010-T-172*	89-9A010-T-174*
3 = Interior Top without Pilot Contact Assembly Holes	89-3A010-T*	89-6A010-T*	89-9A010-T*
4 = Metal Locking Ring/Ground Ring	89-3A523	89-6A523	89-9A523
5 = Ground Contact	89-3A019	89-6A019	89-9A019
5 = Phase or Neutral Contact	89-3A011	89-6A011	89-9A011
5 = Pilot (2 Contacts) Assembly (not shown)	89-3A219-172	89-6A219-172	-
5 = Pilot (4 Contacts) Assembly (not shown)	-	-	89-9A219-174
6 = Device Gasket	89-3A026	89-6A026	89-9A026
7 = Plug Metal Casing	89-3A014**	89-6A014**	89-9A014**

* Voltage and phasing positions must be specified (5th, 6th & 7th digit of Part #) to duplicate your shutter and alignment notches.

** For appropriate labeling on a device, please specify voltage, phasing, and product type.

Spare Parts

Female Configuration

DB

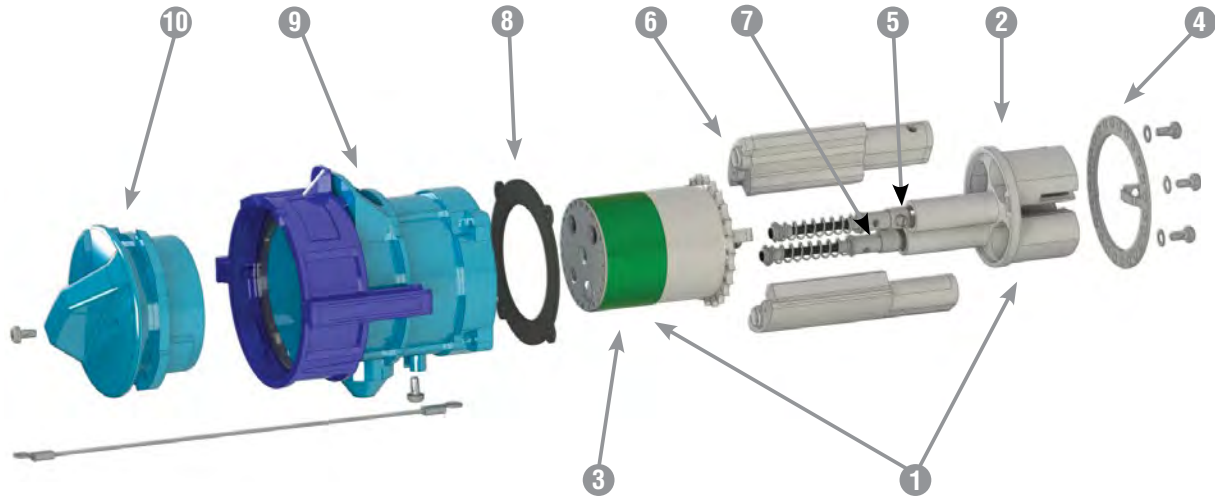

	DB30 METAL	DB60 METAL	DB100 METAL
1 = Receptacle Interior with Pilot Contact Assembly	89-3A020-172*	89-6A020-172*	89-9A020-174*
1 = Receptacle Interior without Pilot Contact Assembly	89-3A020*	89-6A020*	89-9A020*
2 = Interior Bottom	89-3A020-B	89-6A020-B	89-9A020-B
3 = Interior Top for Pilot Contact Assembly	89-3A020-T-172*	89-6A020-T-172*	89-9A020-T-174*
3 = Interior Top without Pilot Contact Assembly Holes	89-3A020-T*	89-6A020-T*	89-9A020-T*
4 = Metal Locking Ring/Ground Ring	89-3A523	89-6A523	89-9A523
5 = Ground Contact	89-3A029	89-6A029	89-9A029
6 = Phase Contact	89-3A021	89-6A021	89-9A021
7 = Neutral Contact	89-3A021N	89-6A021N	89-9A021N
7 = Pilot (2 Contacts) Assembly (not shown)	89-3A229-172	89-6A229-172	-
7 = Pilot (4 Contacts) Assembly (not shown)	-	-	89-9A229-174
8 = Device Gasket	89-3A026	89-6A026	89-9A026
9 = Receptacle Metal Casing	89-3A024**	89-6A024**	89-9A024**
10 = Protective Cap with Nylon Cord	89-3A925**	89-6A925**	89-9A925**

* Voltage and phasing positions must be specified (5th, 6th & 7th digit of Part #) to duplicate your shutter and alignment notches.

** For appropriate labeling on a device, please specify voltage, phasing, and product type.

DB



Dimensions

Inlet – Provided in inches

Dimensions are for reference only and may change depending on accessories used. For precise dimensions contact MELTRIC Engineering.

plug

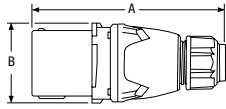

PRODUCT	A	B
DB30	7.86	3.15
DB60	8.26	3.67
DB100	9.78	4.46

Inlet

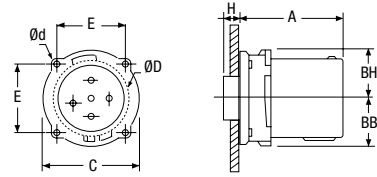

PRODUCT	A	BB	BH	C	E	H	Ød
DB30	3.75	1.50	1.61	3.03	2.17	0.67	0.18
DB60	3.90	1.77	2.13	3.59	2.59	0.73	0.22
DB100	4.63	2.09	2.24	4.57	3.2	1.65	0.22

70° inclined inlet/angle with connector

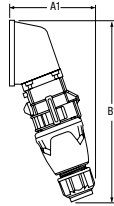

PRODUCT	A1	B1
DB30	6.57	11.54
DB60	7.36	13.46
DB100	9.57	17.80

70° inlet/angle

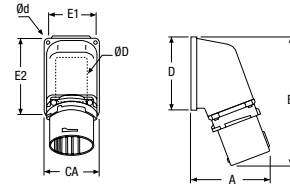

PRODUCT	A	B	CA	D	E1	E2	Ød	ØD
DB30	4.61	7.28	3.03	4.17	2.48	3.74	0.22	2.64
DB60	5.35	8.74	4.02	5.35	3.43	4.80	0.26	3.19
DB100	6.42	9.88	5.51	5.51	4.88	4.88	0.26	4.02

70° inclined inlet/angle/box with connector

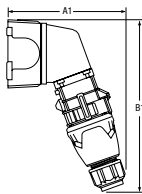

PRODUCT	A1	B1
DB30	8.54	11.65
DB60	9.96	13.66
DB100	12.24	17.60

inlet with connector

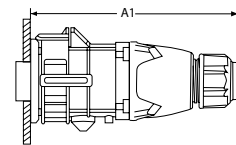

PRODUCT	A1
DB30	8.90
DB60	9.19
DB100	11.50

70° surface inlet/angle/metal junction box

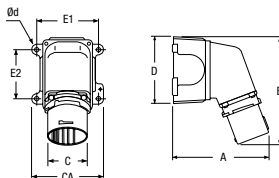

PRODUCT	A	B	CA	D	E1	E2	Ød
DB30	7.09	7.40	4.40	4.50	4.19	2.75	0.25
DB60	8.48	8.94	5.75	5.84	5.00	3.82	0.31
DB100	10.04	9.88	7.50	5.50	6.75	4.24	0.31



Dimensions

Receptacle – Provided in inches

Dimensions are for reference only and may change depending on accessories used. For precise dimensions contact MELTRIC Engineering.

connector

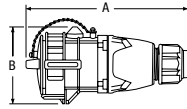

PRODUCT	A	B
DB30	9.26	4.16
DB60	9.83	4.94
DB100	11.91	5.75

receptacle

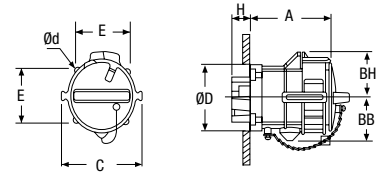

PRODUCT	A	BB	BH	C	E	H	Ød	ØD
DB30	5.16	1.77	1.77	4.36	2.17	1.01	0.18	3.05
DB60	5.46	2.01	2.01	4.86	2.59	1.06	0.22	3.60
DB100	6.77	2.45	2.48	5.75	3.20	1.75	0.22	4.50

70° inclined receptacle/angle with plug

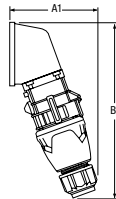

PRODUCT	A1	B1
DB30	6.57	11.54
DB60	7.36	13.46
DB100	9.57	17.80

70° receptacle/angle

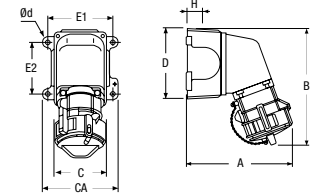

PRODUCT	A	B	CA	D	E1	E2	Ød
DB30	5.24	7.83	3.03	4.17	2.48	3.74	0.22
DB60	6.10	9.72	4.02	5.35	3.43	4.80	0.26
DB100	7.13	10.55	5.51	5.51	4.88	4.88	0.28

70° inclined receptacle/angle/ junction box with plug

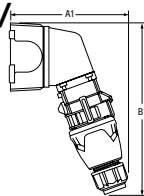

PRODUCT	A1	B1
DB30	8.54	11.65
DB60	9.96	13.66
DB100	12.24	17.60

receptacle with plug

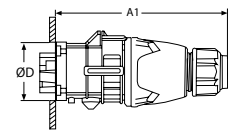

PRODUCT	A1	ØD
DB30	8.90	3.05
DB60	9.19	3.60
DB100	11.50	4.50

70° receptacle/angle/ metal junction box

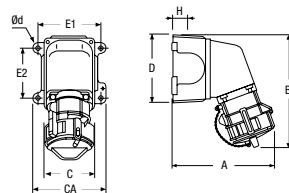

PRODUCT	A	B	CA	CP	D	E1	E2	H	PG	Ød
DB30	7.72	7.95	3.31	4.40	4.50	4.19	2.75	1.10	1.00	0.27
DB60	9.21	9.92	4.49	5.75	5.84	5.00	3.82	1.50	1.50	0.33
DB100	10.75	10.55	5.51	7.50	5.50	6.75	4.24	1.84	2.00	0.31

MULTIPIIN

Summary and Specifications	p. 70
PN7c	p. 71
PN12c	p. 73
PN12c Stainless	p. 75
DSN24c/ DS24c Stainless	p. 77
DSN37c/ DS37c Stainless	p. 79
DN9c	p. 81
DN20c	p. 83
DS7c	p. 85
DR7c	p. 87



Superior contact technology maximizes durability and performance

MELTRIC offers a broad range of multipin devices for use in a wide variety of control and power applications. Devices are available with as many as 37 or as few as 4 contacts. Products range from 2A up to 50A and some include load making and breaking capabilities.

Main Advantages

- ▶ Spring-loaded, silver-nickel, butt-style contacts
- ▶ Robust casing materials made of fiberglass reinforced thermoplastic polyester, epoxy coated zamak, or stainless steel (depending on the model type and size).

Product Features

Product Line Summary

PN7c plugs and receptacles are excellent for use when between 5 and 7 contacts are required with amperages up to 20A.

PN12c multipin plugs and receptacles are ideal for low amperage applications requiring compact devices. IP66+67 watertightness provides protection in washdown environments.

DSN 24c/37c plugs and receptacles are excellent for frequent low ampacity connecting and disconnecting application. Up to 37 contacts are available on the device which is rated up to Type 4X/IP 66+67.

DN9c and DN20c devices are horsepower rated and allow multiple power circuits or a combination of power and control circuits in a single connection.

DN7c, DR7c, and DS7c multipins are excellent for those difficult, higher amperage environments where there is a need for frequent connecting and disconnecting. DS7c devices are current interrupting rated for up to 30 amps per contact, and like the DR7c allow the addition of up to 3 auxiliary contacts.



MULTIPIN

Multipin Product Specifications

Product Type	Housing Material	Voltage (Max)	Number of Contacts Min / Max		Amperage		Wiring Capacity Min / Max		Environmental Rating	Wiring Connection	Catalog Page
					Current Interrupting	Non-Current Interrupting					
PN7c**	Polyester	600	4P+G	6P+G	15	20	18 AWG	10 AWG	IP66/IP67	Screw	71
PN7c**	Metal	600	4P+G	6P+G	15	20	18 AWG	10 AWG	IP66/IP67	Screw	71
PN7c	Stainless	600	4P+G	6P+G	15	20	18 AWG	10 AWG	-	Screw	71
PN12c	Polyester	600	1	11P+G	5	7.5	18 AWG	14 AWG	IP66/IP67	Solder/Crimp	73
PN12c	Metal	600	1	11P+G	5	7.5	18 AWG	14 AWG	IP66/IP67	Solder/Crimp	73
PN12c	Stainless	600	1	11P+G	5	7.5	18 AWG	14 AWG	-	Solder/Crimp	75
DSN24c	Polyester	480	1	24	2	7.5	18 AWG	14 AWG	IP66/IP67	Solder/Crimp	77
DS24c	Stainless	250	1	24	2	7.5	18 AWG	14 AWG	-	Solder/Crimp	77
DSN37c	Polyester	480	1	37	2	7.5	18 AWG	14 AWG	IP66/IP67	Solder/Crimp	79
DS37c	Stainless	480	1	37	2	7.5	18 AWG	14 AWG	-	Solder/Crimp	79
DN9c	Metal	480	6	9	20	-	16 AWG	10 AWG	IP54/IP55*	Screw	81
DN20c	Metal	480	10	20	20*	-	16 AWG	10 AWG	IP54/IP55*	Screw	83
DS7c	Polyester	600	4	7	30	-	14 AWG	8 AWG	IP54/IP55*	Screw	85
DS7c	Metal	600	4	7	30	-	14 AWG	8 AWG	IP54/IP55*	Screw	85
DR7c	Polyester	600	4	7	-	50	14 AWG	8 AWG	IP54/IP55*	Screw	87
DR7c	Metal	600	4	7	-	50	14 AWG	8 AWG	IP54/IP55*	Screw	87

* Rated IP54 when receptacle and plug are mated, when not mated receptacle alone is rated IP55 provided that the lid is latched closed.

* The rating is reduced to 15A when more than 12 contacts are used for power circuits (not control).

** UL 1682 Listed.

PN7c



PN7c Multipin – 20A

Poly/Stainless Steel Plugs & Receptacles

Ratings

- **Voltage**
600 VAC Max/130 VDC*
- **Amperage Rating**
15A Current Interrupting
20A Non-Current Interrupting
- **Environmental Ratings**
IP66/IP67*
- **Temperature Range**
Min -40°F / Max 140°F
See pg 234 for temps below -15°F.
- **Wiring Capacity**
Min 18 AWG Max 10 AWG
- **Applicable Standards**
UL*, CSA*, CE*
* Contact Customer Service
* Poly/metal versions only

For PN7c dimensions, see pgs 117-118

Receptacle (female)



Don't forget to add installation accessories to your order

Inlet (male)



North American Configurations

Voltage	Polarity	Part #		
		Poly	Metal	Stainless Steel
600V	4P+G	01-P4041	09-P4041	09-04041-SS
600V	5P+G	01-P4051	09-P4051	09-04051-SS
600V	6P+G	01-P4061	09-P4061	09-04061-SS

Voltage	Polarity	Part #		
		Poly	Metal	Stainless Steel
600V	4P+G	01-P8041	09-P8041	09-08041-SS
600V	5P+G	01-P8051	09-P8051	09-08051-SS
600V	6P+G	01-P8061	09-P8061	09-08061-SS

For international configurations and ratings (IEC,CE) visit meltric.com/international-catalog or contact customer service at 800.433.7642.

Main Options



Reverse Interiors



Flush Mount
(replaces female casing)



Locking Pawl

Receptacle Options

Part

Reverse Interiors	Recept # - 001
With Flush Mount (poly only)	Recept # - 142
Locking Pawl	Recept # - 824-300

Inlet Options

Part

Reverse Interiors	Inlet # - 001
-------------------	---------------

PN7c Order Example:

To order a device with a reverse interior add **-001** to the inlet and receptacle part numbers.

PN7c Receptacle 5P+G 01-P4051-**001**

PN7c Inlet 5P+G 01-P8051-**001**

Appropriate accessory part numbers must also be included on the order.



See pgs 211-220 for detailed information on these options

Installation Accessories

Accessories can be used with either poly or metal plugs and receptacles, except stainless steel accessories should only be used with stainless inlets and receptacles.

Handles



NPT	Poly Handle Threaded Opening	Metal Handle* Threaded Opening	90° Nylon Handle Threaded Opening	Stainless Steel Handle	Cable Range	Nylon Handle	Angled Nylon Handle
1/2"	01-NA013-12	H091U12	04-2A090-5-12	09-2A013-SS-12*	.35 - .69	01-NA013	01-NA313
3/4"	01-NA013-34	H091U34	04-2A090-5-34	09-2A013-SS-34			
1"	01-NA013-1	H091U1	04-2A090-5-10	-			

- Notes:**
- For available cord grips, see pgs 169-170.
 - * For metal devices only.
 - + For 1/2" NPT size, a hole size reducer is utilized.

NPT Guidelines

Cable Range	NPT
.312 - .625	1/2"
.438 - .812	3/4"
.660 - 1.000	1"
.875 - 1.375	1 1/4"

NPT sizes are determined by the cable diameter and third party cord grip.

Junction Boxes



NPT	Metal Box	Metal Box with Nylon 30° Angle	Metal Box with Metal 45° Angle	Poly Conduit* Entry	Poly Straight* Wall Box	Metal Straight Wall Box	Stainless Steel Angle with Stainless Steel Box	Poly 70°** Wall Box
1/2"	MB312	01-NA053-080-12	09-NA053-080-12	01-NA023-12	01-NA025-12	09-NA025-12	-	51-AA058
3/4"	MB334	01-NA053-080-34	09-NA053-080-34	01-NA023-34	01-NA025-34	09-NA025-34	-	51-AA058
1"	MB31	01-NA053-080-1	09-NA053-080-1	-	-	-	09-2A053-080-SS-1	51-AA058
1 1/4"	MB3114	01-NA053-080-114	09-NA053-080-114	-	-	-	-	51-AA058

- * For poly devices only.
 ** 70° boxes are not drilled. Contact customer service if factory drilling is required.
 + Interior volume with receptacle installed.

Angles

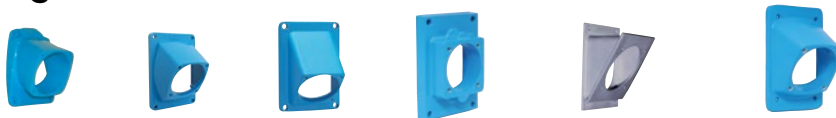

Nylon 30° Angle	Nylon 30° Angle for MB Box	Metal 45° Angle	Metal Straight Adapter	Stainless Steel 30° Angle	Metal 30° Angle for FS Box
01-NA027	01-NA027-601	09-NA027	MSPN	09-2A027-SS	MAFS1*

* MAFS1 base measures approximately 4.2" x 2.7". Due to the variation in sizes of FS boxes, please verify that your FS box matches our dimensions, if not call Customer Service for other solutions.

Miscellaneous Accessories



Protective* Cap	Flush Mount	Cord Grip with Mesh
01-2A126	01-2A142	see pgs 169-170

* Will not fit devices with reverse interior option.

Order Example

A typical order should include an inlet part number, a receptacle part number **AND** the matching handles, angles or other required accessories.



Male Inlet with Handle (Plug)
09-P8061 + 01-NA313



Female Receptacle with Angle Adapter
09-P4061 + 01-NA027

PN12c



PN12c Multipin – 7.5A Plugs & Receptacles

Ratings

- **Voltage**
600 VAC Max/130 VDC
- **Amperage Rating**
5A Current Interrupting
7.5A Non-Current Interrupting
! PN12c is capable of handling
4-20mA low current applications
- **Environmental Ratings**
IP66/IP67
- **Temperature Range**
Min -40°F/ Max 140°F
See pg 234 for temps below -15°F.
- **Wiring Capacity**
Min 18 AWG Max 14 AWG
- **Applicable Standards**
UL Coming Soon!

For PN12c dimensions, see pgs 117-118

Highlighted Feature

- **Crimped Contacts**
PN12c devices now feature contacts that can be crimped or soldered. Each device is supplied with 13 contacts so that the product can be set up to suit application needs.

Main Options



Reverse Interiors



Flush Mount
(replaces female casing)



Locking Pawl



See pgs 211-220 for detailed information on these options

Receptacle (female)



Don't forget to add installation accessories to your order

Inlet (male)



North American Configurations

Voltage	Polarity	Part #	
		Poly	Metal
600V	11P+G	03-A4001	07-A4001

Voltage	Polarity	Part #	
		Poly	Metal
600V	11P+G	03-A8001	07-A8001

For international configurations and ratings (IEC,CE) visit meltric.com/international-catalog or contact customer service at 800.433.7642.

Simple Assembly and Disassembly

DSN37c shown



Assembly

To insert contacts when they have been wired is simple. Push wired contact into rear of insulator until it stops to complete the installation.



Disassembly

To remove, use the tool provided. Push tool from front onto contact until tool stops. Contact is then released at rear of insulator.

Receptacle Options	Part #
Reverse Interiors	Recept # - 001
With Flush Mount (poly only)	Recept # - 142
Locking Pawl	Recept # - 824-300

Inlet Options	Part #
Reverse Interiors	Inlet # - 001

600V PN12c Order Example:

To order a device with a reverse interior add **-001** to the inlet and receptacle part numbers.

PN12c Receptacle 5P+G 03-A4001-**001**

PN12c Inlet 5P+G 03-A8001-**001**

Appropriate accessory part numbers must also be included on the order.

Installation Accessories

Unless indicated otherwise, accessories can be used with either poly or metal plugs and receptacles.

Handles



NPT	Poly Handle Threaded Opening	Metal Handle* Threaded Opening	90° Nylon Handle Threaded Opening
1/2"	01-NA013-12	H091U12	04-2A090-5-12
3/4"	01-NA013-34	H091U34	04-2A090-5-34
1"	01-NA013-1	H091U1	04-2A090-5-10

Cable Range	Nylon Handle	Angled Nylon Handle
.35 - .70	01-NA013	01-NA313

- Notes:**
- For available cord grips, see pgs 169-170.
 - * For metal devices only.

NPT Guidelines

Cable Range	NPT
.062 - .5	1/2"
.187 - .75	3/4"
.437 - 1.10	1"
.750 - 1.375	1 1/4"

NPT sizes are determined by the cable diameter and third party cord grip.

Junction Boxes



NPT	Metal Box	Metal Box Nylon Angle 30°	Metal Box Metal Angle 45°	Poly Conduit* Entry	Poly Straight* Wall Box	Metal Straight Wall Box	Poly 70°** Wall Box
1/2"	MB312	01-NA053-080-12	09-NA053-080-12	01-NA023-12	01-NA025-12	09-NA025-12	51-AA058
3/4"	MB334	01-NA053-080-34	09-NA053-080-34	01-NA023-34	01-NA025-34	09-NA025-34	51-AA058
1"	MB31	01-NA053-080-1	09-NA053-080-1	-	-	-	51-AA058
1 1/4"	MB3114	01-NA053-080-114	09-NA053-080-114	-	-	-	51-AA058

- * For poly devices only.
- ** 70° boxes are not drilled. Contact customer service if factory drilling is required.
- + Interior volume with receptacle installed.

Angles



Nylon 30° Angle for MB Box	Metal 45° Angle	Metal Straight Adapter	Metal 30° Angle for FS Box
01-NA027-601	09-NA027	MSPN	MAFS1*

* MAFS1 base measures approximately 4.2" x 2.7". Due to the variation in sizes of FS boxes, please verify that your FS box matches our dimensions, if not call Customer Service for other solutions.

Miscellaneous Accessories



Protective* Cap	Flush Mount	Cord Grip with Mesh	Multi-Contact Removal Tool	Crimper Tool (Greenlee or equal)	European Crimping Tool
01-2A126	01-2A142	see pgs 169-170	9-LD12-37	4CN30	61-CA500

* Will not fit devices with reverse interior option.

Order Example

A typical order should include an inlet part number, a receptacle part number **AND** the matching handles, angles or other required accessories.



Male Inlet with Handle (Plug)
07-A8001 + 01-NA313



Female Receptacle with Angle Adapter
07-A4001 + 01-NA027

PN12c



PN12c Multipin – 7.5A Stainless Steel Plugs & Receptacles

Ratings

- **Voltage**
600 VAC Max/130 VDC
- **Amperage Rating**
5A Current Interrupting
7.5A Non-Current Interrupting
! PN12c is capable of handling
4-20mA low current applications
- **Temperature Range**
Min -40°F/Max 140°F
- **Wiring Capacity**
Min 18 AWG Max 14 AWG
- **Applicable Standards**
UL Coming Soon!

For PN12c SS dimensions, contact Customer Service

Highlighted Feature

- **Crimped Contacts**
PN12c devices now feature contacts that can be crimped or soldered. Each device is supplied with 13 contacts so that the product can be set up to suit application needs.

Receptacle (female)



Don't forget to add installation accessories to your order

Inlet (male)



North American Configurations

Voltage	Polarity	Part # Stainless Steel
600V	11P+G	07-A4001-SS

Voltage	Polarity	Part # Stainless Steel
600V	11P+G	07-A8001-SS

For international configurations and ratings (IEC,CE) visit meltric.com/international-catalog or contact customer service at 800.433.7642.

Simple Assembly and Disassembly

DSN37c shown



Assembly

To insert contacts when they have been wired is simple. Push wired contact into rear of insulator until it stops to complete the installation.



Disassembly

To remove, use the tool provided. Push tool from front onto contact until tool stops. Contact is then released at rear of insulator.

PN12c Stainless Steel Multipins are made of machined 304 Stainless Steel.

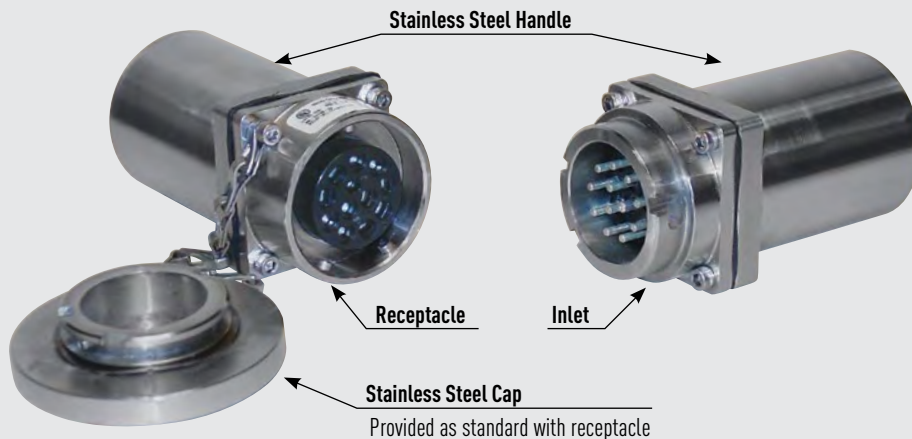

Installation Accessories

Handles



NPT	Stainless Steel Handle
1/2"	09-2A013-SS-12*
3/4"	09-2A013-SS-34

Notes: * For 1/2" NPT size, a hole size reducer is utilized.

Angles



Stainless Steel 30° Angle
09-2A027-SS

Junction Boxes



NPT	Stainless Steel Box with Stainless Steel Angle
3/4"	09-2A053-080-SS-34
1"	09-2A053-080-SS-1

Notes: • Includes angle adapter as shown.

Miscellaneous Accessories



Multi-Contact Removal Tool	Crimper Tool (Greenlee or equal)	European Crimping Tool
9-LD12-37	4CN30	61-CA500

NPT Guidelines

Cable Range	NPT
.312 - .625	1/2"
.438 - .812	3/4"
.660 - 1.000	1"

NPT sizes are determined by the cable diameter and third party cord grip.

Order Example

A typical order should include an inlet part number, a receptacle part number **AND** the matching handles, angles or other required accessories.



Male Inlet with Handle (Plug)
07-A8001-SS + 09-2A013-SS-34



Female Receptacle with Angle Adapter
07-A4001-SS + 09-2A027-SS

DSN24c
DS24c



DSN24c Multipin – 7.5A Plugs & Receptacles

Ratings

- Voltage**
DSN24c
50 VAC or 480 VAC Max/130 VDC*
* For DC order 480V model
DS24c
Up to 250 VAC Max/130 VDC
- Amperage Rating**
2A Current Interrupting
7.5A Non-Current Interrupting
! DSN24c/DS24c is capable of handling 4-20mA low current applications
- Environmental Ratings**
IP66/IP67
- Temperature Range**
Min -40°F/Max 140°F
See pg 234 for temps below -15°F.
- Wiring Capacity**
Min 18 AWG Max 14 AWG
- Applicable Standards**
UL Coming Soon!

For DSN24c dimensions, see pgs 35-36

Highlighted Feature

- Crimped Contacts**
DSN24c and DS24c devices now feature contacts that can be crimped or soldered. Each device is supplied with 2 bags of 13 contacts so that the product can be set up to suit application needs.

Receptacle (female)

Inlet (male)



Don't forget to add installation accessories to your order



North American Configurations

Voltage	Polarity	DSN24c Part # Poly	DS24c Part # Stainless Steel	Voltage	Polarity	DSN24c Part # Poly	DS24c Part # Stainless Steel
50V	24P*	63-B4002	37-B4002-SS	50V	24P*	63-B8002	37-B8002-SS
250V	23P+G*	-	37-B4002-SS	250V	23P+G*	-	37-B8002-SS
480V	23P+G*	63-B4002	-	480V	23P+G*	63-B8002	-

* 24P for devices up to 50V or 23P+G for devices up to 480V. Multiple voltage labels are provided for application in the field.

For international configurations and ratings (IEC,CE) visit meltric.com/international-catalog or contact customer service at 800.433.7642.

Simple Assembly and Disassembly

DSN37c shown



Assembly

To insert contacts when they have been wired is simple. Push wired contact into rear of insulator until it stops to complete the installation.



Disassembly

To remove, use the tool provided. Push tool from front onto contact until tool stops. Contact is then released at rear of insulator.

Main Options



Padlock Pawl



Mushroom Pawl



Self-Ejecting Devices*

* Requires straight insertion receptacle or inlet and self-ejecting plug or connector

Receptacle Options

Part

Straight Insertion	Recept # - 352
Self-Ejecting Connector Release	Recept # - 354
Mushroom Pawl	Recept # - 375
Padlock Pawl	Recept # - 843
Padlockable Mushroom Pawl	Recept # - 375- 843
Closed Lid Configuration	Recept # - NC



See pgs 211-220 for detailed information on these options

Inlet Options

Part

Self-Ejecting Plug Release	Inlet # - 338
----------------------------	---------------

Poly Devices Only

DSN24c Order Example:

To order a device with a Mushroom Pawl add **-375** to the receptacle part number.

DSN24c 22P = 63-B4002-**375**

Installation Accessories

Stainless Steel accessories are for Stainless Steel devices only.

Handles



NPT	Poly Handle	Stainless Steel Handle
1/2"	61-3A013-12	-
3/4"	61-3A013-34	1H34SS
1"	61-3A013-1	1H1SS
1 1/4"	61-3A013-114	-

Cable Range	Poly Handle w/Clamp & Bushing	Nylon Handle
.20 - .83	-	61-3A013
.750 - .875	1PM514	-
.875 - 1.000	1PM516	-
1.000 - 1.125	1PM518	-
1.125 - 1.250	1PM520	-
1.250 - 1.375	1PM522	-

NPT Guidelines

Cable Range	NPT
.312 - .625	1/2"
.438 - .812	3/4"
.660 - 1.000	1"
.875 - 1.375	1 1/4"

NPT sizes are determined by the cable diameter and third party cord grip.

- Notes:**
- Finger draw plates are recommended for easier connector closure on cord to cord assemblies.
 - For available cord grips see pgs 169-170.

Angles



Nylon 30° Angle	Metal 30° Angle	Metal Angle FS/FD Box 30°	Metal Straight Adapter	Stainless Steel 30° Angle
61-3A027	MA2	MAFS2*	MS2	MA2SS

* MAFS2 base measures approximately 4.2" x 2.7". Due to the variation in sizes of FS boxes, please verify that your FS box matches our dimensions, if not call Customer Service for other solutions.

Junction Boxes



30.2 in³⁺



51.3 in³⁺



8.5 in³⁺



85.0 in³⁺

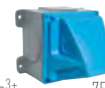

75.0 in³⁺



NPT	Metal Box	Metal Box with Nylon Angle	Stainless Steel Box*** w/Stainless Steel Angle	Poly* Conduit Entry	Poly 70°** Wall Box	Poly 70° Alum Wall Box	Stainless Steel Box
1/2"	MB312	61-3A053-080-12	-	61-3A023-12	51-BA058	59-BA058-12	-
3/4"	MB334	61-3A053-080-34	-	61-3A023-34	51-BA058	59-BA058-34	-
1"	MB31	61-3A053-080-1	39-1A053-080-SS-1	-	51-BA058	59-BA058-1	MB31SS
1 1/4"	MB3114	61-3A053-080-114	-	-	51-BA058	59-BA058-114	-
1 1/2"	-	-	-	-	-	59-BA058-112	-

- * For poly devices only.
** 70° boxes are not drilled. Contact customer service if factory drilling is required.

- *** Includes angle adapter as shown.
+ Interior volume with receptacle installed.

Miscellaneous Accessories



* Set of Two (2)



For Male Devices Only



For Male Devices Only



Receptacle⁺ Lockout Pin



Multi-Contact Removal Tool



Crimper Tool (Greenlee or equal)



European Crimping Tool

61-3A346	61-3A426	61-3A826	LP-843	9-LD12-37	4CN30	61-CA500
----------	----------	----------	--------	-----------	-------	----------

- * Recommended for cord to cord assembly applications, for easier connector closure.
+ Requires Padlockable Pawl option (-843) on receptacle.

**DSN37c
DS37c**



DSN37c Multipin – 7.5A Plugs & Receptacles

Ratings

- **Voltage**
Up to 480 VAC Max/130 VDC
- **Amperage Rating**
2A Current Interrupting
7.5A Non-Current Interrupting
! DSN37c/DS37c is capable of handling 4-20mA low current applications
- **Environmental Ratings**
IP66/IP67
- **Temperature Range**
Min -40°F/Max 140°F
See pg 234 for temps below -15°F.
- **Wiring Capacity**
Min 18 AWG Max 14 AWG
- **Applicable Standards**
UL Coming Soon!

For DSN37c dimensions, see pgs 35-36

Highlighted Feature

- **Crimped Contacts**
DSN37c devices now feature contacts that can be crimped or soldered. Each device is supplied with 3 bags of 13 contacts so that the product can be set up to suit application needs.

Receptacle (female)

Inlet (male)



Don't forget to add installation accessories to your order



North American Configurations

Voltage	Polarity	DSN37c Part # Poly	DS37c Part # Stainless Steel	Voltage	Polarity	DSN37c Part # Poly	DS37c Part # Stainless Steel
50V	37P*	63-C4003	37-C4003-SS	50V	37P*	63-C8003	37-C8003-SS
480V	36P+G*	63-C4003	37-C4003-SS	480V	36P+G*	63-C8003	37-C8003-SS

* 37P for devices up to 50V or 36P+G for devices up to 480V. Multiple voltage labels are provided for application in the field.

For international configurations and ratings (IEC,CE) visit meltric.com/international-catalog or contact customer service at 800.433.7642.

Simple Assembly and Disassembly



Assembly

To insert contacts when they have been wired is simple. Push wired contact into rear of insulator until it stops to complete the installation.



Disassembly

To remove, use the tool provided. Push tool from front onto contact until tool stops. Contact is then released at rear of insulator.

Main Options



Padlock Pawl



Mushroom Pawl



Self-Ejecting Devices*

* Requires straight insertion receptacle or inlet and self-ejecting plug or connector

Receptacle Options

Part

Straight Insertion	Recept # - 352
Self-Ejecting Connector Release	Recept # - 354
Mushroom Pawl	Recept # - 375
Padlock Pawl	Recept # - 843
Padlockable Mushroom Pawl	Recept # - 375- 843
Closed Lid Configuration	Recept # - NC



See pgs 211-220 for detailed information on these options

Inlet Options

Part

Self-Ejecting Plug Release	Inlet # - 338
----------------------------	---------------

Poly Devices Only

DSN37c Order Example:

To order a device with a Mushroom Pawl add **-375** to the receptacle part number.

DSN37c 32P = 63-C4003-375

Installation Accessories

Handles



Makes connector closures easier

NPT	Poly Handle	Stainless Steel Handle
1/2"	61-6A013-12	
3/4"	61-6A013-34	3H34SS
1"	61-6A013-1	3H1SS
1 1/4"	61-6A013-114	3H114SS

Cable Range	Poly Handle w/Clamp & Bushing	Nylon Handle	Poly Handle w/built in Draw Grips
.32 - 1.25	-	-	61-6A473
.39 - 1.18	-	61-6A013	-
.750 - .875	3PM514	-	-
.875 - 1.000	3PM516	-	-
1.000 - 1.125	3PM518	-	-
1.125 - 1.250	3PM520	-	-
1.250 - 1.375	3PM522	-	-

- Notes:**
- Finger draw plates are recommended for easier connector closure on cord to cord assemblies.
 - For available cord grips see pgs 169-170.

Angles

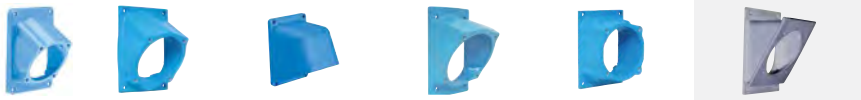

Nylon 30° Angle	Metal 30° Angle	Metal 70° Angle	Metal Angle FS/FD Box 30°	Metal Straight Adapter	Stainless Steel 30° Angle
61-6A027	MA3	89-3A027	MAFS3*	MS3	MA3SS

* MAFS3 base measures approximately 4.2" x 2.7". Due to the variation in sizes of FS boxes, please verify that your FS box matches our dimensions, if not call Customer Service for other solutions.

NPT Guidelines

Cable Range	NPT
.312 - .625	1/2"
.438 - .812	3/4"
.660 - 1.000	1"
.875 - 1.375	1 1/4"

NPT sizes are determined by the cable diameter and third party cord grip.

Junction Boxes



NPT	Metal Box	Metal Box with Nylon Angle	Stainless Steel Box*** w/Stainless Steel Angle	Poly* Conduit Entry	Poly 70°*** Wall Box	Poly 70° Alum Wall Box	Stainless Steel Box
1/2"	MB312	61-6A053-080-12	-	61-6A023-12	51-CA058	59-CA058-12	-
3/4"	MB334	61-6A053-080-34	-	61-6A023-34	51-CA058	59-CA058-34	-
1"	MB31	61-6A053-080-1	39-3A053-080-SS-1	61-6A023-1	51-CA058	59-CA058-1	MB31SS
1 1/4"	MB3114	61-6A053-080-114	-	-	51-CA058	59-CA058-114	-
1 1/2"	-	-	-	-	-	59-CA058-112	-

- * For poly devices only.
** 70° boxes are not drilled. Contact customer service if factory drilling is required.

- *** Includes angle adapter as shown.
+ Interior volume with receptacle installed.

Miscellaneous Accessories

Finger Drawplates	Protective Cap	Padlockable Plug Cap	Receptacle+ Lockout Pin	Multi-Contact Removal Tool	Crimper Tool (Greenlee or equal)	European Crimping Tool
61-6A346	61-6A426	61-6A826	LP-843	9-LD12-37	4CN30	61-CA500

- * Recommended for cord to cord assembly applications, for easier connector closure.
+ Requires Padlockable Pawl option [-843] on receptacle.

DN9c



DN9c Multipin – 20A Plugs & Receptacles

Ratings

- Voltage**
50 VAC or 480 VAC Max / 130 VDC+
* For DC order 480V model.
Not CSA listed.
- Amperage Rating**
20A Current Interrupting
- Horsepower Ratings**

120V	1Ø	1/3 hp
240V	1Ø	1 hp
208V	3Ø	2 hp
240V	3Ø	3 hp
480V	3Ø	5 hp
- Environmental Ratings**
IP54/IP55
- Temperature Range**
Min -40°F / Max 140°F
See pg 234 for temps below -15°F.
- Wiring Capacity**
Min 16 AWG Max 10 AWG
- Applicable Standards**
CSA 182.01

For DN9c dimensions, see pgs 91-92

Receptacle (female)



Don't forget to add installation accessories to your order



Inlet (male)



North American Configurations

Voltage	Polarity	Part # Metal
50V	6P	17-14060
50V	7P	17-14070
50V	8P	17-14080
50V	9P	17-14090
480V	5P+G	17-14051
480V	6P+G	17-14061
480V	7P+G	17-14071
480V	8P+G	17-14081

Voltage	Polarity	Part # Metal
50V	6P	17-18060
50V	7P	17-18070
50V	8P	17-18080
50V	9P	17-18090
480V	5P+G	17-18051
480V	6P+G	17-18061
480V	7P+G	17-18071
480V	8P+G	17-18081

For international configurations and ratings (IEC,CE) visit meltric.com/international-catalog or contact customer service at 800.433.7642.

Main Options

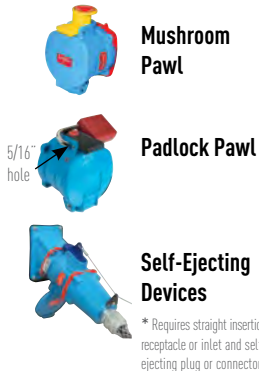

Mushroom Pawl

Padlock Pawl

Self-Ejecting Devices

* Requires straight insertion receptacle or inlet and self-ejecting plug or connector

Receptacle Options

Part

Straight Insertion	Recept # - A188
Self-Ejecting Connector Release	Recept # - 348-A188
HP Watertightness (high pressure)	Recept # - HP
Mushroom Pawl	Recept # - 375
Locking Mushroom Pawl	Recept # - 845
Padlock Pawl	Recept # - 843
Padlockable Mushroom Pawl	Recept # - 375- 843
Closed Lid Configuration	Recept # - NC

Inlet Options

Part

Self-Ejecting Plug Release	Inlet # - 338-A188
Straight Insertion	Inlet # - A188

DN9c Order Example:

To order Closed Lid Configuration on a receptacle add **-NC** to the part numbers.

DN9c Receptacle 9P=17-14090-**NC**

Appropriate accessory part numbers must also be included on the order.



See pgs 211-220 for detailed information on these options

Installation Accessories

Handles



Not Type 3R

Makes connector closures easier

NPT	Poly Handle	Metal Handle
1/2"	3PH12	3H12
3/4"	3PH34	3H34
1"	3PH1	3H1
1 1/4"	3PH114	3H114

Cable Range	Nylon Handle	Neoprene Handle	Poly Handle w/Clamp & Bushing	Poly Handle w/built in Draw Grips
.32 - 1.25	-	-	-	FH311-473
.38 - 1.12	-	31-311	-	-
.39 - 1.18	FH311	-	-	-
.750 - .875	-	-	3PM514	-
.875 - 1.000	-	-	3PM516	-
1.000 - 1.125	-	-	3PM518	-
1.125 - 1.250	-	-	3PM520	-
1.250 - 1.375	-	-	3PM522	-

- Notes:**
- Finger draw plates are recommended for easier connector closure on cord to cord assemblies.
 - For available cord grips, see pgs 169-170.

Angles



Metal 30° Angle	Metal 70° Angle	Metal Angle FS/FD Box 30°	Metal Straight Adapter
MA3	89-3A027	MAFS3*	MS3

* MAFS3 base measures approximately 4.2" x 2.7". Due to the variation in sizes of FS boxes, please verify that your FS box matches our dimensions, if not call Customer Service for other solutions.

NPT Guidelines

Cable Range	NPT
.312 - .625	1/2"
.438 - .812	3/4"
.660 - 1.000	1"
.875 - 1.375	1 1/4"

NPT sizes are determined by the cable diameter and third party cord grip.

Accessory Spotlight

Receptacle Locking Pin



A 5/16" locking pin can be ordered to securely lockout receptacles that include the 'padlockable pawl' option. The user can also utilize a lock with a 5/16" shank. Locks with smaller shanks will NOT securely lockout a receptacle pawl.

Junction Boxes

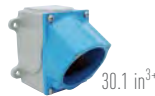

30.1 in³⁺

NPT	Metal Box	Metal Box Metal Angle 30°
1/2"	MB312	39-3A053-080-12
3/4"	MB334	39-3A053-080-34
1"	MB31	39-3A053-080-1
1 1/4"	MB3114	39-3A053-080-114

+ Interior volume with receptacle installed.

Miscellaneous Accessories



* Set of Two (2)



For Male Devices Only



Finger Drawplates	Protective Neoprene Cap	Cord Grip with Mesh	Receptacle ⁺ Lockout Pin
FDP3	DN16R	see pgs 169-170	LP-843

- * Recommended for cord to cord assembly applications, for easier connector closure.
 + Requires Padlockable Pawl option (-843) on receptacle.

Order Example

A typical order should include an inlet part number, a receptacle part number **AND** the matching handles, angles or other required accessories.



Male Inlet with Handle (Plug)
17-18060 + FH311



Female Receptacle with Angle Adapter
17-14060 + MA3

DN20c



DN20c Multipin – 20A Plugs & Receptacles

Ratings

- Voltage**
50 VAC or 480 VAC Max/130 VDC*
* For DC order 480V model.
Not CSA listed.
- Amperage Rating**
20A/15A Current Interrupting*
* The amperage rating is 15A when more than 12 contacts are used for power circuits (not control).
- Horsepower Ratings**

120V	1Ø	1/6 hp
240V	1Ø	1/2 hp
208V	3Ø	1 hp
240V	3Ø	1 hp
480V	3Ø	3 hp
- Environmental Ratings**
IP54/IP55
- Temperature Range**
Min -40°F/Max 140°F
See pg 234 for temps below -15°F.
- Wiring Capacity**
Min 16 AWG Max 10 AWG
- Applicable Standards**
CSA 182.01

For DN20c dimensions, see pgs 91-92

Receptacle (female)



Don't forget to add installation accessories to your order

Inlet (male)



* The amperage rating is 15A when more than 12 contacts are used for power circuits (not control).

North American Configurations

Voltage	Polarity	Part # Metal	Voltage	Polarity	Part # Metal
50V	10P	17-64100	50V	10P	17-68100
50V	11P	17-64110	50V	11P	17-68110
50V	12P	17-64120	50V	12P	17-68120
50V	13P	17-64130*	50V	13P	17-68130*
50V	14P	17-64140*	50V	14P	17-68140*
50V	15P	17-64150*	50V	15P	17-68150*
50V	16P	17-64160*	50V	16P	17-68160*
50V	17P	17-64170*	50V	17P	17-68170*
50V	18P	17-64180*	50V	18P	17-68180*
50V	19P	17-64190*	50V	19P	17-68190*
50V	20P	17-64200*	50V	20P	17-68200*
480V	9P+G	17-64091	480V	9P+G	17-68091
480V	10P+G	17-64101	480V	10P+G	17-68101
480V	11P+G	17-64111	480V	11P+G	17-68111
480V	12P+G	17-64121	480V	12P+G	17-68121
480V	13P+G	17-64131*	480V	13P+G	17-68131*
480V	14P+G	17-64141*	480V	14P+G	17-68141*
480V	15P+G	17-64151*	480V	15P+G	17-68151*
480V	16P+G	17-64161*	480V	16P+G	17-68161*
480V	17P+G	17-64171*	480V	17P+G	17-68171*
480V	18P+G	17-64181*	480V	18P+G	17-68181*
480V	19P+G	17-64191*	480V	19P+G	17-68191*

For international configurations and ratings (IEC,CE) visit meltric.com/international-catalog or contact customer service at 800.433.7642.

Main Options



Mushroom Pawl



Self-Ejecting Devices

* Requires straight insertion receptacle or inlet and self-ejecting plug or connector



See pgs 211-220 for detailed information on these options

Receptacle Options

Part

Straight Insertion	Recept # - A188
Self-Ejecting Connector Release	Recept # - 348-A188
HP Watertightness (high pressure)	Recept # - HP
Mushroom Pawl	Recept # - 375
Locking Mushroom Pawl	Recept # - 845
Padlock Pawl	Recept # - 843
Padlockable Mushroom Pawl	Recept # - 375-843
180° Opening Lid	Recept # - 180
Closed Lid Configuration	Recept # - NC

Inlet Options

Part

Self-Ejecting Plug Release	Inlet # - 338-A188
Straight Insertion	Inlet # - A188

DN20c Order Example:

To order Closed Lid Configuration on a receptacle add **-NC** to the receptacle part numbers.

DN20c Receptacle 19P=17-64190-**NC**

Appropriate accessory part numbers must also be included on the order.

Installation Accessories

Handles



NPT	Poly Handle	Metal Handle
3/4"	9PH34	9H34
1"	9PH1	9H1
1 1/4"	9PH114	9H114
1 1/2"	9PH112	9H112
2"	9PH2	9H2

Cable Range	Santoprene™ Handle	Poly Handle w/Clamp & Bushing
.70 - 1.00	65-9A013-D25	-
1.00 - 1.375	65-9A013-D35	-
1.250 - 1.375	-	9PM622
1.375 - 1.750	65-9A013-D45	-
1.438 - 1.562	-	9PM625
1.562 - 1.688	-	9PM627
1.688 - 1.812	-	9PM629

Notes: • For available cord grips, see pgs 169-170.

Angles



Metal 30° Angle	Metal 70° Angle	Metal Straight Adapter
MA10	89-9A027	MS10

Junction Boxes



NPT	Metal Box	Metal Box Metal Angle 30°
1 1/4"	MB10114	39-9A053-080-114
1 1/2"	MB10112	39-9A053-080-112
2"	MB102	39-9A053-080-2
2 1/2"	MB10212	39-9A053-080-212

NPT Guidelines

Cable Range	NPT
.312 - .625	1/2"
.438 - .812	3/4"
.660 - 1.000	1"
.875 - 1.375	1 1/4"
.890 - 1.812	1 1/2"
1.190 - 2.438	2"
2.062 - 2.438	2 1/2"

NPT sizes are determined by the cable diameter and third party cord grip.

Miscellaneous Accessories



For Male Devices Only



Protective Neoprene Cap	Cord Grip with Mesh	Receptacle ⁺ Lockout Pin
DN63R	see pgs 169-170	LP-843

⁺ Requires Padlockable Pawl option (-843) on receptacle.

Order Example

A typical order should include an inlet part number, a receptacle part number **AND** the matching handles, angles or other required accessories.



Male Inlet with Handle (Plug)
17-68200 + 65-9A013-D25



Female Receptacle with Angle Adapter
17-64200 + MA10

DS7c



DS7c Multipin – 30A Plugs & Receptacles

Ratings

- **Voltage**
50 VAC or 600 VAC Max/130 VDC+
+ For DC order 600V model
- **Amperage Rating**
30A Current Interrupting
- **Temperature Range**
Min -40°F/Max 140°F
See pg 234 for temps below -15°F.
- **Environmental Ratings**
IP54/IP55
- **Wiring Capacity**
Min 14 AWG Max 8 AWG
- **Applicable Standards**
Contact Customer Service

For DS7c dimensions, see pgs 53-54

Receptacle (female)



Don't forget to add installation accessories to your order

Inlet (male)



North American Configurations

Voltage	Polarity	Part #	
		Poly	Metal
50V	4P	33-34540	37-34540
50V	5P	33-34550	37-34550
50V	6P	33-34560	37-34560
50V	7P	33-34570	37-34570
600V	3P+G	33-34531	37-34531
600V	4P+G	33-34541	37-34541
600V	5P+G	33-34551	37-34551
600V	6P+G	33-34561	37-34561

Voltage	Polarity	Part #	
		Poly	Metal
50V	4P	33-38540	37-38540
50V	5P	33-38550	37-38550
50V	6P	33-38560	37-38560
50V	7P	33-38570	37-38570
600V	3P+G	33-38531	37-38531
600V	4P+G	33-38541	37-38541
600V	5P+G	33-38551	37-38551
600V	6P+G	33-38561	37-38561

For international configurations and ratings (IEC,CE) visit meltric.com/international-catalog or contact customer service at 800.433.7642.

Main Options



Padlock Pawl



Mushroom Pawl



Self-Ejecting Devices

* Requires straight insertion receptacle or inlet and self-ejecting plug or connector

Receptacle Options

Part

With 2 Auxiliary/Pilot contacts	Recept # - 172
With 3 Auxiliary/Pilot contacts	Recept # - 173
Type 4X & closed lid configuration	Recept # - 4X
Straight Insertion	Recept # - 352
Self-Ejecting Connector Release	Recept # - 354
Mushroom Pawl	Recept # - 375
Locking Mushroom Pawl	Recept # - 845
Padlock Pawl	Recept # - 843
Padlockable Mushroom Pawl	Recept # - 375- 843
Metal Pawl (on poly receptacle)	Recept # - 824
Closed Lid Configuration	Recept # - NC

Inlet Options

Part

With 2 Auxiliary/Pilot Contacts	Inlet # - 172
With 3 Auxiliary/Pilot Contacts	Inlet # - 173
Type 4X Watertightness	Inlet # - 4X
Self-Ejecting Plug Release	Inlet # - 338
With No Lockout Hole	Inlet # - A155



See pgs 211-220 for detailed information on these options

DS7c Order Example:

To order a device with a Mushroom Pawl, add **-375** to the receptacle part number.
DS7c 4P = 33-34540-375

Installation Accessories

Unless indicated otherwise, accessories can be used with either poly or metal plugs and receptacles.

Handles



Not Type 3R



Makes connector closures easier

NPT	Poly Handle	Metal* Handle	Cable Range	Nylon Handle	Neoprene Handle	Poly Handle w/Clamp & Bushing	Poly Handle w/built in Draw Grips
1/2"	6PH12	6H12	.50 - 1.25	-	31-611	-	-
3/4"	6PH34	6H34	.51 - 1.38	FH611	-	-	FH611-473
1"	6PH1	6H1	1.250 - 1.375	-	-	6PM622	-
1 1/4"	6PH114	6H114	1.438 - 1.562	-	-	6PM625	-
1 1/2"	6PH112	6H112	1.562 - 1.688	-	-	6PM627	-
			1.688 - 1.812	-	-	6PM629	-

- Notes:**
- Finger draw plates are recommended for easier connector closure on cord to cord assemblies.
 - For available cord grips, see pgs 169-170.
 - * For metal devices only.

Angles



Nylon 30° Angle	Metal 30° Angle	Metal 70° Angle	Metal Angle+ Oversized 30°	Metal Straight Adapter	Metal Lateral Angle 30°
MP6	MA6	89-6A027	MA660	MS6	MAB6

+ Mounts on oversize box only. Order with MB10xxx box. See page 48.

Junction Boxes



61.4 in³⁺

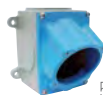

59.9 in³⁺



28.1 in³⁺



184.0 in³⁺

NPT	Metal Box	Metal Box with Nylon Angle	Metal Box with Metal Angle	Poly* Conduit Entry	Poly 70°** Wall Box
1/2"	-	-	-	MC612	51-DA058
3/4"	-	-	-	MC634	51-DA058
1"	MB61	31-6A053-080-1	39-6A053-080-1	MC61	51-DA058
1 1/4"	MB6114	31-6A053-080-114	39-6A053-080-114	MC6114	51-DA058
1 1/2"	MB6112	31-6A053-080-112	39-6A053-080-112	-	51-DA058
2"	MB62	31-6A053-080-2	39-6A053-080-2	-	51-DA058

- * For poly devices only
 ** 70° boxes are not drilled. Contact customer service if factory drilling is required.
 + Interior volume with receptacle installed.

Miscellaneous Accessories



* Set of Two (2)



For Male Devices Only



For Male Devices Only



Finger Drawplates	Protective Cap	Padlockable Cap Aluminum	Inlet Spring-Loaded cap	Receptacle+ Lockout Pin
FDP6	31-6A426	DS6MC	31-6A226	LP-843

- * Recommended for cord to cord assembly applications, for easier connector closure.
 + Requires Padlockable Pawl option (-843) on receptacle.

NPT Guidelines

Cable Range	NPT
.312 - .625	1/2"
.438 - .812	3/4"
.660 - 1.000	1"
.875 - 1.375	1 1/4"
.890 - 1.812	1 1/2"

NPT sizes are determined by the cable diameter and third party cord grip.

Order Example

A typical order should include an inlet part number, a receptacle part number **AND** the matching handles, angles or other required accessories.



Male Inlet with Handle (Plug)
33-38540 + FH611



Female Receptacle with Angle Adapter
33-34540 + MP6

DR7c



DR7c Multipin – 50A Plugs & Receptacles

Ratings

- **Voltage**
50 VAC or 600 VAC Max/130 VDC+
+ For DC order 600V model
- **Amperage Rating**
50A Non-Current Interrupting
- **Temperature Range**
Min -40°F/Max 140°F
See pg 234 for temps below -15°F.
- **Environmental Ratings**
IP54/IP55
- **Wiring Capacity**
Min 14 AWG Max 8 AWG
- **Applicable Standards**
Contact Customer Service

For DR7c dimensions, see pgs 53-54

Receptacle (female)



Don't forget to add installation accessories to your order

Inlet (male)



North American Configurations

Voltage	Polarity	Part #	
		Poly	Metal
50V	4P	31-34940	39-34940
50V	5P	31-34950	39-34950
50V	6P	31-34960	39-34960
50V	7P	31-34970	39-34970
600V	3P+G	31-34931	39-34931
600V	4P+G	31-34941	39-34941
600V	5P+G	31-34951	39-34951
600V	6P+G	31-34961	39-34961

Voltage	Polarity	Part #	
		Poly	Metal
50V	4P	31-38940	39-38940
50V	5P	31-38950	39-38950
50V	6P	31-38960	39-38960
50V	7P	31-38970	39-38970
600V	3P+G	31-38931	39-38931
600V	4P+G	31-38941	39-38941
600V	5P+G	31-38951	39-38951
600V	6P+G	31-38961	39-38961

For international configurations and ratings (IEC,CE) visit meltric.com/international-catalog or contact customer service at 800.433.7642.

Main Options



Padlock Pawl



Mushroom Pawl



Self-Ejecting Devices

* Requires straight insertion receptacle or inlet and self-ejecting plug or connector

Receptacle Options

Part

With 2 Auxiliary/Pilot contacts	Recept # - 172
With 3 Auxiliary/Pilot contacts	Recept # - 173
Type 4X & closed lid configuration	Recept # - 4X
Straight Insertion	Recept # - 352
Self-Ejecting Connector Release	Recept # - 354
Mushroom Pawl	Recept # - 375
Locking Mushroom Pawl	Recept # - 845
Padlock Pawl	Recept # - 843
Padlockable Mushroom Pawl	Recept # - 375- 843
Metal Pawl (on poly receptacle)	Recept # - 824
Closed Lid Configuration	Recept # - NC

Inlet Options

Part

With 2 Auxiliary/Pilot contacts	Inlet # - 172
With 3 Auxiliary/Pilot contacts	Inlet # - 173
Type 4X Watertightness	Inlet # - 4X
Self-Ejecting Plug Release	Inlet # - 338
With No Lockout Hole	Inlet # - A155

DR7c Order Example:

To order a device with a Mushroom Pawl add **-375** to the receptacle part number.
DR7c 4P = 31-34940-375



See pgs 211-220 for detailed information on these options

Installation Accessories

Unless indicated otherwise, accessories can be used with either poly or metal plugs and receptacles

Handles



Not Type 3R

Makes connector closures easier

NPT	Poly Handle	Metal* Handle	Cable Range	Nylon Handle	Neoprene Handle	Poly Handle w/Clamp & Bushing	Poly Handle w/built in Draw Grips
1/2"	6PH12	6H12	.50 - 1.25	-	31-611	-	-
3/4"	6PH34	6H34	.51 - 1.38	FH611	-	-	FH611-473
1"	6PH1	6H1	1.250 - 1.375	-	-	6PM622	-
1 1/4"	6PH114	6H114	1.438 - 1.562	-	-	6PM625	-
1 1/2"	6PH112	6H112	1.562 - 1.688	-	-	6PM627	-
			1.688 - 1.812	-	-	6PM629	-

- Notes:**
- Finger draw plates are recommended for easier connector closure on cord to cord assemblies.
 - For available cord grips, see pgs 169-170.
 - * For metal devices only.

Angles



Nylon 30° Angle	Metal 30° Angle	Metal 70° Angle	Metal Angle+ Oversized 30°	Metal Straight Adapter	Metal Lateral Angle 30°
MP6	MA6	89-6A027	MA660	MS6	MAB6

+ Mounts on oversize box only. Order with MB10xxx box. See page 48.

Junction Boxes

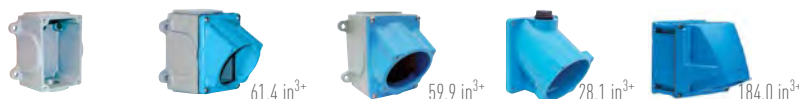

NPT	Metal Box	Metal Box with Nylon Angle	Metal Box with Metal Angle	Poly* Conduit Entry	Poly 70°** Wall Box
1/2"	-	-	-	MC612	51-DA058
3/4"	-	-	-	MC634	51-DA058
1"	MB61	31-6A053-080-1	39-6A053-080-1	MC61	51-DA058
1 1/4"	MB6114	31-6A053-080-114	39-6A053-080-114	MC6114	51-DA058
1 1/2"	MB6112	31-6A053-080-112	39-6A053-080-112	-	51-DA058
2"	MB62	31-6A053-080-2	39-6A053-080-2	-	51-DA058

- * For poly devices only
 ** 70° boxes are not drilled. Contact customer service if factory drilling is required.
 + Interior volume with receptacle installed.

Miscellaneous Accessories



* Set of Two (2) For Male Devices Only For Male Devices Only

Finger Drawplates	Protective Cap	Padlockable Cap Aluminum	Inlet Spring-Loaded cap	Receptacle + Lockout Pin
FDP6	31-6A426	DS6MC	31-6A226	LP-843

- * Recommended for cord to cord assembly applications, for easier connector closure.
 + Requires Padlockable Pawl option (-843) on receptacle.

NPT Guidelines

Cable Range	NPT
.312 - .625	1/2"
.438 - .812	3/4"
.660 - 1.000	1"
.875 - 1.375	1 1/4"
.890 - 1.812	1 1/2"

NPT sizes are determined by the cable diameter and third party cord grip.

Order Example

A typical order should include an inlet part number, a receptacle part number **AND** the matching handles, angles or other required accessories.



Male Inlet with Handle (Plug)
31-38940 + FH611



Female Receptacle with Angle Adapter
31-34940 + MP6



Spare Parts Male Configuration

PN7c pictured



DN9c pictured



PN7c	POLY	METAL
Plug Interior, Ground Contact & Connection	01-PA910	09-PA910
Plug Contact	09-PA911	09-PA911
Device Gasket	61-1AM26	61-1AM26
Plug Casing	01-NA014	09-NA014
Ground Contact	09-PA919	09-PA919

PN12c	POLY	METAL
Plug Interior	01-AA910	09-AA910
Plug Contact (Quantity = 13)*	01-AA113	01-AA113
Device Gasket	61-1AM26	61-1AM26
Plug Casing	01-NA014	09-NA014
Ground Contact (Quantity = 13)*	01-AA113	01-AA113

* If the PN12c device was purchased before March 2013, contact customer service for parts.

DSN24c / 37c	24 POLY	37 POLY
Plug Interior	61-BA910	61-CA910
Plug Contact (Quantity = 13)*	61-BA113	61-CA113
Plug Ground Contact (Quantity = 13)*	61-BA113	61-CA113
Plug Casing**	61-3A105	61-6A105
Device Gasket	61-3AM26	31-3AM26
Stainless Steel Casing	39-1A014-SS	39-3A014-SS

* If the DSN24c or 37c device was originally purchased before February 2013, contact customer service for parts.

** If the DSN24c or 37c was originally purchased before March 2015 contact customer service for casing parts.

DN9c / 20c	9 METAL	20 METAL
Plug Interior	19-1A910	19-6A910
Plug Contact (Short/Outside)	19-1A911	19-6A911
Plug Contact (Long/Inside)	19-1A711	19-6A711
Plug Ground Contact	19-1A919	19-6A919
Plug Casing	19-1A014	19-6A014
Device Gasket	31-3A026	31-9A026

DS7c / DR7c	POLY	METAL
Plug Casing	31-6A014	39-6A014
Plug Phase Contact	31-3A911	31-3A911
Plug Pilot Contact	31-3A911-172	31-3A911-172
Plug Interior	31-3A910-263	31-3A910-263
Device Gasket	31-6AM26	31-6AM26
Ground Contact	31-3A919	31-3A919

Spare Parts

Female Configuration

Multipin

PN7c pictured



DN9c pictured



PN7c	POLY	METAL
Receptacle Interior, Ground Contact & Connection	01-PA920	09-PA920
Receptacle Contact	09-PA921	09-PA921
Device Gasket	61-1AM26	61-1AM26
Receptacle Casing	01-NA024	09-NA024
Ground Contact	09-PA929	09-PA929

PN12c	POLY	METAL
Receptacle Interior*	01-AA920	09-AA920
Receptacle Contact (Quantity = 13)*	31-CA213	31-CA213
Device Gasket	61-1AM26	61-1AM26
Receptacle Casing	01-NA024	09-NA024
Ground Contact (Quantity = 13)*	31-CA213	31-CA213

* If the PN12c device was purchased before March 2013, contact customer service for parts.

DSN24c/37c	24 POLY	37 POLY
Receptacle Interior*	61-BA920	61-CA920
Receptacle Contact (Quantity = 13)*	61-BA213	61-CA213
Receptacle Ground Contact (Quantity = 13)*	61-BA213	61-CA213
Receptacle Casing**	61-3A305	61-6A305
Device Gasket	61-3AM26	31-3AM26
Stainless Steel Casing	39-1A024-SS	39-3A024-SS

* If the DSN24c or 37c device was originally purchased before February 2013, contact customer service for parts.

** If the DSN24c or 37c was originally purchased before March 2015 contact customer service for casing parts.

DN9c/20c	9 METAL	20 METAL
Receptacle Interior	19-1A920	19-6A920
Receptacle Contact (Short/Outside)	19-1A921	19-6A921
Receptacle Contact (Long/Inside)	19-1A721	19-6A721
Receptacle Ground Contact	19-1A929	19-6A929
Receptacle Casing	19-1A024	19-6A024
Lid, Gasket, Roll Pin & Spring	19-1A925	19-6A925
Device Gasket	31-3A026	31-9A026

DS7c/DR7c	POLY	METAL
Receptacle Casing	31-6A024	39-6A024
Receptacle Phase Contact	31-3A921	31-3A921
Receptacle Pilot Contact	31-3A921-172	31-3A921-172
Receptacle Interior	31-3A920-263	31-3A920-263
Device Gasket	31-6AM26	31-6AM26
Ground Contact	31-3A929	31-3A929

DN



Dimensions

Inlet – Provided in inches

Dimensions are for reference only and may change depending on accessories used. For precise dimensions contact MELTRIC Engineering.

plug

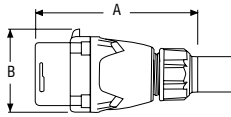

PRODUCT	A	B
DN9c	5.79	3.39
DN20c	10.75	4.92

inlet with connector inlet

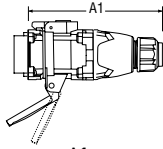

PRODUCT	A1
DN9c	6.85
DN20c	12.24

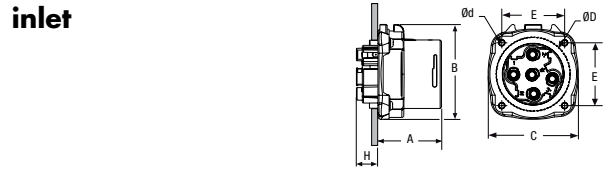

PRODUCT	A	C	E	H	Ød	ØD
DN9c	2.01	3.19	2.17	0.59	0.20	2.68
DN20c	3.50	4.65	3.19	0.98	0.24	3.94

30° inclined inlet/angle with connector

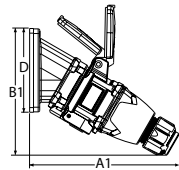

PRODUCT	A1	B1	D
DN9c	8.03	7.01	4.21
DN20c	12.72	10.04	5.51

30° inlet/angle

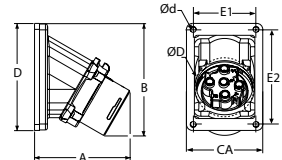

PRODUCT	A	B	CA	D	E1	E2	Ød	ØD
DN9c	3.86	4.65	2.99	4.21	2.48	3.74	0.22	2.36
DN20c	6.57	6.54	5.51	5.51	4.88	4.88	0.28	4.72

30° inclined inlet/angle/ junction box with connector

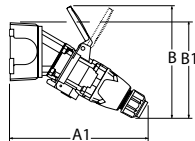

PRODUCT	A1	B	B1
DN9c	10.51	8.23	7.13
DN20	16.34	11.22	10.04

inlet/angle/ metal junction box

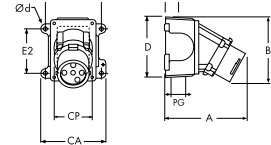

PRODUCT	A	B	CA	CP	D	E1	E2	H	PG	Ød
DN9c	6.34	4.40	4.25	3.03	4.57	3.75	2.78	1.18	1.00	0.25
DN20c	10.20	7.54	7.44	4.33	5.65	6.62	4.24	1.93	2.00	0.31



Dimensions

Receptacle – Provided in inches

Dimensions are for reference only and may change depending on accessories used. For precise dimensions contact MELTRIC Engineering.

connector

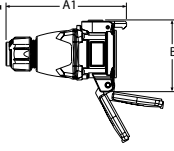

PRODUCT	A1	B
DN9c	6.65	3.86
DN20c	11.22	5.31

receptacle with plug

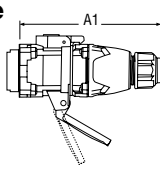

PRODUCT	A1
DN9c	6.85
DN20c	12.24

receptacle

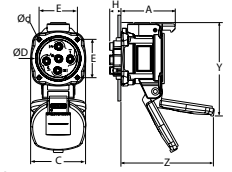

PRODUCT	A	C	E	H	Y	Z	Ød	ØD
DN9c	2.87	3.19	2.17	0.59	3.86	4.92	0.20	2.68
DN20c	4.33	4.65	3.19	0.94	5.20	7.68	0.24	3.94

30° inclined receptacle/angle with plug

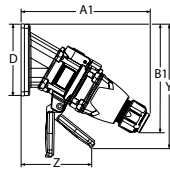

PRODUCT	A1	B1	D	Y	Z
DN9c	4.09	7.01	4.21	8.03	4.13
DN20c	13.78	10.43	5.51	10.75	7.17

30° receptacle/angle

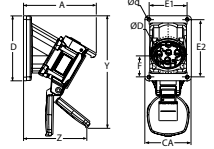

PRODUCT	A	CA	D	E1	E2	F	Y	Z	Ød	ØD
DN9c	5.00	2.99	4.21	2.48	3.74	1.57	8.03	4.13	0.22	2.36
DN20c	7.68	5.51	5.51	4.88	4.88	2.42	10.75	7.17	0.28	4.72

30° inclined receptacle/angle/junction box with plug

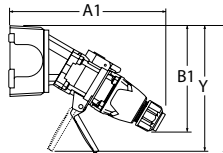

PRODUCT	A1	B1	Y
DN9c	6.57	7.13	8.15
DN20c	16.34	10.04	10.75

receptacle/angle/metal junction box

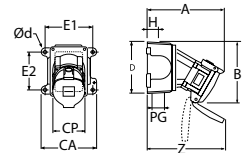

PRODUCT	A	B	CA	CP	D	E1	E2	H	PG	Y	Z	Ød
DN9c	7.48	6.89	4.40	2.91	4.57	4.19	2.78	1.18	1.00	8.15	6.61	0.25
DN20c	11.31	9.33	7.54	4.41	5.65	6.62	4.24	1.93	2.00	10.75	10.79	0.31

DR



Features and Ratings	p. 94
DR30	p. 95
DR50	p. 97
DR100	p. 99
DR150	p. 101
DR 250	p. 103
DR400	p. 105
Spare parts	p. 107
Dimensions	p. 109



Robust construction and high amperage capabilities

DR series plugs and receptacles provide safe, economical and robust connections for applications up to 400A. Some DR models are non-current interrupting rated, while others are suitable for current interruption on resistive loads (see table on next page). The DR's spring-loaded, silver-nickel butt contacts and dead front construction provide more consistent and reliable connections and significant improvements in operator safety compared to competitive devices.

Main Advantages

- ▶ High amperage capacity
- ▶ Up to 6 auxiliary contacts
- ▶ Robust Metal or Poly construction

Product Features

DSN pictured

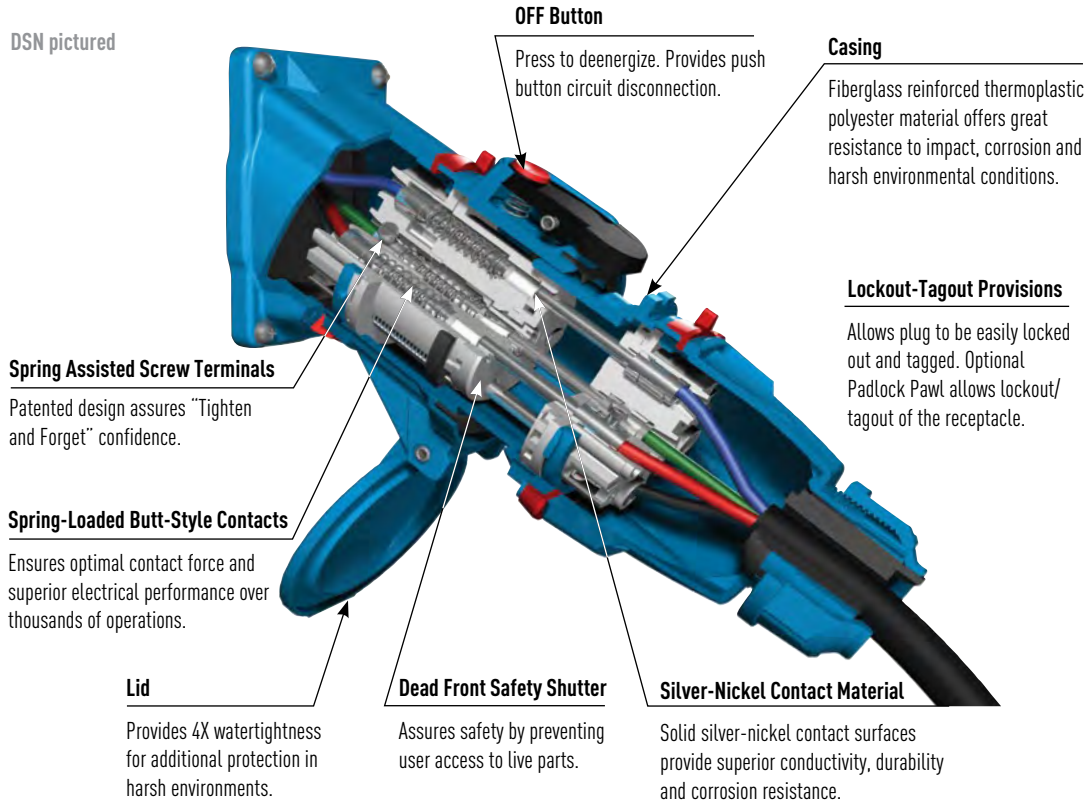

General Ratings

Amperage	30 to 400A
Voltage	600 VAC
Frequency	50-400 Hz
Short-Circuit (Withstand)	10kA to 100kA*
Environmental	Type 3R, IP54/IP55**
Temperature	min -40°F/max 140°F

* DR30, 50 and 100 are 100kA; DR150, 250, and 400 are 10kA to 65kA
Testing was performed with RK1 current limiting fuses sized at at least 100% of the devices ampacity ratings.

** IP54 rated when receptacle and plug are mated, when not mated receptacle alone is IP55 rated provided that the lid is latched closed.

Current Interruption Listings

Model	Current Interruption Capabilities
DR30	Not for current interrupting
DR50	For current interrupting up to 250 VAC***
DR100	For current interrupting up to 250 VAC***
DR150	For current interrupting up to 250 VAC***
DR250	Not for current interrupting
DR400	Not for current interrupting

*** Devices rated for current interrupting are not intended for repetitive switching duties.

Category	UL	CSA	IEC
Plugs and Receptacles	UL 1682	C22.2 No. 182.1	60309-1

CE ratings available upon request

Operating Instructions



When the plug and receptacle are latched together, the circuit is connected.



Pressing the pawl causes the DR to break the circuit. The plug is ejected to its rest position; its contacts are now dead.



Rotating the 'dead' plug 30° counterclockwise closes the safety shutter and frees the plug to be withdrawn from the receptacle.

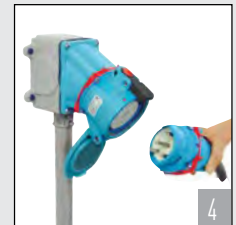

The plug and the receptacle are separated. The safety shutter prevents access to live parts.

5 To reconnect, insert plug into receptacle, twist slightly, and apply insertion force.

DR30



DR – 30A Standard Duty Plugs & Receptacles

UL/CSA Ratings

- **Max Amperage & Voltage**
30A, 600 VAC
- **Current Interruption Capability**
Not for current interrupting
For Switch-Rated devices, see DS & DSN sections.
- **Short Circuit Rating**
100kA
Testing was performed with RK1 current limiting fuses sized at at least 100% of the devices ampacity rating.
- **Environmental Ratings**
Type 3R, IP54/IP55*
* IP54 when the plug & receptacle are mated. IP55 on the receptacle alone when the lid is latched closed.
- **Temperature Range**
Min -40°F/Max 140°F
See pg 234 for temps below -15°F.
- **Wiring Capacity**
Min 14 AWG Max 8 AWG
Aux Contacts - Max 14 AWG
* Based on THHN wire sizes
- **Applicable Standards**
UL 1682, CSA 182.1

Receptacle (female)



Don't forget to add installation accessories to your order

Inlet (male)



North American UL/CSA Configurations

Voltage	Polarity	Part # Poly
120V	1P+N+G	31-14235-K16
120/208V	3P+N+G	31-14237-K16
125V	1P+N+G	31-14175-K07
125/250V	2P+N+G	31-14176-K07
208V	2P+G	31-14232-K16
208V	3P+G	31-14233-K16
250V	2P+G	31-14172-K07
250V	3P+G	31-14173-K07
277V	1P+N+G	31-14245-K04
277/480V	3P+N+G	31-14247-K04
347/600V	3P+N+G	31-14187-K14
480V	2P+G	31-14242-K04
480V	3P+G	31-14243-K04
600V	2P+G	31-14182-K14
600V	3P+G	31-14183-K14

Voltage	Polarity	Part # Poly
120V	1P+N+G	31-18235-K16
120/208V	3P+N+G	31-18237-K16
125V	1P+N+G	31-18175-K07
125/250V	2P+N+G	31-18176-K07
208V	2P+G	31-18232-K16
208V	3P+G	31-18233-K16
250V	2P+G	31-18172-K07
250V	3P+G	31-18173-K07
277V	1P+N+G	31-18245-K04
277/480V	3P+N+G	31-18247-K04
347/600V	3P+N+G	31-18187-K14
480V	2P+G	31-18242-K04
480V	3P+G	31-18243-K04
600V	2P+G	31-18182-K14
600V	3P+G	31-18183-K14

For international configurations and ratings (IEC, CE) visit meltric.com/international-catalog or contact customer service at 800.433.7642.

Main Options



Auxiliary Contacts



Mushroom Pawl



Padlock Pawl



Closed Lid Configuration
Recommended for cord applications to keep lid tucked in to avoid damage.

Receptacle Options

Part

With 2 Auxiliary/Pilot Contacts	Recept # - 972
Type 4X & closed lid configuration	Recept # - 4X
Mushroom Pawl	Recept # - 375
Padlock Pawl	Recept # - 843
Padlockable Mushroom Pawl	Recept # -375-843
Locking Mushroom Pawl	Recept # - 845
Metal Pawl (on poly receptacle)	Recept # - 824
Closed Lid Configuration	Recept # - NC
With Auxiliary Switch	Recept # - 270*

Notes: * Not UL/CSA Listed

Inlet Options

Part

With 2 Auxiliary/Pilot contacts	Inlet # - 972
Type 4X Watertightness	Inlet # - 4X
With no lockout hole	Inlet # - A155
For Auxiliary Switch*	Inlet # - NNF

Notes: * Order inlet with P+N+G configuration and receptacle with P+G configuration.

DR30 Order Example:

To order 2 auxiliary/pilot contacts on an inlet and receptacle add **-972** to the part numbers.

DR30 Inlet 3P+G = 31-18243-K04-**972**

DR30 Receptacle 3P+G = 31-14243-K04-**972**

Appropriate accessory part numbers must also be included on the order.



See pgs 211-220 for detailed information on these options

Installation Accessories

Handles



NPT	Poly Handle	Cable Range	Nylon Handle	Poly Handle w/Clamp & Bushing
1/2"	1PH12	.20 - .83	FH111	-
3/4"	1PH34	.32 - .88	-	-
1"	1PH1	.750 - .875	-	1PM514
1 1/4"	1PH114	.875 - 1.000	-	1PM516
		1.000 - 1.125	-	1PM518
		1.125 - 1.250	-	1PM520
		1.250 - 1.375	-	1PM522

- Notes:**
- Finger draw plates are recommended for easier connector closure on cord to cord assemblies.
 - For available cord grips, see pgs 169-170.

Angles



Nylon 30° Angle	Metal 30° Angle	Metal Angle FS/FD Box 30°	Metal Straight Adapter
MP2	MA2	MAFS2*	MS2

* MAFS2 base measures approximately 4.2" x 2.7". Due to the variation in sizes of FS boxes, please verify that your FS box matches our dimensions, if not call Customer Service for other solutions.

Junction Boxes



NPT	Metal Box	Metal Box with Nylon Angle	Poly* Conduit Entry	Poly 70°** Wall Box	Poly 70° Alum Wall Box
1/2"	MB312	31-1A053-080-12	MC212	51-BA058	59-BA058-12
3/4"	MB334	31-1A053-080-34	MC234	51-BA058	59-BA058-34
1"	MB31	31-1A053-080-1	-	51-BA058	59-BA058-1
1 1/4"	MB3114	31-1A053-080-114	-	51-BA058	59-BA058-114
1 1/2"	-	-	-	-	59-BA058-112

- * For poly devices only. ** 70° poly boxes are not drilled. Contact customer service if factory drilling is required.
 + Interior volume with receptacle installed.

Miscellaneous Accessories



Finger Drawplates	Protective** Cap	Padlockable Cap Poly	Inlet Spring-loaded Cap	Receptacle + Lockout Pin
FDP2	31-1A426	DS1PC	31-1A226	LP-843

- * Recommended for cord to cord assembly applications, for easier connector closure. + Requires Padlockable Pawl option (-843) on receptacle.
 ** For watertight seal, the male inlet must also be ordered with the 'No Lockout Hole' option (-A155).

NPT Guidelines

Cable Range	NPT
.312 - .625	1/2"
.438 - .812	3/4"
.660 - 1.000	1"
.875 - 1.375	1 1/4"

NPT sizes are determined by the cable diameter and third party cord grip.

Order Example

A typical order should include an inlet part number, a receptacle part number **AND** the matching handles, angles or other required accessories.



Male Inlet with Handle (P/Lug)
31-18243-K04 + FH111



Female Receptacle with Angle Adapter
31-14243-K04 + MP2

DR50



DR – 50A Standard Duty Plugs & Receptacles

UL/CSA Ratings

- **Max Amperage & Voltage**
50A, 600 VAC
- **Current Interruption Capability**
For current interrupting up to 250 VAC
For Switch-Rated devices, see DS & DSN sections.
- **Short Circuit Rating**
100kA
Testing was performed with RK1 current limiting fuses sized at least 100% of the devices ampacity rating.
- **Environmental Ratings**
Type 3R, IP54/IP55*
* IP54 when the plug & receptacle are mated. IP55 on the receptacle alone when the lid is latched closed.
- **Temperature Range**
Min -40°F / Max 140°F
See pg 234 for temps below -15°F.
- **Wiring Capacity**
Min 14 AWG Max 4 AWG
Aux Contacts - Max 14 AWG
* Based on THHN wire sizes
- **Applicable Standards**
UL 1682, CSA 182.1

Receptacle (female)



Don't forget to add installation accessories to your order

Inlet (male)



North American UL/CSA Configurations

Voltage	Polarity	Part # Poly
120V	1P+N+G	31-34235-K16
120/208V	3P+N+G	31-34237-K16
125V	1P+N+G	31-34175-K07
125/250V	2P+N+G	31-34176-K07
208V	2P+G	31-34232-K16
208V	3P+G	31-34233-K16
250V	2P+G	31-34172-K07
250V	3P+G	31-34173-K07
277V	1P+N+G	31-34245-K04
277/480V	3P+N+G	31-34247-K04
347/600V	3P+N+G	31-34187-K14
480V	2P+G	31-34242-K04
480V	3P+G	31-34243-K04
600V	2P+G	31-34182-K14
600V	3P+G	31-34183-K14

Voltage	Polarity	Part # Poly
120V	1P+N+G	31-38235-K16
120/208V	3P+N+G	31-38237-K16
125V	1P+N+G	31-38175-K07
125/250V	2P+N+G	31-38176-K07
208V	2P+G	31-38232-K16
208V	3P+G	31-38233-K16
250V	2P+G	31-38172-K07
250V	3P+G	31-38173-K07
277V	1P+N+G	31-38245-K04
277/480V	3P+N+G	31-38247-K04
347/600V	3P+N+G	31-38187-K14
480V	2P+G	31-38242-K04
480V	3P+G	31-38243-K04
600V	2P+G	31-38182-K14
600V	3P+G	31-38183-K14

For international configurations and ratings (IEC, CE) visit meltric.com/international-catalog or contact customer service at 800.433.7642.

Main Options



Auxiliary Contacts



Mushroom Pawl



Padlock Pawl



Closed Lid Configuration

Recommended for cord applications to keep lid tucked in to avoid damage.

Receptacle Options

Part

With 2 Auxiliary/Pilot Contacts	Recept # - 972
With 3 Auxiliary/Pilot Contacts	Recept # - 973
With 4 Auxiliary/Pilot Contacts	Recept # - 974
Type 4X & closed lid configuration	Recept # - 4X
Mushroom Pawl	Recept # - 375
Padlock Pawl	Recept # - 843
Padlockable Mushroom Pawl	Recept # - 375-843
Locking Mushroom Pawl	Recept # - 845
Metal Pawl (on poly receptacle)	Recept # - 824
Closed Lid Configuration	Recept # - NC
With Auxiliary Switch	Recept # - 270*

Inlet Options

Part

With 2 Auxiliary/Pilot Contacts	Inlet # - 972
With 3 Auxiliary/Pilot Contacts	Inlet # - 973
With 4 Auxiliary/Pilot Contacts	Inlet # - 974
Type 4X Watertightness	Inlet # - 4X
With No Lockout Hole	Inlet # - A155
For Auxiliary Switch*	Inlet # - NNF

Notes: * Order inlet with P+N+G configuration and receptacle with P+G configuration.

DR50 Order Example:

To order 2 auxiliary/pilot contacts on an inlet and receptacle add **-972** to the part numbers.

DR50 Inlet 3P+G = 31-38243-K04-**972**

DR50 Receptacle 3P+G = 31-34243-K04-**972**

Appropriate accessory part numbers must also be included on the order.



See pgs 211-220 for detailed information on these options

Installation Accessories

Handles



Not Type 3R

Makes connector closures easier

NPT	Poly Handle	Cable Range	Nylon Handle	Neoprene Handle	Poly Handle w/Clamp & Bushing	Poly Handle w/built in Draw Grips
1/2"	3PH12	.32 - 1.25	-	-	-	FH311-473
3/4"	3PH34	.38 - 1.12	-	31-311	-	-
1"	3PH1	.39 - 1.18	FH311	-	-	-
1 1/4"	3PH114	.750 - .875	-	-	3PM514	-
		.875 - 1.000	-	-	3PM516	-
		1.000 - 1.125	-	-	3PM518	-
		1.125 - 1.250	-	-	3PM520	-
		1.250 - 1.375	-	-	3PM522	-

- Notes:**
- For available cord grips, see pgs 169-170.
 - For a guideline of NPT sizes based on cable ranges, see DR30 on pg 96.

Angles



Nylon 30° Angle	Metal 30° Angle	Metal 70° Angle	Metal Angle FS/FD Box 30°	Metal Straight Adapter
MP3	MA3	89-3A027	MAFS3*	MS3

* MAFS3 base measures approximately 4.2" x 2.7". Due to the variation in sizes of FS boxes, please verify that your FS box matches our dimensions, if not call Customer Service for other solutions.

Junction Boxes

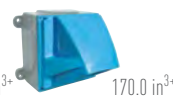
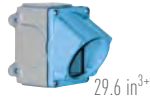

NPT	Metal Box	Metal Box with Nylon Angle	Poly* Conduit Entry	Poly 70°** Wall Box	Poly 70° Alum Wall Box
1/2"	MB312	31-3A053-080-12	-	51-CA058	59-CA058-12
3/4"	MB334	31-3A053-080-34	MC334	51-CA058	59-CA058-34
1"	MB31	31-3A053-080-1	MC31	51-CA058	59-CA058-1
1 1/4"	MB3114	31-3A053-080-114	-	51-CA058	59-CA058-114
1 1/2"	-	-	-	-	59-CA058-112

* For poly devices only. ** 70° poly boxes are not drilled. Contact customer service if factory drilling is required.
 + Interior volume with receptacle installed.

Miscellaneous Accessories



* Set of Two (2)



For Male Devices Only



For Male Devices Only



Finger Drawplates	Protective** Cap	Padlockable Cap Poly	Inlet Spring-Loaded Cap	Receptacle + Lockout Pin
FDP3	31-3A426	DS3PC	31-3A226	LP-843

* Recommended for cord to cord assembly applications, for easier connector closure. + Requires Padlockable Pawl option (-843) on receptacle.
 ** For watertight seal, the male inlet must also be ordered with the 'No Lockout Hole' option (-A155).

Accessory Spotlight

Receptacle Locking Pin



A 5/16" locking pin can be ordered to securely lockout receptacles that include the 'padlockable pawl' option. The user can also utilize a lock with a 5/16" shank. Locks with smaller shanks will NOT securely lockout a receptacle pawl.

Order Example

A typical order should include an inlet part number, a receptacle part number **AND** the matching handles, angles or other required accessories.



Male Inlet with Handle (Plug)
31-38243-K04 + FH311



Female Receptacle with Angle Adapter
31-34243-K04 + MP3

DR100



DR – 100A Standard Duty Plugs & Receptacles

UL/CSA Ratings

- **Max Amperage & Voltage**
100A, 600 VAC
- **Current Interruption Capability**
For current interrupting up to 250 VAC
For Switch-Rated devices, see DS & DSN sections.
- **Short Circuit Rating**
100kA
Testing was performed with RK1 current limiting fuses sized at least 100% of the devices ampacity rating.
- **Environmental Ratings**
Type 3R, IP54/IP55*
* IP54 when the plug & receptacle are mated. IP55 on the receptacle alone when the lid is latched closed.
- **Temperature Range**
Min -40°F / Max 140°F
See pg 234 for temps below -15°F.
- **Wiring Capacity**
Min 10 AWG Max 2 AWG
Aux Contacts - Max 14 AWG
* Based on THHN wire sizes
- **Applicable Standards**
UL 1682, CSA 182.1

Receptacle (female)



Don't forget to add installation accessories to your order

Inlet (male)



North American UL/CSA Configurations

Voltage	Polarity	Part #	
		Poly	Metal
120V	1P+N+G	31-64235-K16	39-64235-K16
120/208V	3P+N+G	31-64237-K16	39-64237-K16
125V	1P+N+G	31-64175-K07	39-64175-K07
125/250V	2P+N+G	31-64176-K07	39-64176-K07
208V	2P+G	31-64232-K16	39-64232-K16
208V	3P+G	31-64233-K16	39-64233-K16
250V	2P+G	31-64172-K07	39-64172-K07
250V	3P+G	31-64173-K07	39-64173-K07
277V	1P+N+G	31-64245-K04	39-64245-K04
277/480V	3P+N+G	31-64247-K04	39-64247-K04
347/600V	3P+N+G	31-64187-K14	39-64187-K14
480V	2P+G	31-64242-K04	39-64242-K04
480V	3P+G	31-64243-K04	39-64243-K04
600V	2P+G	31-64182-K14	39-64182-K14
600V	3P+G	31-64183-K14	39-64183-K14

Voltage	Polarity	Part #	
		Poly	Metal
120V	3P+N+G	31-68235-K16	39-68235-K16
120/208V	3P+N+G	31-68237-K16	39-68237-K16
125V	1P+N+G	31-68175-K07	39-68175-K07
125/250V	2P+N+G	31-68176-K07	39-68176-K07
208V	2P+G	31-68232-K16	39-68232-K16
208V	3P+G	31-68233-K16	39-68233-K16
250V	2P+G	31-68172-K07	39-68172-K07
250V	3P+G	31-68173-K07	39-68173-K07
277V	1P+N+G	31-68245-K04	39-68245-K04
277/480V	3P+N+G	31-68247-K04	39-68247-K04
347/600V	3P+N+G	31-68187-K14	39-68187-K14
480V	2P+G	31-68242-K04	39-68242-K04
480V	3P+G	31-68243-K04	39-68243-K04
600V	2P+G	31-68182-K14	39-68182-K14
600V	3P+G	31-68183-K14	39-68183-K14

For international configurations and ratings (IEC, CE) visit meltric.com/international-catalog or contact customer service at 800.433.7642.

Main Options



Auxiliary Contacts



Mushroom Pawl



Padlock Pawl



Closed Lid Configuration

Recommended for cord applications to keep lid tucked in to avoid damage.



See pgs 211-220 for detailed information on these options

Receptacle Options

Part

With 2 Auxiliary/Pilot Contacts	Recept # - 972
With 3 Auxiliary/Pilot Contacts	Recept # - 263*
Type 4X & closed lid configuration	Recept # - 4X
Mushroom Pawl	Recept # - 375
Padlock Pawl	Recept # - 843
Padlockable Mushroom Pawl	Recept # - 375-843
Locking Mushroom Pawl	Recept # - 845
Metal Pawl (on poly receptacle)	Recept # - 824
Closed Lid Configuration	Recept # - NC
With Auxiliary Switch	Recept # - 270**

Notes: + Not available for metal devices, not UL/CSA listed.
++ Not UL/CSA listed.

Inlet Options

Part

With 2 Auxiliary/Pilot Contacts	Inlet # - 972
With 3 Auxiliary/Pilot Contacts	Inlet # - 263*
Type 4X Watertightness	Inlet # - 4X
With No Lockout Hole	Inlet # - A155
For Auxiliary Switch*	Inlet # - NNF

Notes: * Order inlet with P+N+G configuration and receptacle with P+G configuration.

DR100 Order Example:

To order 2 auxiliary/pilot contacts on an inlet and receptacle add **-972** to the part numbers.

DR100 Inlet 3P+G = 31-68243-K04-**972**

DR100 Receptacle 3P+G = 31-64243-K04-**972**

Appropriate accessory part numbers must also be included on the order.

Installation Accessories

Unless indicated otherwise, accessories can be used with either poly or metal plugs and receptacles

Handles



Not Type 3R

Makes connector closures easier

NPT	Poly Handle	Metal* Handle	Cable Range	Nylon Handle	Neoprene Handle	Poly Handle w/Clamp & Bushing	Poly Handle w/built in Draw Grip
1/2"	6PH12	6H12	.50 - 1.25	-	31-611	-	-
3/4"	6PH34	6H34	.51 - 1.38	FH611	-	-	FH611-473
1"	6PH1	6H1	1.250 - 1.375	-	-	6PM622	-
1 1/4"	6PH114	6H114	1.438 - 1.562	-	-	6PM625	-
1 1/2"	6PH112	6H112	1.562 - 1.688	-	-	6PM627	-
			1.688 - 1.812	-	-	6PM629	-

- Notes:**
- For available cord grips, see pgs 169-170.
 - For a guideline of NPT sizes based on cable ranges, see UK250 on pgs 104.
 - * For metal devices only.

Angles



Nylon 30° Angle	Metal 30° Angle	Metal 70° Angle	Metal Angle+ Oversized 30°	Metal Straight Adapter	Metal Lateral Angle 30°
MP6	MA6	89-6A027	MA660	MS6	MAB6

+ Mounts on oversize box only. Order with MB10xxx box. See page 102.

Junction Boxes



61.0 in³+

27.7 in³+

183.5 in³+

170.0 in³+

NPT	Metal Box	Metal Box with Nylon Angle ++	Poly* Conduit Entry	Poly 70°** Wall Box	Poly 70° Alum Wall Box
1/2"	-	-	MC612	51-DA058	59-DA058-12
3/4"	-	-	MC634	51-DA058	59-DA058-34
1"	MB61	31-6A053-080-1	MC61	51-DA058	59-DA058-1
1 1/4"	MB6114	31-6A053-080-114	MC6114	51-DA058	59-DA058-114
1 1/2"	MB6112	31-6A053-080-112	-	51-DA058	59-DA058-112
2"	MB62	31-6A053-080-2	-	51-DA058	-

- * For poly devices only. ** 70° poly boxes are not drilled. Contact customer service if factory drilling is required.
 + Interior volume with receptacle installed ++ For metal angle, replace "31" prefix with "39". Volume with metal angle is 59.4in³.

Miscellaneous Accessories



* Set of Two (2)



For Male Devices Only



For Male Devices Only



Finger Drawplates	Protective Cap	Padlockable Cap Aluminum	Inlet Spring-Loaded Cap	Receptacle + Lockout Pin
FDP6	31-6A426	DS6MC	31-6A226	LP-843

- * Recommended for cord to cord assembly applications, for easier connector closure
 + Requires Padlockable Pawl option (-843) on receptacle.

Specialty Products Spotlight

Poly 70° Wall Box



Entries and exits can be drilled in the field using pilot holes at top, bottom or sides. Large box size makes wiring easy. 70° angle reduces protrusion and minimizes impact risk.

Order Example

A typical order should include an inlet part number, a receptacle part number **AND** the matching handles, angles or other required accessories.



Male Inlet with Handle (Plug)
31-68243-K04 + FH611



Female Receptacle with Angle Adapter
31-64243-K04 + MP6

DR150



DR – 150A Standard Duty Plugs & Receptacles

UL/CSA Ratings

- **Max Amperage & Voltage**
150A, 600 VAC
- **Current Interruption Capability**
For current interrupting up to 250 VAC
For Switch-Rated devices, see DS & DSN sections.
- **Short Circuit Rating**
65kA
Testing was performed with RK1 current limiting fuses sized at least 100% of the devices ampacity rating.
- **Environmental Ratings**
Type 4X, IP66+IP67 (Poly Only)
Type 3R, IP54/IP55*(Metal Only)
* IP54 when the plug & receptacle are mated. IP55 on the receptacle alone when the lid is latched closed.
- **Temperature Range**
Min -40°F/Max 140°F
See pg 234 for temps below -15°F.
- **Wiring Capacity**
Min 4 AWG Max 2/0 AWG
Aux Contacts - Max 14 AWG
* Based on THHN wire sizes
- **Applicable Standards**
UL 1682, CSA 182.1

Receptacle (female)



Don't forget to add installation accessories to your order

Inlet (male)

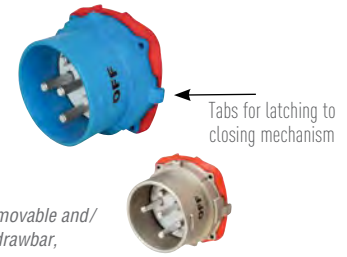

If you have an existing removable and/or permanently attached drawbar, contact customer service.

North American UL/CSA Configurations

Voltage	Polarity	Part #	
		Poly	Metal
120V	1P+N+G	31-94235-K16	39-94235-K16
120/208V	3P+N+G	31-94237-K16	39-94237-K16
125V	1P+N+G	31-94175-K07	39-94175-K07
125/250V	2P+N+G	31-94176-K07	39-94176-K07
208V	2P+G	31-94232-K16	39-94232-K16
208V	3P+G	31-94233-K16	39-94233-K16
250V	2P+G	31-94172-K07	39-94172-K07
250V	3P+G	31-94173-K07	39-94173-K07
277V	1P+N+G	31-94245-K04	39-94245-K04
277/480V	3P+N+G	31-94247-K04	39-94247-K04
347/600V	3P+N+G	31-94187-K14	39-94187-K14
480V	2P+G	31-94242-K04	39-94242-K04
480V	3P+G	31-94243-K04	39-94243-K04
600V	2P+G	31-94182-K14	39-94182-K14
600V	3P+G	31-94183-K14	39-94183-K14

Voltage	Polarity	Part #	
		Poly	Metal
120V	1P+N+G	31-98235-K16	39-98235-K16
120/208V	3P+N+G	31-98237-K16	39-98237-K16
125V	1P+N+G	31-98175-K07	39-98175-K07
125/250V	2P+N+G	31-98176-K07	39-98176-K07
208V	2P+G	31-98232-K16	39-98232-K16
208V	3P+G	31-98233-K16	39-98233-K16
250V	2P+G	31-98172-K07	39-98172-K07
250V	3P+G	31-98173-K07	39-98173-K07
277V	1P+N+G	31-98245-K04	39-98245-K04
277/480V	3P+N+G	31-98247-K04	39-98247-K04
347/600V	3P+N+G	31-98187-K14	39-98187-K14
480V	2P+G	31-98242-K04	39-98242-K04
480V	3P+G	31-98243-K04	39-98243-K04
600V	2P+G	31-98182-K14	39-98182-K14
600V	3P+G	31-98183-K14	39-98183-K14

For international configurations and ratings (IEC, CE) visit meltric.com/international-catalog or contact customer service at 800.433.7642.

Main Options



Receptacle Options

Receptacle Options	Part #
With 2 Auxiliary/Pilot contacts	Recept # - 262
With 3 Auxiliary/Pilot contacts	Recept # - 263
With 4 Auxiliary/Pilot contacts	Recept # - 264
With 5 Auxiliary/Pilot contacts	Recept # - 975
With 6 Auxiliary/Pilot contacts	Recept # - 976
Type 4X & closed lid configuration	Recept # - 4X ⁱ
Mushroom Pawl	Recept # - 375
Padlock Pawl	Recept # - 843
Padlockable Mushroom Pawl	Recept # - 375-843
Locking Mushroom Pawl	Recept # - 845
Metal Pawl (on poly receptacle)	Recept # - 824
180° Opening Lid	Recept # - 180 ⁺⁺
Closed Lid configuration	Recept # - NC
With Auxiliary Switch	Recept # - 270 ⁺⁺⁺

Inlet Options

Inlet Options	Part #
With 2 Auxiliary/Pilot contacts	Inlet # - 262
With 3 Auxiliary/Pilot contacts	Inlet # - 263
With 4 Auxiliary/Pilot contacts	Inlet # - 264
With 5 Auxiliary/Pilot contacts	Inlet # - 975
With 6 Auxiliary/Pilot contacts	Inlet # - 976
Type 4X Watertightness	Inlet # - 4X
With No Lockout Hole	Inlet # - A155
For Auxiliary Switch*	Inlet # - NNF

Notes: * Order inlet with P+N+G configuration and receptacle with P+G configuration

DR150 Order Example:

To order 2 auxiliary contacts on an inlet and receptacle add **-262** to the part numbers.

DR150 Inlet 3P+G = 31-98243-K04-**262**

DR150 Receptacle 3P+G = 31-94243-K04-**262**

Appropriate accessory part numbers must also be included on the order.

See pgs 211-220 for detailed information on these options

Notes: ++ Required when mating to rigid mounted male inlet.
+++ Not UL/CSA listed.
ⁱ Metal devices only.

Installation Accessories

Unless indicated otherwise, accessories can be used with either poly or metal plugs and receptacles.

Handles

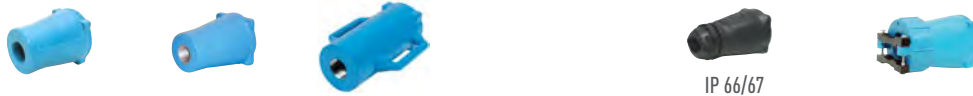

NPT	Poly Handle	Metal* Handle	Oversized* Metal Handle	Cable Range	Santoprene™ Handle	Poly Handle w/Clamp & Bushing
3/4"	9PH34	9H34	9MH34	.70 - 1.00	65-9A013-D25	-
1"	9PH1	9H1	9MH1	1.00 - 1.375	65-9A013-D35	-
1 1/4"	9PH114	9H114	9MH114	1.250 - 1.375	-	9PM622
1 1/2"	9PH112	9H112	9MH112	1.375 - 1.750	65-9A013-D45	-
2"	9PH2	9H2	9MH2	1.438 - 1.562	-	9PM625
2 1/2"	-	-	9MH212	1.562 - 1.688	-	9PM627
				1.688 - 1.812	-	9PM629

- Notes:**
- Finger draw plates are recommended for easier connector closure on cord to cord assemblies.
 - For available cord grips, see pgs 169-170.
 - * For metal devices only.
 - For a guideline of NPT sizes based on cable ranges, see DR250 on pg 104.

Angles



Nylon 30° Angle	Metal 30° Angle	Metal 70° Angle	Metal Angle* Oversized 30°	Metal Straight Adapter
MP10	MA10	89-9A027	MA110	MS10

+ Mounts on oversize box only. Order with MB22xxx box. See page 104.

Junction Boxes



NPT	Metal Box	Metal Box with Nylon Angle	Metal Box with Metal Angle
1 1/4"	MB10114	31-9A053-080-114	39-9A053-080-114
1 1/2"	MB10112	31-9A053-080-112	39-9A053-080-112
2"	MB102	31-9A053-080-2	39-9A053-080-2
2 1/2"	MB10212	31-9A053-080-212	39-9A053-080-212

+ Interior volume with receptacle installed.

Miscellaneous Accessories



Protective Cap	Padlockable Cap Aluminum	Cord Grip with Mesh	Receptacle + Lockout Pin
31-9A126	DS9MC	see pgs 169-170	LP-843

+ Requires Padlockable Pawl option (-843) on receptacle.

Feature Spotlight – Easy Closing Mechanism

A new and simplified closing mechanism is now standard on the DR150 and DR250 plugs and receptacles. This compact mechanism enables easy connection of the plug to the receptacle.

Notes: After connection, the mechanism must be released to allow disconnection of the device.

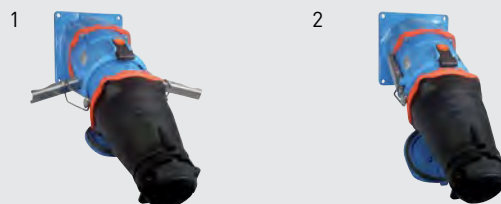

The plug is partially inserted, clamps are placed around tab, ready to pull the plug into the receptacle.

The handles are pushed down, the plug is fully drawn into the receptacle.

Order Example

A typical order should include an inlet part number, a receptacle part number **AND** the matching handles, angles or other required accessories.



Male Inlet with Handle (Plug)
39-98243-K04 + 65-9A013-D25



Female Receptacle with Angle Adapter
39-94243-K04 + MA10

DR250

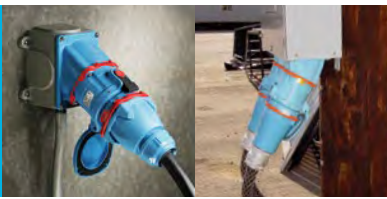

DR – 250A Standard Duty Plugs & Receptacles

UL/CSA Ratings

- **Max Amperage & Voltage**
250A, 600 VAC
- **Current Interruption Capability**
Not for current interrupting
For Switch-Rated devices, see DS & DSN sections.
- **Short Circuit Rating**
10kA
Testing was performed with RK1 current limiting fuses sized at at least 100% of the devices ampacity rating.
- **Environmental Ratings**
Type 3R, IP54/IP55*
* IP54 when the plug & receptacle are mated. IP55 on the receptacle alone when the lid is latched closed.
- **Temperature Range**
Min -40°F / Max 140°F
See pg 234 for temps below -15°F.
- **Wiring Capacity**
Min 4 AWG Max 4/0+ AWG
Aux Contacts - Max 14 AWG
* Based on THHN wire sizes
- **Applicable Standards**
UL 1682, CSA 182.1

Receptacle (female)

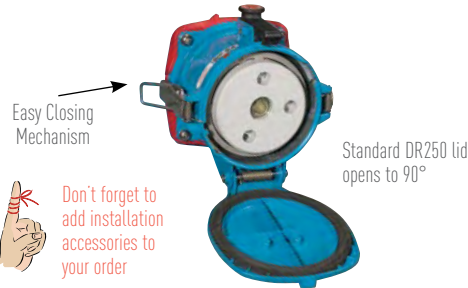

Inlet (male)

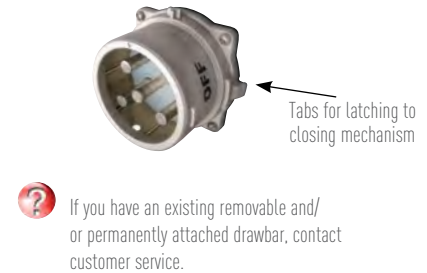

North American UL/CSA Configurations

Voltage	Polarity	Part # Metal
120V	1P+N+G	39-24235-K16
120/208V	3P+N+G	39-24237-K16
125V	1P+N+G	39-24035-K07
125/250V	2P+N+G	39-24036-K07
208V	2P+G	39-24232-K16
208V	3P+G	39-24233-K16
250V	2P+G	39-24032-K07
250V	3P+G	39-24033-K07
277V	1P+N+G	39-24245-K04
277/480V	3P+N+G	39-24247-K04
347/600V	3P+N+G	39-24027-K14
480V	2P+G	39-24242-K04
480V	3P+G	39-24243-K04
600V	2P+G	39-24022-K14
600V	3P+G	39-24023-K14

Voltage	Polarity	Part # Metal
120V	1P+N+G	39-28235-K16
120/208V	3P+N+G	39-28237-K16
125V	1P+N+G	39-28035-K07
125/250V	2P+N+G	39-28036-K07
208V	2P+G	39-28232-K16
208V	3P+G	39-28233-K16
250V	2P+G	39-28032-K07
250V	3P+G	39-28033-K07
277V	1P+N+G	39-28245-K04
277/480V	3P+N+G	39-28247-K04
347/600V	3P+N+G	39-28027-K14
480V	2P+G	39-28242-K04
480V	3P+G	39-28243-K04
600V	2P+G	39-28022-K14
600V	3P+G	39-28023-K14

For international configurations and ratings (IEC, CE) visit meltric.com/international-catalog or contact customer service at 800.433.7642.

Main Options



Receptacle Options

Receptacle Options	Part #
With 2 Auxiliary/Pilot Contacts	Recept # - 172
With 3 Auxiliary/Pilot Contacts	Recept # - 173*
With 4 Auxiliary/Pilot Contacts	Recept # - 174*
With 5 Auxiliary/Pilot Contacts	Recept # - 175*
Type 4X & closed lid configuration	Recept # - 4X
Mushroom Pawl	Recept # - 375
Padlock Pawl	Recept # - 843
Padlockable Mushroom Pawl	Recept # - 375-843
Locking Mushroom Pawl	Recept # - 845
Metal Pawl (on poly receptacle)	Recept # - 824
180° Opening Lid	Recept # - 180**
Closed Lid Configuration	Recept # - NC
With Auxiliary Switch	Recept # - 270***

Inlet Options

Inlet Options	Part #
With 2 Auxiliary/Pilot Contacts	Inlet # - 172
With 3 Auxiliary/Pilot Contacts	Inlet # - 173*
With 4 Auxiliary/Pilot Contacts	Inlet # - 174*
With 5 Auxiliary/Pilot Contacts	Inlet # - 175*
Type 4X Watertightness	Inlet # - 4X
With No Lockout Hole	Inlet # - A155
For Auxiliary Switch*	Inlet # - NNF

Notes: * Order inlet with P+N+G configuration and receptacle with P+G configuration.

DR250 Order Example:

To order 2 auxiliary/pilot contacts on an inlet and receptacle add **-172** to the part numbers.

DR250 Inlet 3P+G = 39-28243-K04-**172**

DR250 Receptacle 3P+G = 39-24243-K04-**172**

Appropriate accessory part numbers must also be included on the order.

Notes: + DR250 with this option not UL/CSA listed. This option not available with N contact.

** Required when mating to rigid mounted male inlet.

*** Not UL/CSA listed.

See pgs 211-220 for detailed information on these options

Installation Accessories

Handles



IP 66/67

NPT	Poly Handle	Metal Handle
1"	-	2H1
1 1/4"	-	2H114
1 1/2"	2PH112	2H112
2"	2PH2	2H2
2 1/2"	2PH212	2H212
3"	-	2H3

Cable Range	Santoprene™ Handle
1.00 - 1.375	35-2A013-D35
1.375 - 1.750	35-2A013-D45
1.750 - 1.900	35-2A013-D49

NPT Guidelines

Cable Range	NPT
.312 - .625	1/2"
.438 - .812	3/4"
.660 - 1.000	1"
.875 - 1.375	1 1/4"
.890 - 1.812	1 1/2"
1.190 - 2.438	2"
2.062 - 2.438	2 1/2"

- Notes:**
- Finger draw plates are recommended for easier connector closure on cord to cord assemblies.
 - For available cord grips, see pgs 169-170.

Angles



Metal 60° Angle	Metal Angle+ Oversized 45°	Metal Straight Adapter
MA20	MA220	MS20

+ Mounts on oversize box only.

Junction Boxes



	Metal Box	Metal Box for Metal Angle Oversized	Metal Box with Metal Angle
1 1/2"	MB20112	-	39-2A053-080-112
2"	MB202	-	39-2A053-080-2
2 1/2"	MB20212	MB22212	39-2A053-080-212

+ Interior volume with receptacle installed.

Miscellaneous Accessories



For Male Devices Only



For Male Devices Only



Protective Cap	Padlockable Cap Aluminum	Cord Grip with Mesh	Receptacle + Lockout Pin
35-2A126	DS2MC	see pgs 169-170	LP-843

+ Requires Padlockable Pawl option (-843) on receptacle.

Feature Spotlight – Easy Closing Mechanism

A new and simplified closing mechanism is now standard on the DR150 and DR250 plugs and receptacles. This compact mechanism enables easy connection of the plug to the receptacle.

Notes: After connection, the mechanism must be released to allow disconnection of the device.



The plug is partially inserted, clamps are placed around tab, ready to pull the plug into the receptacle.

The handles are pushed down, the plug is fully drawn into the receptacle.

Order Example

A typical order should include an inlet part number, a receptacle part number **AND** the matching handles, angles or other required accessories.



Male Inlet with Handle (Plug)
39-28247-K04 + 35-2A013-D35



Female Receptacle with Angle Adapter
39-24247-K04 + MA20

DR400



DR – 400A Standard Duty Plugs & Receptacles

UL/CSA Ratings

- Max Amperage & Voltage**
 400A Max to 480 VAC
 350A Max to 600 VAC
- Current Interruption Capability**
 Not for current interrupting
- Short Circuit Rating**
 18kA
 A withstand test was performed with RK1 current limiting fuses sized at at least 100% of the devices ampacity rating.
- Environmental Ratings IP54/ IP55***
 * IP54 when the plug & receptacle are mated. IP55 on the receptacle alone when the lid is latched closed.
- Temperature Range**
 Min -40°F / Max 140°F
- Wiring Capacity**
 Min 2 AWG Max 350 MCM
 Aux Contacts – 14 AWG (prewired)
- Applicable Standards**
 UL 1682
 CSA 182.1

Receptacle (female)

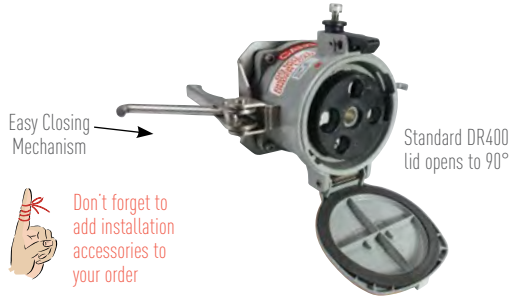

Don't forget to add installation accessories to your order

Inlet (male)



North American UL/CSA Configurations

Voltage	Polarity	Part # Metal
208V	3P+G+2PIL	39-44163-172
250V	3P+G+2PIL	39-44073-172
480V	3P+G+2PIL	39-44043-172
600V	3P+G+2PIL	39-44143-172*

Voltage	Polarity	Part # Metal
208V	3P+G+2PIL	39-48163-172
250V	3P+G+2PIL	39-48073-172
480V	3P+G+2PIL	39-48043-172
600V	3P+G+2PIL	39-48143-172*

* 350A only for 600V models.

Other voltage configurations are available – contact customer service at 800.433.7642.

For international configurations and ratings (IEC,CE) visit meltric.com/international-catalog or contact customer service at 800.433.7642.

Key Feature

Standard Locking Pawl



DR400 receptacles are provided with a screw-type locking pawl that prevents accidental disconnections under load.

Receptacle Options	Part #
IP66/IP67	Recept # - 4X
Closed Lid Configuration	Recept # - NC

Inlet Options	Part #
IP66/IP67	Inlet # - 4X
With No Lockout Hole	Inlet # - A155

DR400 Order Example:

To order IP 66/67 watertightness on an inlet and receptacle add -4X to the part numbers.

DR400 Inlet 3P+G+2PIL = 39-48043-172-4X

DR400 Receptacle 3P+G+2PIL = 39-44043-172-4X

Appropriate accessory part numbers must also be included on the order.



See pgs 211-220 for detailed information on these options

Installation Accessories

Handles



NPT Size	Metal Handle	Cable Range	Straight Handle with Bushing
2"	4MH2	2.09-2.25 in	39-4A915-57
2 1/2"	4MH212	2.25-2.44 in	39-4A915-62
3"	4MH3	2.44-2.67 in	39-4A915-68
		2.67-2.87 in	39-4A915-73

Angles

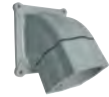

Spacer (included)	Metal Straight* Adapter	Metal 60° Angle
none	39-4A127	-
2.68 in	-	39-4A027-68

Notes: * Use metal straight adapter when mounting directly on a panel.

Junction Boxes



NPT Size	Metal Junction Box
2"	MB40DR-20
2 1/2"	MB40DR-25
3"	MB40DR-30
3 1/2"	MB40DR-35
4"	MB40DR-40

Miscellaneous Accessories



Inlet Cap	Spacer (68 mm)*	Spacer (115 mm)**
31-2A126	39-4A127-68	39-4A127-115

Notes: * 68mm (2.68") spacer is used (included) with metal 60° angle.
** 115mm spacer can be used when mounting to a panel - though the metal straight adapter is preferred.

Dimensions Provided in inches

Dimensions are for reference only and may change depending on accessories used. For precise dimensions contact MELTRIC Engineering.

receptacle

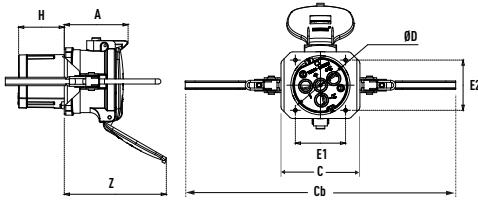

PRODUCT	A	C	Cb	E1	E2	H	Z	ØD
DR400	5.06	6.00	20.61	3.86	3.86	3.29	8.66	4.37

inlet

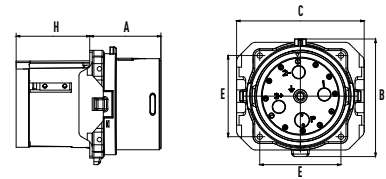

PRODUCT	A	B	C	E	H
DR400	3.48	5.59	6.06	3.86	3.43

connector

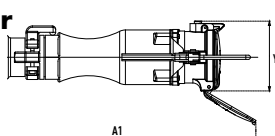

PRODUCT	A1	Y
DR400	24.27	6.47

plug

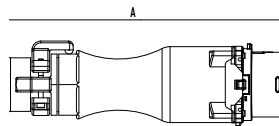

PRODUCT	A
DR400	19.10

receptacle/angle

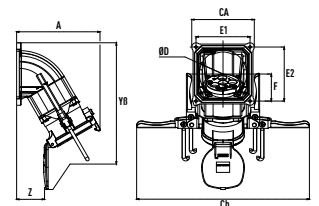

PRODUCT	A	CA	Cb	E1	E2	F	YØ	Z	ØD
DR400	10.00	7.52	20.61	6.50	6.50	3.25	17.70	4.52	5.63



DR



Spare Parts Male Configuration

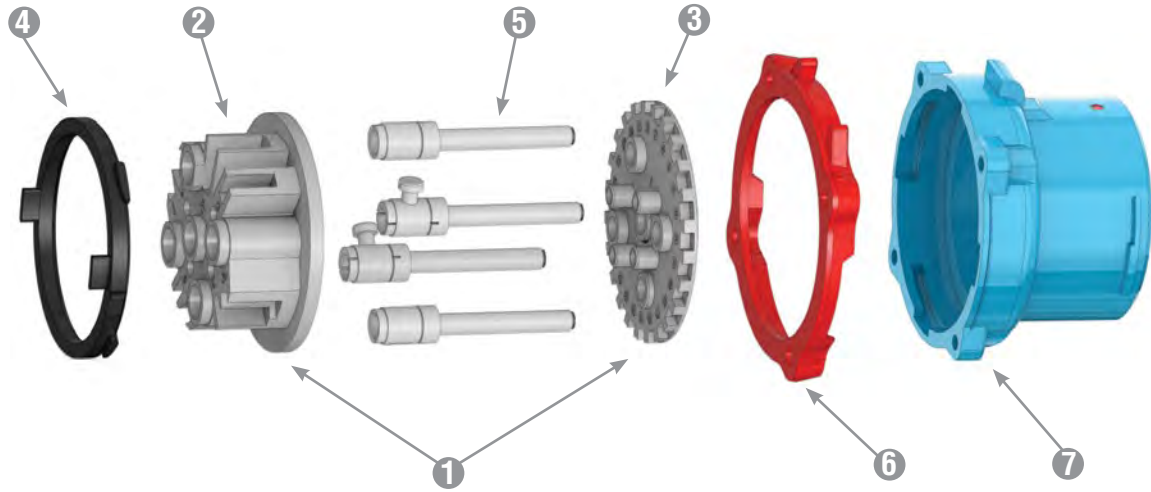

	DR30 POLY	DR50 POLY	DR100 POLY	DR100 METAL	DR150 POLY	DR150 METAL	DR250 METAL	DR400 METAL
1 = Plug Interior***	31-1A010*	31-3A010*	31-6A010*	31-6A010*	61-9A010*	69-9A010*	39-2A010*	Contact Customer Service for DR400 parts
1 = Plug Interior with Ground Contacts***	-	-	-	39-6A110*	-	69-9A110*	39-2A110*	
1 = Plug Interior with 2 pilots†	31-1A310-972*	31-3A310-972*	31-6A310-972*	31-6A310-972*	61-9A310-262*	61-9A310-262*	39-2A310-172*	
2 = Interior Bottom***	31-1A010-B	31-3A010-B	31-6A010-B	31-6A010-B	61-9A551	69-9A551	39-2A010-B	
3 = Interior Top***	31-1A010-T*	31-3A010-T*	31-6A010-T*	31-6A010-T*	61-9A010-T*	69-9A010-T*	39-2A010-T*	
4 = Polyester Locking Ring	31-1A583	31-3A583	31-6A583	-	31-9A583	-	-	
4 = Metal Locking Ring	-	-	-	39-6A583	-	39-9A583	39-2A583	
5 = Plug Phase Contact (If no aux. contacts)	31-1A011-380	31-3A011-380	31-6A011	31-6A011	61-9A011	61-9A011	39-2A011	
5 = Plug Phase Contact (If plug has aux. contacts)	31-1A011	31-3A011-380	31-6A011	31-6A011	61-9A011	61-9A011	39-2A011	
5 = Plug Ground Contact	31-1A019	31-3A019	31-6A019	39-6A019	61-9A019	69-9A019	39-2A019	
6 = Color-Coded Voltage Gasket	<div style="display: flex; align-items: center;"> <div style="width: 15px; height: 10px; border-radius: 5px; background-color: #004a7c; margin-right: 5px;"></div> <div style="font-size: 8px; margin-right: 5px;">208V</div> <div style="font-size: 8px;">31-1AB26</div> </div> <div style="display: flex; align-items: center; margin-top: 2px;"> <div style="width: 15px; height: 10px; border-radius: 5px; background-color: #e69d00; margin-right: 5px;"></div> <div style="font-size: 8px; margin-right: 5px;">250V</div> <div style="font-size: 8px;">31-1AC26</div> </div> <div style="display: flex; align-items: center; margin-top: 2px;"> <div style="width: 15px; height: 10px; border-radius: 5px; background-color: #c00000; margin-right: 5px;"></div> <div style="font-size: 8px; margin-right: 5px;">480V</div> <div style="font-size: 8px;">31-1AR26</div> </div> <div style="display: flex; align-items: center; margin-top: 2px;"> <div style="width: 15px; height: 10px; border-radius: 5px; background-color: #000000; margin-right: 5px;"></div> <div style="font-size: 8px; margin-right: 5px;">600V</div> <div style="font-size: 8px;">31-1AN26</div> </div> <div style="display: flex; align-items: center; margin-top: 2px;"> <div style="width: 15px; height: 10px; border-radius: 5px; background-color: #e69d00; margin-right: 5px;"></div> <div style="font-size: 8px; margin-right: 5px;">125V</div> <div style="font-size: 8px;">31-1AC26</div> </div>	31-3AB26	31-6AB26	31-6AB26	31-9AB26	31-9AB26	39-2AB26	
	31-1AC26	31-3AC26	31-6AC26	31-6AC26	31-9AC26	31-9AC26	39-2AC26	
	31-1AR26	31-3AR26	31-6AR26	31-6AR26	31-9AR26	31-9AR26	39-2AR26	
	31-1AN26	31-3AN26	31-6AN26	31-6AN26	31-9AN26	31-9AN26	39-2AN26	
	31-1AC26	31-3AC26	31-6AC26	31-6AC26	31-9AC26	31-9AC26	39-2AC26	
7 = Plug Polyester Casing	31-1A014**	31-3A014**	31-6A014**	-	31-9A014**	-	-	
7 = Plug Metal Casing	-	-	-	39-6A014**	-	39-9A014**	39-2A014**	

* Voltage and phasing positions must be specified (5th, 6th & 7th digit of Part #) to duplicate your shutter and alignment notches.

** For appropriate labeling on a device, please specify voltage, phasing, and product type.





*** For interiors with pilot contacts, contact Customer Service for part numbers.

† For interiors with more than 2 pilot contacts, contact Customer Service for part numbers.

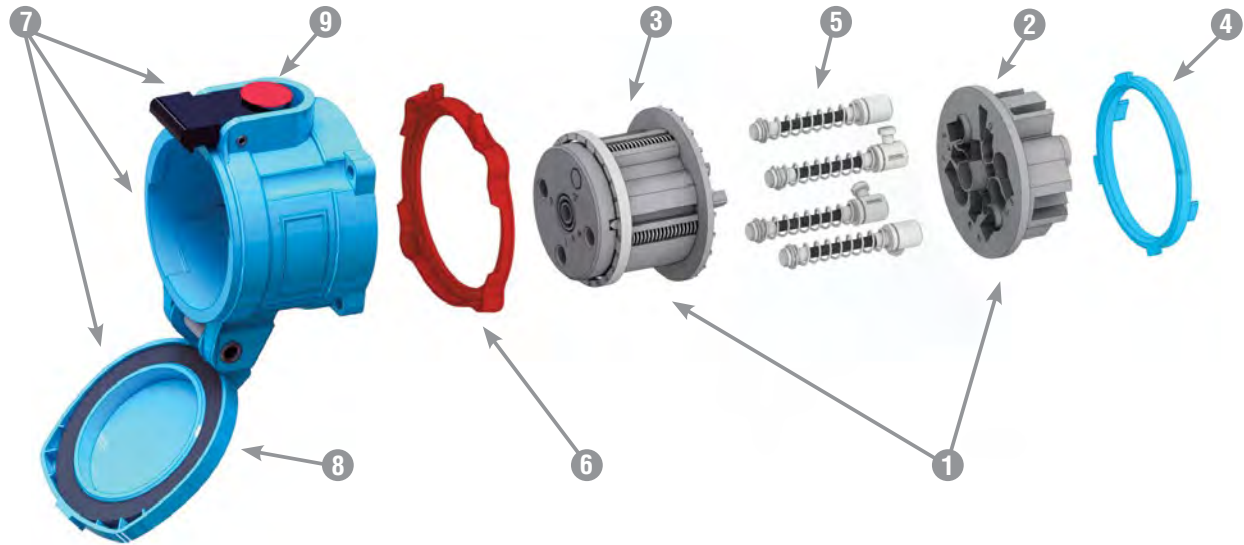
Spare Parts Female Configuration

DR



	DR30 POLY	DR50 POLY	DR100 POLY	DR100 METAL	DR150 POLY	DR150 METAL	DR250 METAL	DR400 METAL	
1 = Receptacle Interior***	31-1A020*	31-3A020*	31-6A020*	31-6A020*	61-9A020*	69-9A020*	39-2A020*		Contact Customer Service for DR400 parts
1 = Receptacle Interior with Ground Contacts***	-	-	-	39-6A220*	-	69-9A220*	39-2A220*		
1 = Receptacle Interior with 2 pilots*	31-1A320-972*	31-3A320-972*	31-6A320-972*	31-6A320-972*	61-9A320-262*	61-9A320-262*	39-2A320-172*		
2 = Interior Bottom***	31-1A020-B	31-3A020-B	31-6A020-B	31-6A020-B	61-9A552	69-9A552	39-2A020-B		
3 = Interior Top***	31-1A020-T*	31-3A020-T*	31-6A020-T*	31-6A020-T*	61-9A020-T*	69-9A020-T*	39-2A020-T*		
4 = Polyester Locking Ring	31-1A583	31-3A583	31-6A583	-	31-9A583	-	-		
4 = Metal Locking Ring	-	-	-	39-6A583	-	39-9A583	39-2A583		
5 = Recept Phase Contact (If no aux. contacts)	31-1A021-380	31-3A021-380	31-6A021	31-6A021	61-9A021	61-9A021	39-2A021		
5 = Recept Phase Contact (If plug has aux. contacts)	31-1A021	31-3A021-380	31-6A021	31-6A021	61-9A021	61-9A021	39-2A021		
5 = Recept Ground Contact	31-1A029	31-3A029	31-6A029	39-6A029	61-9A029	69-9A029	39-2A029		
6 = Color-Coded Voltage Gasket	 31-1AB26	31-3AB26	31-6AB26	31-6AB26	31-9AB26	31-9AB26	39-2AB26		
	 31-1AC26	31-3AC26	31-6AC26	31-6AC26	31-9AC26	31-9AC26	39-2AC26		
	 31-1AR26	31-3AR26	31-6AR26	31-6AR26	31-9AR26	31-9AR26	39-2AR26		
	 31-1AN26	31-3AN26	31-6AN26	31-6AC26	31-9AN26	31-9AN26	39-2AN26		
	 31-1AC26	31-3AC26	31-6AC26	31-6AC26	31-9AC26	31-9AC26	39-2AC26		
7 = Receptacle Polyester Casing with Lid	31-1A024**	31-3A024**	31-6A024**	-	61-9A024**	-	-		
7 = Receptacle Metal Casing with Lid	-	-	-	39-6A024**	-	39-9A024**	39-2A024**		
8 = Lid Replacement Kit Polyester	31-1A125	31-3A125	31-6A425	-	61-9A125	-	-		
8 = Lid Replacement Kit Metal	-	-	-	39-6A925	-	39-9A925	39-2A925		
9 = Pawl Replacement Kit Polyester	31-1A824	31-3A824	31-6A824	-	61-9A824	-	-		
9 = Pawl Replacement Kit Metal	39-1A824	39-3A824	39-6A824	39-6A824	69-9A924	39-9A824	39-2A824		

* Voltage and phasing positions must be specified (5th, 6th & 7th digit of Part #) to duplicate your shutter and alignment notches.

** For appropriate labeling on a device, please specify voltage, phasing, and product type.

*** For interiors with pilot contacts, contact Customer Service for part numbers.

+ For interiors with more than 2 pilot contacts, contact Customer Service for part numbers.

For replacement parts contact customer service at 800.433.7642

DR



Dimensions

Inlet – Provided in inches

Dimensions are for reference only and may change depending on accessories used. For precise dimensions contact MELTRIC Engineering.

plug

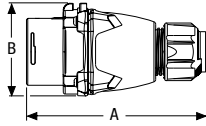

PRODUCT	A	B
DR30	5.72	2.79
DR50	6.15	3.23
DR100/DR7	6.70	3.77
DR150	8.09	4.79
DR250	10.30	5.67

Inlet with connector

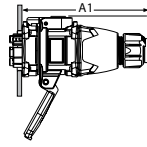

PRODUCT	A1
DR30	6.67
DR50	7.05
DR100/DR7	8.05
DR150	10.29
DR250	12.44

Inlet

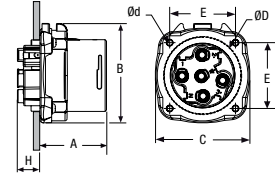

PRODUCT	A	B	C	E	H	Ød	ØD
DR30	1.86	2.76	2.57	1.89	0.72	0.20	2.07
DR50	2.07	3.23	3.07	2.17	0.86	0.20	2.48
DR100/DR7	2.38	3.77	3.60	2.60	1.04	0.24	3.15
DR150	2.96	4.79	4.50	3.19	1.09	0.24	3.81
DR250	3.20	5.67	5.79	3.86	1.46	0.26	4.57

30° inclined inlet/angle with connector

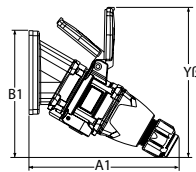

PRODUCT	A1	B1	Yβ
DR30	7.50	6.59	7.60
DR50	8.05	6.89	8.44
DR100/DR7	7.90	5.35	9.09
DR150	12.34	10.00	11.34
DR250 60°	11.08	16.81	

30° inlet/angle

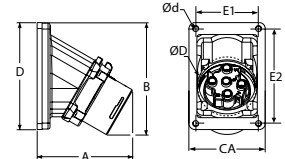

PRODUCT	A	B	CA	D	E1	E2	Ød	ØD
DR30	3.54	4.56	3.00	4.21	2.48	3.74	0.22	2.25
DR50	3.93	4.80	3.00	4.21	2.48	3.74	0.22	2.36
DR100/DR7	4.42	5.84	4.02	5.35	3.43	4.80	0.26	2.76
DR150	6.11	6.50	5.57	5.57	4.83	4.83	0.28	4.72
DR250 60°	6.90	9.10	7.20	7.20	6.50	6.50	0.25	4.80

30° inclined inlet/angle/ junction box with connector

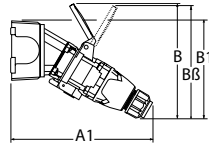

PRODUCT	A1	B	B1	Bβ
DR30	9.23	7.56	6.74	6.85
DR50	10.30	7.51	7.02	8.46
DR100/DR7	11.87	9.09	8.19	10.00
DR150	16.06	12.24	10.00	
DR250 60°	15.76	16.81	13.66	

inlet/angle/ metal junction box

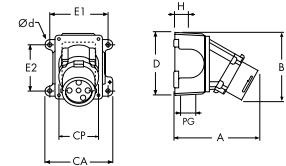

PRODUCT	A	B	CA	CP	D	E1	E2	H	PG	Ød
DR30	5.89	4.69	4.40	2.48	4.50	4.19	2.75	1.10	1.00	0.27
DR50	6.26	4.91	4.40	2.48	4.50	4.19	2.75	1.10	1.00	0.27
DR100/DR7	7.50	6.00	5.75	3.44	5.84	5.00	3.82	1.50	1.50	0.33
DR150	9.81	6.50	7.50	4.83	5.50	6.75	4.24	1.84	2.00	0.31
DR250 60°	11.60	8.96	9.26	6.50	7.25	8.13	6.38	1.92	2.50	0.31

70° inclined inlet/wall box with connector

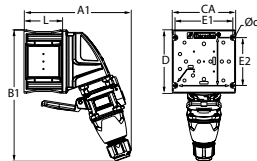

PRODUCT	A1	B1	CA	D	E1	E2	L	Ød
DR30	8.42	10.50	5.04	5.04	4.57	3.78	3.07	0.26
DR50	9.53	12.32	6.69	6.69	6.14	5.43	3.07	0.26
DR100/DR7	9.84	13.31	6.69	6.69	6.14	5.43	3.07	0.26

70° inlet/wall box

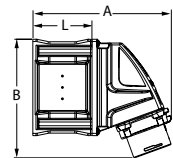

PRODUCT	A	B	L
DR30	7.17	6.14	3.07
DR50	8.19	7.70	3.07
DR100/DR7	8.31	8.31	3.07



Dimensions

Receptacle – Provided in inches

Dimensions are for reference only and may change depending on accessories used. For precise dimensions contact MELTRIC Engineering.

connector

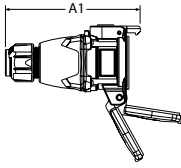

PRODUCT	A1
DR30	6.38
DR50	6.93
DR100/DR7	7.75
DR150	9.75
DR250	10.87

receptacle with plug

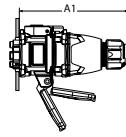

PRODUCT	A1
DR30	6.67
DR50	7.05
DR100/DR7	8.05
DR150	10.29
DR250	12.06

receptacle

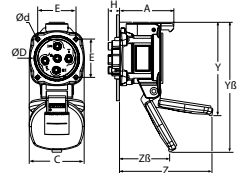

PRODUCT	A	C	E	H	Y	YB	Z	ZB	Ød	ØD
DR30	2.60	2.61	1.89	0.70	4.14	6.32	4.63	1.93	0.20	2.25
DR50	2.87	3.04	2.17	0.86	4.48	7.16	4.84	2.33	0.20	2.68
DR100/DR7	3.37	3.59	2.60	1.16	6.57	8.46	5.91	2.76	0.22	3.21
DR150	4.60	4.46	3.19	1.09	8.03	10.94	8.70	3.46	0.24	3.81
DR250	4.75	5.16	3.86	1.46	7.99	11.54	8.62	2.48	0.26	4.57

30° inclined receptacle/angle with plug

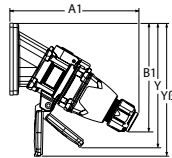

PRODUCT	A1	B1	Y	YB
DR30	7.50	6.59	6.86	7.87
DR50	8.05	6.89	8.87	8.44
DR100/DR7	7.90	8.07	10.00	10.16
DR150	12.34	10.00	12.05	12.05
DR250 60°	11.08	16.67	15.03	

30° receptacle/angle

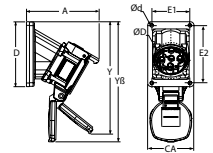

PRODUCT	A	D	E1	E2	Y	YB	Ød	ØD
DR30	4.51	4.25	2.48	3.74	6.84	7.87	0.22	2.25
DR50	4.91	4.25	2.48	3.74	8.79	8.43	0.22	2.25
DR100/DR7	5.62	5.35	3.43	4.80	9.11	10.32	0.26	2.76
DR150	7.89	5.57	4.83	4.83	12.05	12.05	0.28	4.72
DR250 60°	8.43	7.20	6.50	6.50	15.08		0.25	4.80

30° inclined receptacle/angle/junction box with plug

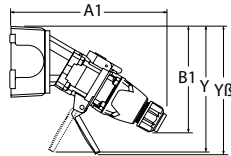

PRODUCT	A1	B1	Y	YB
DR30	9.84	6.73	7.29	7.94
DR50	10.30	7.02	8.39	8.39
DR100/DR7	11.87	8.19	10.45	9.24
DR150	16.06	9.53	11.77	
DR250 60°	15.76	13.66	11.54	

receptacle/angle/metal junction box

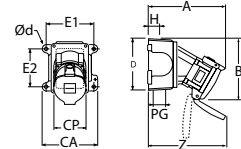

PRODUCT	A	B	CA	CP	D	E1	E2	H	PG	Z	Ød
DR30	6.86	5.37	4.40	2.61	4.50	4.19	2.75	1.10	1.00	6.77	0.27
DR50	7.25	5.62	4.40	2.70	4.50	4.19	2.75	1.10	1.00	6.77	0.27
DR100/DR7	8.75	7.00	5.75	3.44	5.84	5.00	3.82	1.50	1.50	7.56	0.33
DR150	11.50	7.80	7.50	4.83	5.50	6.75	4.24	1.84	2.00	10.28	0.33
DR250 60°	13.11	9.77	9.25	6.50	7.25	8.13	6.38	1.92	2.50	11.89	0.33

70° inclined receptacle/wall box with plug

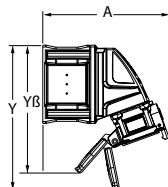

PRODUCT	A	Y	YB
DR30	8.03	9.25	9.24
DR50	9.06	9.57	11.30
DR100/DR7	9.33	12.56	10.59

70° receptacle/wall box

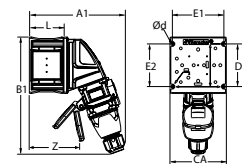

PRODUCT	A1	B1	CA	D	E1	E2	L	Z	Ød
DR30	8.41	10.50	5.00	5.00	4.57	3.78	3.07	4.91	0.26
DR50	9.53	12.32	6.69	6.69	6.14	5.43	3.07	4.91	0.26
DR100/DR7	9.76	13.03	6.69	6.69	6.22	5.47	3.07	4.09	0.26



PN

Features and Ratings	p. 112
PN20	p. 113
Spare parts	p. 115
Dimensions	p. 117

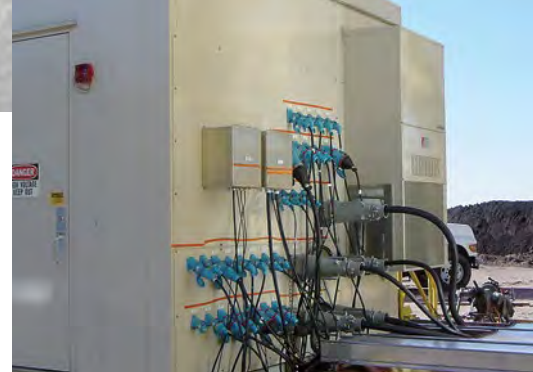

Compact plugs and receptacles – standard or high temperature rated

PN Series plugs and receptacles offer superior safety, durability and electrical performance relative to competitive devices. They feature MELTRIC's spring-loaded, silver-nickel butt contacts in a compact design that is ideal for use on small equipment and other applications where space is limited. PN devices are available with up to IP66/IP67 environmental protection. Available casing materials include glass fiber reinforced polyester (PBT) and epoxy coated Zamak.

Main Advantages

- ▶ Compact yet durable device
- ▶ Spring loaded silver-nickel contacts
- ▶ Spring assisted terminals are unaffected by vibrations and thermal cycling

Product Features

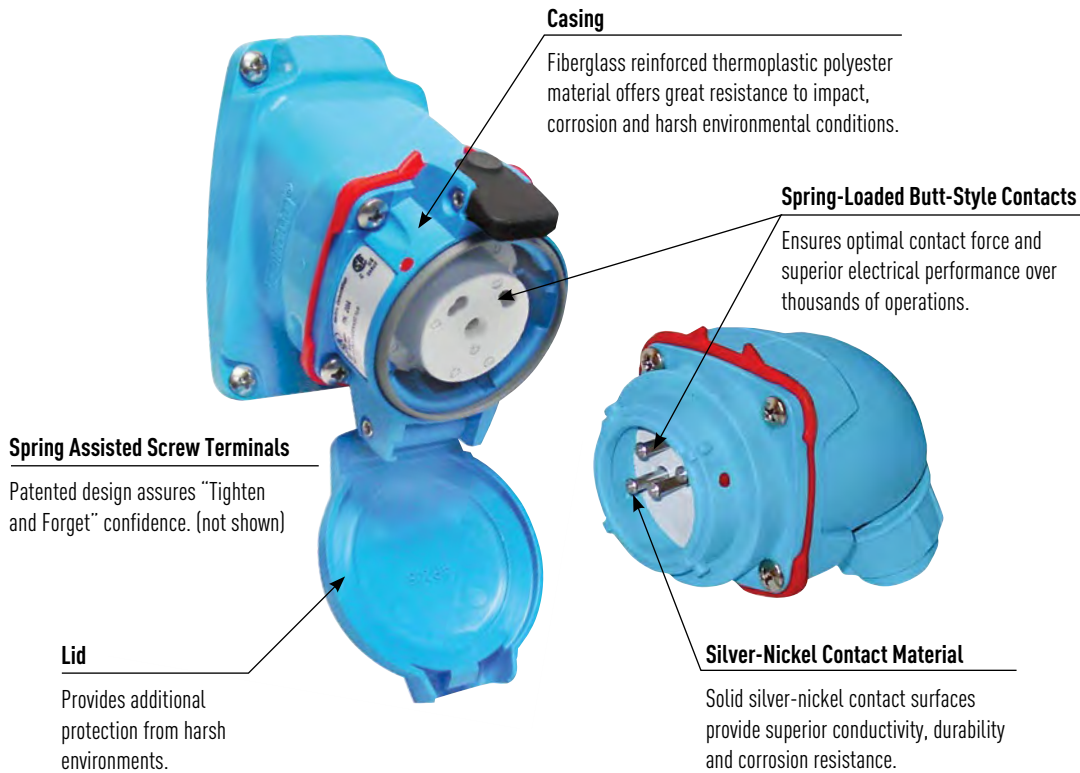

General Ratings

Amperage	20A
Voltage	600 VAC Max
Frequency	50-400 Hz
Environmental	IP66/IP67
Temperature	min -40°F/max 140°F (365° high temp model)

Current Interruption Listings

Model	Current interruption capabilities
PN20	For current interrupting

Highlighted Feature

PN Contact



PN devices feature silver-nickel, spring-loaded, butt-style contacts for superior durability and electrical performance.

Listings

Category	UL	CSA	IEC
Plugs and Receptacles	UL 1682*	C22.2 No. 182.1*	60309-1

* PN 20A devices are UL and CSA listed for current interrupting. PNHT devices are not UL/CSA listed.

Operating Instructions



To break the circuit and remove the plug, press the pawl, apply inward force and rotate the plug clockwise.



The plug can be safely withdrawn from the receptacle. The plug contacts remain shrouded until after the circuit is broken.



To reconnect, align the red dots on the plug and receptacle bodies, insert plug into the receptacle, apply insertion force and rotate the plug 20° counterclockwise.

PN20



Compact – 20A or 15A (600V) Standard Duty Plugs & Receptacles

UL/CSA Ratings

- **Max Amperage & Voltage**
20A, 600 VAC
- **Current Interruption Capability**
20A Current Interrupting (up to 480 VAC)
15A Current Interrupting (600 VAC)
- **Environmental Ratings**
Type 3R, Type 4X
- **Temperature Range**
Min -40°F / Max 140°F
See pg 234 for temps below -15°F.
- **Wiring Capacity**
Min 14 AWG Max 8 AWG
- **Applicable Standards**
UL 1682, CSA 182.01

IEC/CE Ratings

- **Environmental Ratings**
IP66/IP67*, IP54/IP55**
- * IP66/IP67 provides advanced watertightness for washdown duty applications.
- ** IP55 provides rainproof watertightness with ease of connection convenience.
- **Applicable Standards**
CE

Notes: • 600V devices are rated for current interrupting up to 15A only.

Receptacle (female)



Don't forget to add installation accessories to your order

Inlet (male)



Notes: • The same male inlet is used for IP66/IP67 or IP55 watertight ratings.

North American UL/CSA Configurations 4X, IP66/IP67 3R, IP55

Voltage	Polarity	Part #		Part #		Voltage	Polarity	Part #		Part #	
		Poly	Metal	Poly	Metal			Poly	Metal	Poly	Metal
120V	1P+N+G	01-N4165	09-N4165	01-S4165	09-S4165	120V	1P+N+G	01-N8165	09-N8165		
120/208V	3P+N+G	01-N4167	09-N4167	01-S4167	09-S4167	120/208V	3P+N+G	01-N8167	09-N8167		
125V	1P+N+G	01-N4075	09-N4075	01-S4075	09-S4075	125V	1P+N+G	01-N8075	09-N8075		
125/250V	2P+N+G	01-N4076	09-N4076	01-S4076	09-S4076	125/250V	2P+N+G	01-N8076	09-N8076		
208V	2P+G	01-N4162	09-N4162	01-S4162	09-S4162	208V	2P+G	01-N8162	09-N8162		
208V	3P+G	01-N4163	09-N4163	01-S4163	09-S4163	208V	3P+G	01-N8163	09-N8163		
250V	2P+G	01-N4072	09-N4072	01-S4072	09-S4072	250V	2P+G	01-N8072	09-N8072		
250V	3P+G	01-N4073	09-N4073	01-S4073	09-S4073	250V	3P+G	01-N8073	09-N8073		
277V	1P+N+G	01-N4045	09-N4045	01-S4045	09-S4045	277V	1P+N+G	01-N8045	09-N8045		
277/480V	3P+N+G	01-N4047	09-N4047	01-S4047	09-S4047	277/480V	3P+N+G	01-N8047	09-N8047		
480V	2P+G	01-N4042	09-N4042	01-S4042	09-S4042	480V	2P+G	01-N8042	09-N8042		
480V	3P+G	01-N4043	09-N4043	01-S4043	09-S4043	480V	3P+G	01-N8043	09-N8043		
347/600V	3P+N+G	01-N4147	09-N4147	01-S4147	09-S4147	347/600V	3P+N+G	01-N8147	09-N8147		
600V	2P+G	01-N4142	09-N4142	01-S4142	09-S4142	600V	2P+G	01-N8142	09-N8142		
600V	3P+G	01-N4143	09-N4143	01-S4143	09-S4143	600V	3P+G	01-N8143	09-N8143		

Main Options



Reverse Interiors



Flush Mount
(replaces female casing)



Locking Pawl

Receptacle Options

Part

Reverse Interiors	Recept # - 001
With Flush Mount	Recept # - 142
Locking Pawl	Recept # - 824-300

Inlet Options

Part

Reverse Interiors	Inlet # - 001
-------------------	---------------

Example:

To order a device with a reverse interior add **-001** to the inlet and receptacle part numbers.

PN20 Inlet 3P+G = 01-N4043-**001**

PN20 Receptacle 3P+G = 01-N8043-**001**

Appropriate accessory part numbers must also be included on the order.

See pgs 211-220 for detailed information on these options

Installation Accessories

Unless indicated otherwise, accessories can be used with either poly or metal plugs and receptacles

Handles



NPT	Poly Handle Threaded Opening	Metal Handle* Threaded Opening	90° Nylon Handle Threaded Opening
1/2"	01-NA013-12	H091U12	04-2A090-5-12
3/4"	01-NA013-34	H091U34	04-2A090-5-34
1"	01-NA013-1	H091U1	04-2A090-5-10

Cable Range	Straight Poly Handle	Angled Poly Handle
.35 - .69	01-NA013	01-NA313

- Notes:**
- For available cord grips, see pgs 169-170.
 - * For metal devices only.

NPT Guidelines

Cable Range	NPT	Cable Range	NPT
.312 - .625	1/2"	.660 - 1.000	1"
.438 - .812	3/4"	.875 - 1.375	1 1/4"

NPT sizes are determined by the cable diameter and third party cord grip.

Junction Boxes



NPT	Metal Box	Metal Box With Nylon Angle	Metal Box With Metal Angle	Poly Conduit Entry	Poly Straight Wall Box	Metal Straight Wall Box	Poly 70°* Wall Box
1/2"	MB312	01-NA053-080-12	09-NA053-080-12	01-NA023-12	01-NA025-12	09-NA025-12	51-AA058
3/4"	MB334	01-NA053-080-34	09-NA053-080-34	01-NA023-34	01-NA025-34	09-NA025-34	51-AA058
1"	MB331	01-NA053-080-1	09-NA053-080-1	-	-	-	51-AA058
1 1/4"	MB3114	01-NA053-080-114	09-NA053-080-114	-	-	-	51-AA058

- Notes:** * 70° boxes are not drilled. Contact customer service if factory drilling is required.

Angles



Nylon 30° Angle for MB Box	Metal 45° Angle	Metal Straight Adapter 90°	Metal 30° Angle for FS Box
01-NA027-601	09-NA027	MSPN	MAFS1*

* MAFS1 base measures approximately 4.2" x 2.7". Due to the variation in sizes of FS boxes, please verify that your FS box matches our dimensions, if not call Customer Service for other solutions.

Miscellaneous Accessories



For Male Devices Only

Protective* Cap	Flush Mount
01-2A126	01-2A142

* Will not fit devices with reverse interior option.

Order Example

A typical order should include an inlet part number, a receptacle part number **AND** the matching handles, angles or other required accessories.



Male Inlet with Handle (Plug)
01-N8043 + 01-NA313



Female Receptacle with Angle Adapter
01-N4043 + 01-NA027



Spare Parts Male Configuration

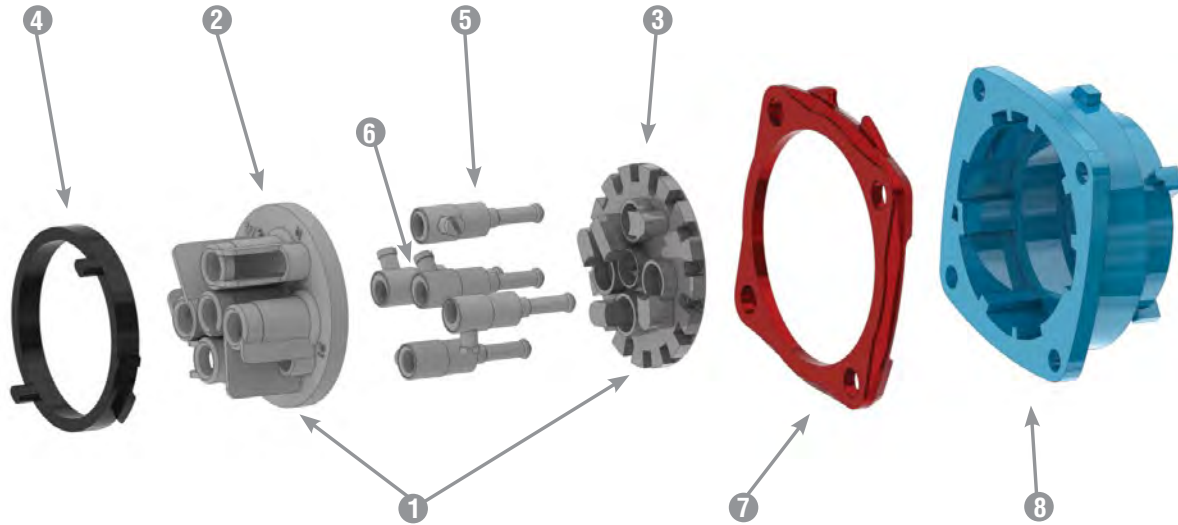

	PN20 POLY	PN20 METAL	PN20 HT METAL	
1 = Plug Interior	01-2A010*	01-2A010*	01-2A010-185*	
2 = Interior Bottom	01-2A010-B	01-2A010-B	01-2A010-185-B	
3 = Interior Top	01-2A010-T*	01-2A010-T*	01-2A010-185-T*	
4 = Locking Ring	01-NA583	09-2A583	09-2A583-185	
5 = Plug Contact	01-2A011	01-2A011	01-2A011-185	
6 = Ground Contact	01-2A019	01-2A019	01-2A019-185	
7 = Device Gasket	<div style="display: flex; align-items: center;"> <div style="width: 15px; height: 10px; border-radius: 5px; background-color: #004a7c; margin-right: 5px;"></div> 208V </div> <div style="display: flex; align-items: center;"> <div style="width: 15px; height: 10px; border-radius: 5px; background-color: #e69d00; margin-right: 5px;"></div> 250V </div> <div style="display: flex; align-items: center;"> <div style="width: 15px; height: 10px; border-radius: 5px; background-color: #c00000; margin-right: 5px;"></div> 480V </div> <div style="display: flex; align-items: center;"> <div style="width: 15px; height: 10px; border-radius: 5px; background-color: #e69d00; margin-right: 5px;"></div> 125V </div>	<div style="display: flex; align-items: center;"> <div style="width: 15px; height: 10px; border-radius: 5px; background-color: #004a7c; margin-right: 5px;"></div> 61-1AB26 </div> <div style="display: flex; align-items: center;"> <div style="width: 15px; height: 10px; border-radius: 5px; background-color: #004a7c; margin-right: 5px;"></div> 61-1AC26 </div> <div style="display: flex; align-items: center;"> <div style="width: 15px; height: 10px; border-radius: 5px; background-color: #004a7c; margin-right: 5px;"></div> 61-1AR26 </div> <div style="display: flex; align-items: center;"> <div style="width: 15px; height: 10px; border-radius: 5px; background-color: #004a7c; margin-right: 5px;"></div> 61-1AC26 </div>	<div style="display: flex; align-items: center;"> <div style="width: 15px; height: 10px; border-radius: 5px; background-color: #004a7c; margin-right: 5px;"></div> 61-1AB26 </div> <div style="display: flex; align-items: center;"> <div style="width: 15px; height: 10px; border-radius: 5px; background-color: #004a7c; margin-right: 5px;"></div> 61-1AC26 </div> <div style="display: flex; align-items: center;"> <div style="width: 15px; height: 10px; border-radius: 5px; background-color: #004a7c; margin-right: 5px;"></div> 61-1AR26 </div> <div style="display: flex; align-items: center;"> <div style="width: 15px; height: 10px; border-radius: 5px; background-color: #004a7c; margin-right: 5px;"></div> 61-1AC26 </div>	-
8 = Plug Casing	01-NA014**	09-NA014**	09-2A014-185**	

* Voltage and phasing positions must be specified (5th, 6th & 7th digit of Part #) to duplicate your shutter and alignment notches.

** For appropriate labeling on a device, please specify voltage, phasing, and product type.

Spare Parts Female Configuration

PN

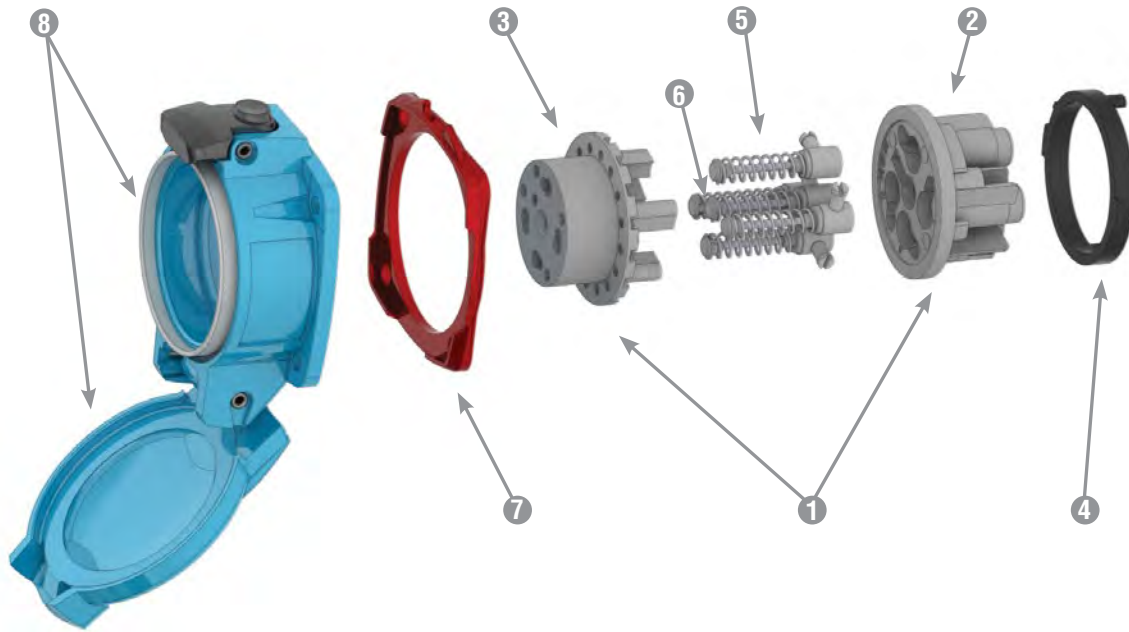

	PN20 POLY	PN20 METAL	PN20 HT METAL
1 = Receptacle Interior	01-2A020*	01-2A020*	01-2A020-185*
2 = Interior Bottom	01-2A020-B	01-2A020-B	01-2A020-185-B
3 = Interior Top	01-2A020-T*	01-2A020-T*	01-2A020-185-T*
4 = Locking Ring	01-NA583	09-2A583	09-2A583-185
5 = Receptacle Contact	01-2A021	01-2A021	01-2A021-185
6 = Ground Contact	01-2A029	01-2A029	01-2A029-185
7 = Device Gasket	<div style="display: flex; align-items: center;"> <div style="width: 20px; height: 10px; border-radius: 5px; background-color: #004a7c; margin-right: 5px;"></div> 208V <div style="width: 20px; height: 10px; border-radius: 5px; background-color: #e69d00; margin-right: 5px; margin-top: 2px;"></div> 250V <div style="width: 20px; height: 10px; border-radius: 5px; background-color: #c00000; margin-right: 5px; margin-top: 2px;"></div> 480V <div style="width: 20px; height: 10px; border-radius: 5px; background-color: #e69d00; margin-right: 5px; margin-top: 2px;"></div> 125V </div> 61-1AB26 61-1AC26 61-1AR26 61-1AC26	61-1AB26 61-1AC26 61-1AR26 61-1AC26	- - - -
8 = Recept Casing with Lid IP54/IP55	01-SA024**	09-SA024**	09-2A024-185**
8 = Recept Casing with Lid IP66/IP67	01-NA024**	09-NA024**	-

* Voltage and phasing positions must be specified (5th, 6th & 7th digit of Part #) to duplicate your shutter and alignment notches.

** For appropriate labeling on a device, please specify voltage, phasing, and product type.

PN



Dimensions

Inlet – Provided in inches

Dimensions are for reference only and may change depending on accessories used. For precise dimensions contact MELTRIC Engineering.

plug

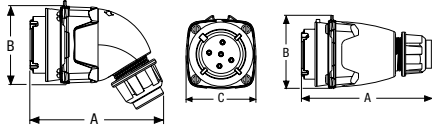

PRODUCT	A	B	C
PN/PN7/PN12 angled	3.90	3.15	2.28
PN/PN7/PN12 straight	4.33	2.40	2.28

inlet

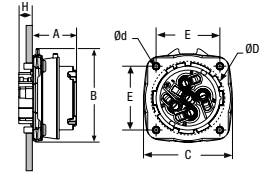

PRODUCT	A	B	C	E	H	Ød	ØD
PN/PN7/PN12	1.14	2.40	2.28	1.65	0.35	0.18	1.91

30° inclined inlet/angle with connector

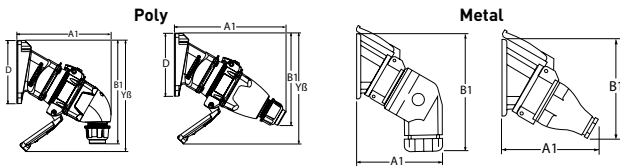

PRODUCT	A1	B1	D	Yβ
PN/PN7/PN12 angled poly	5.31	5.83	3.54	6.22
PN/PN7/PN12 straight poly	6.26	5.20	3.54	6.22
PN/PN7/PN12 angled metal	5.43	6.57		
PN/PN7/PN12 straight metal	4.84	5.43		

30° inlet/angle

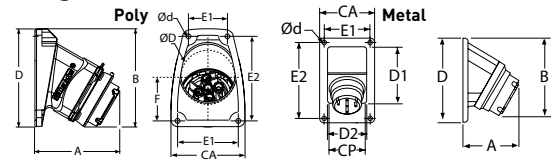

PRODUCT	A	B	CA	D	D1	D2	E1	E2	F	Ød	ØD
PN/PN7/PN12 poly	3.07	3.58	2.68	3.54			1.42	3.07	1.57	0.18	1.97
PN/PN7/PN12 metal	2.56	4.17	2.99	4.21	3.74	2.56	2.48	3.74		0.24	

30° inclined inlet/angle/ junction box with connector

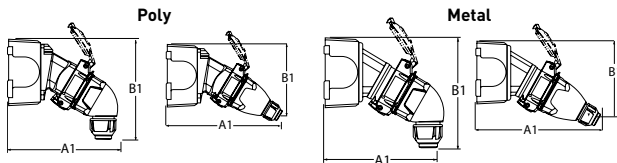

PRODUCT	A1	B1
PN/PN7/PN12 angled poly	7.52	6.30
PN/PN7/PN12 straight poly	6.73	5.67
PN/PN7/PN12 angled metal	7.91	6.69
PN/PN7/PN12 straight metal	7.32	5.55

inlet/angle/ metal junction box

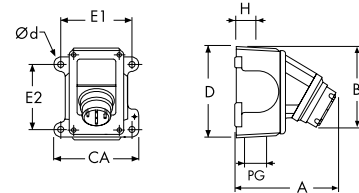

PRODUCT	A	B	CA	D	E1	E2	H	PG	Ød
PN/PN7/PN12 poly	4.53	4.06	4.40	4.57	4.19*	2.78	1.18	1.00	0.25
PN/PN7/PN12 metal	5.04	4.29	4.40	4.57	4.19*	2.78	1.18	1.00	0.25

* Note: this dimension changed on 7/1/2014 from 3.75" to 4.19".

inlet/straight wall box with connector

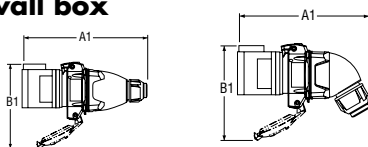

PRODUCT	A1	B1
PN/PN7/PN12 angled	6.34	3.58
PN/PN7/PN12 straight	6.02	2.76

inlet/straight wall box

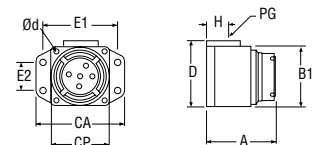

PRODUCT	A	B	CA	CP	D	E1	E2	H	PG	Ød
PN/PN7/PN12	2.60	2.17	3.07	2.17	2.40	2.52	0.94	0.69	0.50	0.22



Dimensions

Receptacle – Provided in inches

Dimensions are for reference only and may change depending on accessories used. For precise dimensions contact MELTRIC Engineering.

connector

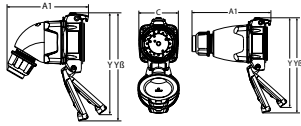

PRODUCT	A1	C	Y	YB
PN/PN7/PN12 angled	4.17	2.28	5.20	5.51
PN/PN7/PN12 straight	4.57	2.28	5.20	5.51

receptacle with plug

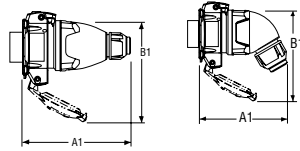

PRODUCT	A1	B1
PN/PN7/PN12 angled	4.61	2.99
PN/PN7/PN12 straight	4.72	2.99

receptacle

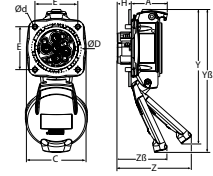

PRODUCT	A	C	E	H	Y	YB	Z	ZB	Ød	ØD
PN/PN7/PN12	1.38	2.28	1.65	0.55	5.20	5.51	2.32	1.38	0.18	1.91

30° inclined receptacle/angle with plug

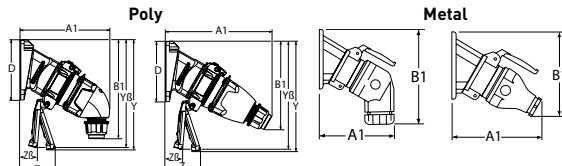

PRODUCT	A1	B1	D	Y	YB	Z	ZB
PN/PN7/PN12 angled poly	5.24	5.87	5.54	6.50	6.34	1.57	0.51
PN/PN7/PN12 straight poly	6.26	5.20	3.54	6.50	6.34	1.57	0.51
PN/PN7/PN12 angled metal	5.43	6.57					
PN/PN7/PN12 straight metal	4.84	5.43					

30° receptacle/angle

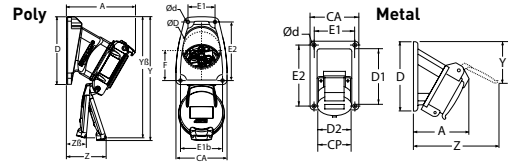

PRODUCT	A	CA	CP	D	D1	D2	E1	E1b	E2	Y	Z	ZB	Ød	ØD
PN/PN7/PN12 poly	3.62	2.68		3.54			1.42	2.20	3.07	6.50	1.57	0.51	0.18	1.97
PN/PN7/PN12 metal	3.15	2.99	2.05	4.21	3.74	2.56	2.48	2.48	3.74	6.38	2.52		0.24	

30° inclined recept/angle/ junction box w/plug

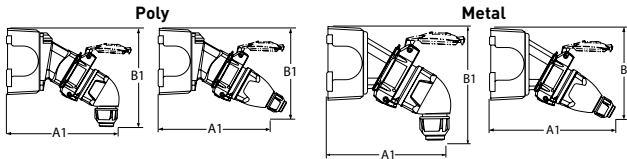

PRODUCT	A1	B1
PN/PN7/PN12 angled poly	7.13	6.30
PN/PN7/PN12 straight poly	6.93	5.16
PN angled metal	7.91	6.69
PN/PN7/PN12 straight metal	7.32	5.55

receptacle/angle/ metal junction box

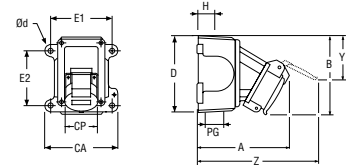

PRODUCT	A	B	CA	CP	D	E1	E2	H	PG	Y	Z	Ød
PN/PN7/PN12 poly	5.24	4.45	4.40	2.24	4.57	4.19*	2.78	1.18	1.00	6.10	4.61	0.25
PN/PN7/PN12 metal	5.63	4.84	4.40	2.05	4.57	4.19*	2.78	1.18	1.00	6.50	5.00	0.25

* Note: this dimension changed on 7/1/2014 from 3.75" to 4.19".

receptacle/straight wall box with plug

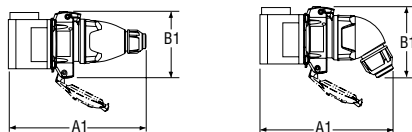

PRODUCT	A1	B1
PN/PN7/PN12 angled	5.35	3.11
PN/PN7/PN12 straight	6.38	3.01

receptacle/straight wall box

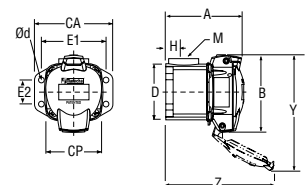

PRODUCT	A	B	CA	CP	D	E1	E2	H	PG	Y	Z	Ød
PN/PN7/PN12	2.97	3.00	3.07	2.17	2.39	2.52	0.94	0.69	0.50	5.04	4.49	0.22

High Temp



Features and Ratings
PNHT

p. 120
p. 121



High temperature rated plugs and receptacles

PNHT Series plugs and receptacles provide excellent connection quality even in high-temperature environments.

Main Advantages

- ▶ Compact yet durable
- ▶ Spring-loaded silver-nickel contacts
- ▶ Spring-assisted terminals resist vibrations and thermal cycling

Product Features



General Ratings

Amperage	30A
Voltage	480 VAC Max
Environmental	IP44
Temperature	max 465°F (240°C)*

* For temperatures higher than 365°F contact MELTRIC before ordering.

This high-temperature version of the PN is approved for use in temperatures up to 465°F / 240°C.

Therefore, you can supply power to electrical equipment located next to heat sources: machines, industrial facilities, steel works, metallurgy, etc.

Operating Instructions

Connection



Ensure that the circuit is deenergized before removing the plug from the receptacle.



To remove the plug, apply slight inward force and rotate the plug counterclockwise.

Disconnection



To reconnect open lid, align grooves in inlet with notches in the receptacle casing.



Insert and twist clockwise until plug is engaged.

PNHT



PNHT – 30A High Temperature Plugs & Receptacles

Ratings

- **Max Amperage & Voltage**
30A, 480 VAC, 130 VDC
- **Not for Current Interruption**
Not for current interrupting
- **Environmental Ratings**
IP44
- **Temperature Range**
Min -40°F / Max 465°F*
* For temperatures higher than 365°F contact MELTRIC before ordering.
- **Wiring Capacity**
Min 14 AWG Max 8 AWG
- **Applicable Standards**
IEC, CE*
* Contact Customer Service

Receptacle (female)



Don't forget to add installation accessories to your order

Inlet (male)



North American Configurations

Voltage	Polarity	Part # 30A
250V	1P+N+G	09-24015-185
250V	2P+G	09-24012-185
250V	2P+N+G	09-24016-185
250V	3P+G	09-24013-185
250V	3P+N+G	09-24017-185
480V	1P+N+G	09-24035-185
480V	2P+G	09-24032-185
480V	3P+G	09-24033-185
480V	3P+N+G	09-24037-185

Voltage	Polarity	Part # 30A
250V	1P+N+G	09-28015-185
250V	2P+G	09-28012-185
250V	2P+N+G	09-28016-185
250V	3P+G	09-28013-185
250V	3P+N+G	09-28017-185
480V	1P+N+G	09-28035-185
480V	2P+G	09-28032-185
480V	3P+G	09-28033-185
480V	3P+N+G	09-28037-185

For international configurations and ratings (IEC,CE) visit meltric.com/international-catalog or contact customer service at 800.433.7642.

Installation Accessories

Handles



NPT	Threaded Opening Metal Handle
1/2"	H091U12-185
3/4"	H091U34-185
1"	H091U1-185

Cable Range	Metal Handle
.32 - .47	09-2A913-67
.39 - .75	09-2A674-185
.63 - .94	09-2A675-185

NPT Guidelines

Cable Range	NPT
.312 - .625	1/2"
.438 - .812	3/4"
.660 - 1.000	1"
.875 - 1.375	1 1/4"

NPT sizes are determined by the cable diameter and third party cord grip.

Angles



Metal 45° Angle	Metal Straight Adapter
09-2A027-185	MSPN-185

Junction Boxes



NPT	Metal Box	Metal Box With Metal Angle	Metal Straight Wall Box
1/2"	MB312-NP	09-NA053-080-12-185	09-2A025-185-12
3/4"	MB334-NP	09-NA053-080-34-185	09-2A025-185-34
1"	MB31-NP	09-NA053-080-1-185	-
1 1/4"	MB3114-NP	09-NA053-080-114-185	-

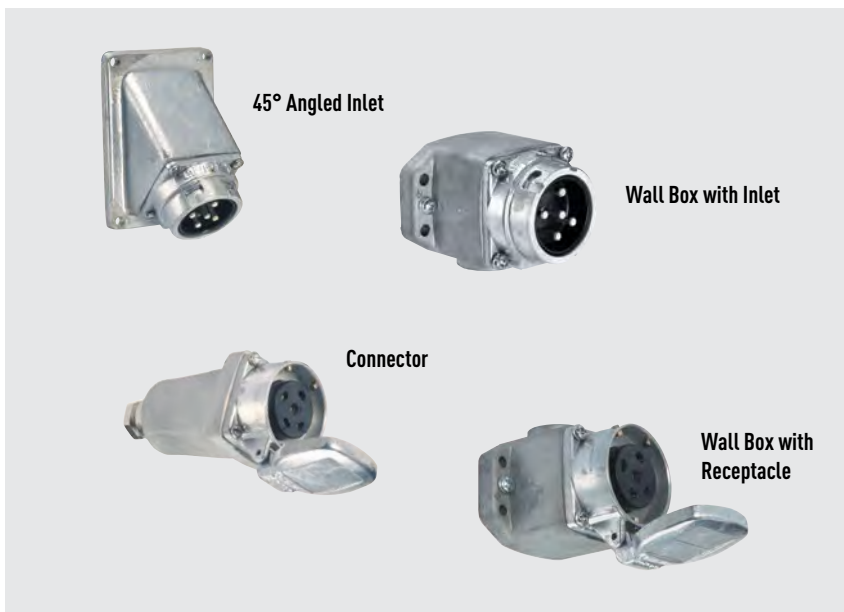

45° Angled Inlet

Wall Box with Inlet

Connector

Wall Box with Receptacle

Order Example

A typical order should include an inlet part number, a receptacle part number **AND** the matching handles, angles or other required accessories.



Male Inlet with Handle (Plug)
09-28017-185 + 09-2A913-67



Female Receptacle with Angle Adapter
09-24017-185 + 09-2A027-185

DSDC

Features and Ratings

p. 124

DSDC

p. 125



DC rated plugs and receptacles

DSDC Series plugs and receptacles provide safe and robust connections for direct current applications up to 750VDC. The DSDC's spring-loaded, silver-nickel butt contacts and dead front construction provide more consistent and reliable connections and significant improvements in operator safety. DSDC plugs and receptacles are not for current interrupting. Standard locking features should be used to prevent accidental connection or disconnection under load.

Main Advantages

- ▶ Rated for Direct Currents
- ▶ Standard locking feature enables locking in the connected and disconnected mode
- ▶ Robust poly or metal construction

Product Features

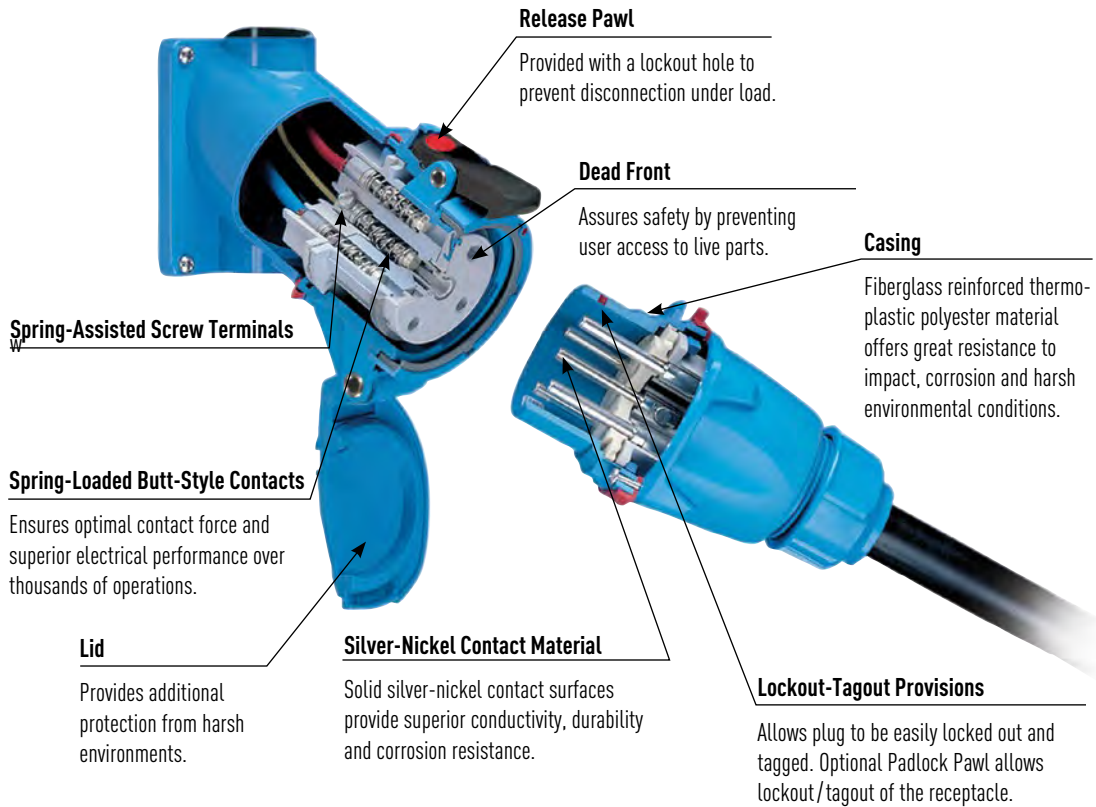

General Ratings

Voltage	130 VDC, 250 VDC, 600VDC or 750VDC
Amperage	130 VDC: 20 to 200A 250 VDC: 20 to 200A 600 VDC: 15 to 100A 750 VDC: 10 to 30A
Environmental	Type 3R, IP54/IP55*, Type 4X optional
Temperature	min -40°F/max 140°F

* IP54 rated when receptacle and plug are mated, when not mated receptacle alone is IP55 rated provided that the lid is latched closed.

Listings

Category	UL	CSA
Plugs and Receptacles	UL 1682	C22.2 No. 182.1

CE ratings available upon request

Highlighted Feature

Receptacle Lockout Hole



All DSDC models are provided with a lockout hole in the pawl. This feature allows locking of the receptacle to prevent accidental disconnection of the plug under load.

Operating Instructions



When a DSDC is under load the receptacle should be locked to prevent disconnection.



If the DSDC is NOT under load, it can be disconnected by pressing the pawl.



A quarter turn of the plug allows it to be totally withdrawn from the receptacle. This is done in complete safety as the circuit is already dead.

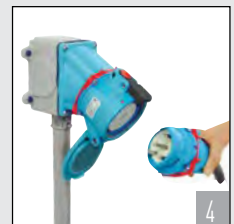

The plug and the receptacle are separated. The safety shutter prevents access to live parts.

5 To reconnect, insert plug into receptacle, twist slightly, and apply insertion force.

DSDC



DSDC – 130V, 250V, 600V, 750V Standard Duty Plugs & Receptacles

UL/CSA Ratings

- **Max Amperage & Voltage**
200A, 750 VDC
- **Current Interruption Capability**
Not for current interrupting
- **Environmental Ratings**
Type 3R, IP54/IP55*
* IP54 when the plug & receptacle are mated. IP55 on the receptacle alone when the lid is latched closed.
- **Temperature Range**
Min -40°F/Max 140°F
See pg 234 for temps below -15°F.
- **Wiring Capacity**
DSDC1 Min 14 AWG Max 8 AWG
DSDC3 Min 14 AWG Max 6 AWG
DSDC6 Min 10 AWG Max 2 AWG
DSDC9 Min 6 AWG Max 2/0 AWG
DSDC2 Min 4 AWG Max 2/0 AWG
+ 4/0 available by adding suffix "-A04" to the inlet and receptacle.
- **Applicable Standards**
UL 1682 (130, 250 & 600 VDC)
CSA 182.1 Listed up to 250 VDC
750 VDC devices pass UL testing, but are outside the scope of the standard so they cannot be listed.

Receptacle (female)

Standard lockout hole. DSDC only.



Don't forget to add installation accessories to your order

Inlet (male)



North American UL/CSA Configurations

	Voltage/Amps	Polarity	Part #		Voltage/Amps	Polarity	Part #	
			Poly	Metal			Poly	Metal
DSDC1	130V/20A	2P+G	33-14109	-	130V/20A	2P+G	33-18109	-
DSDC3	130V/30A	2P+G	33-34109	-	130V/30A	2P+G	33-38109	-
DSDC6	130V/60A	2P+G	33-64109	37-64109	130V/60A	2P+G	33-68109	37-68109
DSDC9	130V/100A	2P+G	33-94109 ⁺	37-94109 ⁺	130V/100A	2P+G	33-98109 ⁺	37-98109 ⁺
DSDC2	130V/200A	2P+G	-	37-24109	130V/200A	2P+G	-	37-28109
DSDC1	250V/20A	2P+G	33-14209	-	250V/20A	2P+G	33-18209	-
DSDC3	250V/30A	2P+G	33-34209	-	250V/30A	2P+G	33-38209	-
DSDC6	250V/60A	2P+G	33-64209	37-64209	250V/60A	2P+G	33-68209	37-68209
DSDC9	250V/100A	2P+G	33-94209 ⁺	37-94209 ⁺	250V/100A	2P+G	33-98209 ⁺	37-98209 ⁺
DSDC2	250V/200A	2P+G	-	37-24209	250V/200A	2P+G	-	37-28209
DSDC1	600V/15A	2P+G*	33-14058-S82	-	600V/15A	2P+G*	33-18058-S82	-
DSDC3	600V/30A	2P+G*	33-34058-S82	-	600V/30A	2P+G*	33-38058-S82	-
DSDC6	600V/50A	2P+G*	33-64058-S82	37-64058-S82	600V/50A	2P+G*	33-68058-S82	37-68058-S82
DSDC9	600V/60A	2P+G*	33-94058-S82 ⁺	-	600V/60A	2P+G*	33-98058-S82 ⁺	-
DSDC2	600V/100A	2P+G*	-	37-24058-S82	600V/100A	2P+G*	-	37-28058-S82
DSDC1	750V/10A	2P+G*	33-14158-S69	-	750V/10A	2P+G*	33-18158-S69	-
DSDC3	750V/20A	2P+G*	33-34158-S69	-	750V/20A	2P+G*	33-38158-S69	-
DSDC6	750V/30A	2P+G*	33-64158-S69	37-64158-S69	750V/30A	2P+G*	33-68158-S69	37-68158-S69

Notes: * Type 4x as standard
* Polarity for connection purposes. Devices have additional contacts used for load splitting. See information below.

For international configurations and ratings (IEC, CE) visit meltric.com/international-catalog or contact customer service at 800.433.7642.

Receptacle Options Part

Type 4X Recept # - 4X
Watertightness

Metal Pawl Recept # - 824
(on poly receptacle)

Closed Lid Recept # - NC
Configuration

DSDC2 models are also provided with a screw locking pawl to provide an alternative means of preventing accidental disconnection under load.

Inlet Options Part

Type 4X Inlet # - 4X
Watertightness

With No Lockout Hole Inlet # - A155

Jumpers provided on 600 VDC and 750 VDC models

Jumpers are required on all 600 VDC and 750 VDC models as a safety precaution to split the arc in case of accidental disconnection under load. Plugs and receptacles are provided with jumpers installed. Receptacles utilize a jumper between N and L3 poles. Plugs utilize a jumper between L2 and N poles.

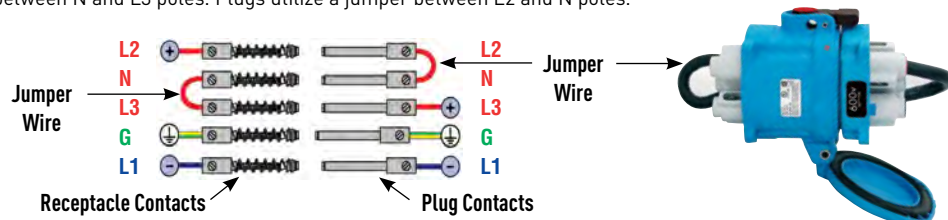

Installation Accessories

Handles



Nylon Handle



Poly Handle



Poly Handle

DSDC1, 3, 6 shown

DSDC9, 2 shown

	Cable Range	Nylon Handle	Poly Handle						
			1/2" NPT	3/4" NPT	1" NPT	1 1/4" NPT	1 1/2" NPT	2" NPT	2 1/2" NPT
DSDC1	.20 - .83	FH111	1PH12	1PH34	1PH1	1PH114	-	-	-
DSDC3	.39 - 1.18	FH311	3PH12	3PH34	3PH1	3PH114	-	-	-
DSDC6	.51 - 1.38	FH611	6PH12	6PH34	6PH1	6PH114	6PH112	-	-
DSDC9	-	-	-	9PH34	9PH1	9PH114	9PH112	9PH2	-
DSDC2	-	-	-	-	2PH1	2PH114	2PH112	2PH2	2PH212

- Notes:**
- Finger draw plates are recommended for easier connector closure on cord to cord assemblies.
 - For available cord grips, see pgs 169-170.

Angles



	Nylon 30° Angle	Metal 30° Angle	Metal Angle FS/FD Box 30°	Metal Straight Adapter	Poly 70°*** Wall Box
DSDC1	MP2	MA2	MAFS2*	MS2	51-BA058
DSDC3	MP3	MA3	MAFS3*	MS3	51-CA058
DSDC6	MP6	MA6	-	MS6	51-DA058
DSDC9	MP10	MA10	-	MS10	-
DSDC2	-	MA20 (60°)	-	MS20	-

* MAFS2 and MAFS3 base measures approximately 4.2" x 2.7". Due to the variation in sizes of FS boxes, please verify that your FS box matches our dimensions, if not call Customer Service for other solutions.
 ** 70° boxes are not drilled. Contact customer service if factory drilling is required.

Miscellaneous Accessories



* Set of Two (2)



For Male Devices Only



For Male Devices Only



	Finger Drawplates	Protective Cap	Padlockable Cap Poly	Inlet Spring-loaded Cap
FDP2	31-1A426	DS1PC	31-1A226	-
FDP3	31-3A426	DS3PC	31-3A226	-
FDP6	31-6A426	DS6PC	31-6A226	-
**	31-9A126	DS9MC***	-	-
**	35-2A126	DS2MC***	-	-

* Recommended for cord to cord assembly applications, for easier connector closure.
 ** An easy closing mechanism is standard on DSDC9 and DSDC2.
 *** Padlockable Cap Aluminum - Not pictured.

Junction Boxes



Metal Box

DSDC1, 3, 6 shown



Metal Box

DSDC9, 2 shown

	1/2" NPT	3/4" NPT	1" NPT	1 1/4" NPT	1 1/2" NPT	2" NPT	2 1/2" NPT
DSDC1	MB312	MB334	MB31	MB3114	-	-	-
DSDC3	MB312	MB334	MB31	MB3114	-	-	-
DSDC6	-	-	MB61	MB6114	MB6112	MB62	-
DSDC9	-	-	-	MB10114	MB10112	MB102	MB10212
DSDC2	-	-	-	-	MB20112	MB202	MB20212



Poly Conduit Box For poly devices only

	1/2" NPT	3/4" NPT	1" NPT	1 1/4" NPT
DSDC1	MC212	MC234	-	-
DSDC3	MC312	MC334	MC31	-
DSDC6	MC612	MC634	MC61	MC6114

For DSDC dimensions use the cross reference chart below and refer to DS dimensions on pgs 53-54.

Dimensions	
DSDC1	same as DS20
DSDC3	same as DS30
DSDC6	same as DS60
DSDC9	same as DS100
DSDC2	same as DS200

PF / PFQ



Features and Ratings	p. 128
PF / PFQ 300-600A	p. 129
PF / PFQ Lugs	p. 131
Spare parts	p. 133
Dimensions	p. 134



High amperage plugs & receptacles



Watch the PF video and other product videos at meltric.com/video

PF and PFQ Series plugs and receptacles are engineered for use in high amperage applications where routine plug insertion and high reliability are required. They are ideal for power supply applications in mining, petroleum platform, ship to shore, power generation system, shipyard and other similar harsh environments.

Main Advantages

- ▶ Durable in harsh environments
- ▶ Safety features provide maximum protection
- ▶ Easy plug insertion and removal



PFQ300 devices are differentiated from similarly rated **PF300** devices in their smaller size, lighter weight and additional pilot contacts.

Product Features

Auxiliary Pilot Contacts

Provided for use with control circuits. They close after and open before the phase contacts.

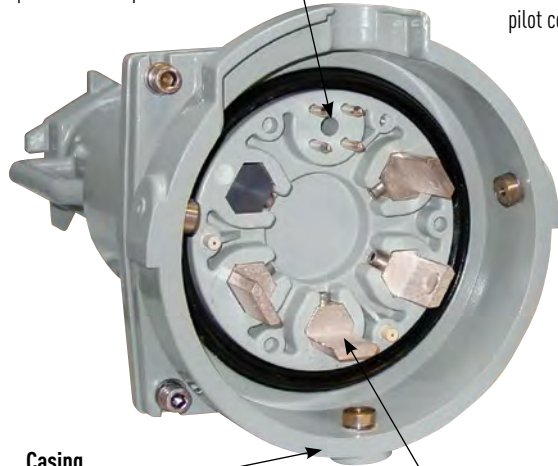

Mechanical Locking System

Ensures safety and watertightness. Mechanical lock secures the inlet to the receptacle and engages the pilot contacts.



Casing

Epoxy/powder coated aluminum material offers great resistance to harsh environments.

Silver Pressure Contacts

Silver material and self-cleaning action provides maximum conductivity and performance in dirty and corrosive conditions.

Safety Shutter

Protects recessed female contacts and inhibits user access to live parts.

General Ratings

Amperage	300 to 600A
Voltage*	1000 VAC*, 1000 VDC Max
Frequency	50-400 Hz
Environmental	IP66/IP67
Temperature	min -40°F/max 140°F

* 600 VAC max for PFQ devices.

+ UL listings do not apply above 600 VAC and 250 VDC.

Listings

Category	UL	CSA
Plugs and Receptacles	UL 1682*	C22.2 No. 182.1*

* Listings only apply to 300A and 400A devices at 600V or less.

Highlighted Feature

Pilot Contacts

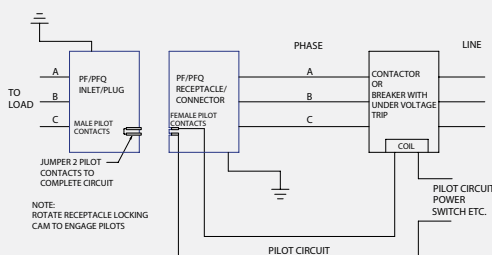

Line diagram of typical PF pilot control circuit

For multiple devices in a parallel circuit, contact factory for example control circuit diagrams.

Category	PF	PFQ
# Contacts	4	8
Pilot Amperage	10A standard duty	5A @ 240VAC
Interlocking Type	Mechanical	Mechanical
Terminal Type	Screw	Solder/crimp

- Notes:**
- The mechanical locking of the plug to the receptacle via the rotation of a cam, closes the pilot contacts.
 - Failure to use a pilot/relay system can create an electrical shock hazard.

Operating Instructions



PF devices are preferred for the ease of operation relative to pin and sleeve devices.

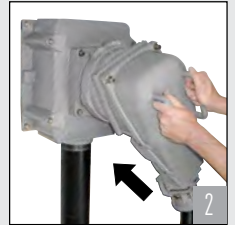

Insert the plug into the receptacle – this is done with little resistance relative to competitive devices.



Twist plug approximately 30° clockwise to engage the phase contacts and make unit watertight.



Turning the mechanical lock secures the inlet to the receptacle and engages the pilot contacts which energize the circuit.

5 To disconnect, turn mechanical lock to disengage pilot contacts and de-energize the circuit. Twist plug 30° counterclockwise to disengage the phase contacts, withdraw plug.

PF/PFQ

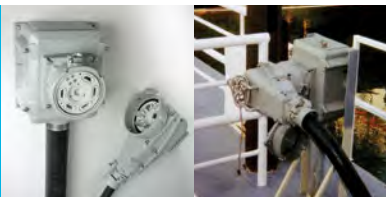

PF/PFQ – 300A - 600A High Ampacity Plugs & Receptacles

UL/CSA Ratings

- **Max Amperage & Voltage**
PF = 600A, 1000 VAC*, 250 VDC
PFQ = 300A, 600 VAC, 250 VDC
- **Current Interruption Capability**
Not for current interrupting
- **Temperature Range**
Min -40°F / Max 140°F
See pg 234 for temps below -15°F.
- **Wiring Capacity**
PFQ = 2 AWG to 600 MCM
PF = 2 AWG to 600 MCM
- **Applicable Standards**
UL 1682*, CSA 182.1*

* Listings apply only to 300A & 400A devices at 600V or less



PF/PFQ devices are not intended for connection or disconnection under load. To prevent live making or breaking electrical interlocking is required.

Receptacle/Cap (female) 300A



Don't forget to add installation accessories to your order

PFQ shown

Inlet/Cap (male) 300A



PFQ shown

North American UL/CSA Configurations

Voltage	Polarity	Part #	
		PFQ300**	PF300
277V	1P+N+G	47-34045	49-34045
347V	1P+N+G	47-34145	49-34145
480V	2P+G	47-34042	49-34042
480V	2P+N+G	47-34046	49-34046
480V	3P+G	47-34043	49-34043
480V	3P+N+G	47-34047	49-34047
600V	2P+G	47-34142	49-34142
600V	2P+N+G	47-34146	49-34146
600V	3P+G	47-34143	49-34143
600V	3P+N+G	47-34147	49-34147

Voltage	Polarity	Part #	
		PFQ300**	PF300
277V	1P+N+G	47-38045	49-38045
347V	1P+N+G	47-38145	49-38145
480V	2P+G	47-38042	49-38042
480V	2P+N+G	47-38046	49-38046
480V	3P+G	47-38043	49-38043
480V	3P+N+G	47-38047	49-38047
600V	2P+G	47-38142	49-38142
600V	2P+N+G	47-38146	49-38146
600V	3P+G	47-38143	49-38143
600V	3P+N+G	47-38147	49-38147

** PFQ300 devices are differentiated from similarly rated PF300 devices in their smaller size, lighter weight and different pilot contacts.

For international configurations and ratings (IEC,CE) visit meltric.com/international-catalog or contact customer service at 800.433.7642.

Main Options

Receptacle with no cap Recept # - 48

Receptacle with lockout hole Recept # - 843

Inlet with no cap Inlet # - 48

Inlet with lockout hole Inlet # - 843

Notes: • Metal caps are provided as standard with male and female devices.

- Heat shrink wrap is provided with each inlet and receptacle to provide insulation between terminals.
- **Lugs are not included.** The PF and PFQ contacts utilize bolt-on lug type wire terminals, which require a compression lug with a 9/16" or 5/8" hole. The angled handle requires straight lugs; the straight handle requires 90° lugs.

Receptacle/Cap (female) 400A/600A



For applications above 400A, please consult factory regarding NEC recommended conductor sizing.

Inlet/Cap (male) 400A/600A



North American UL/CSA Configurations

Voltage	Polarity	Part #	
		PF400	PF600
277V	1P+N+G	49-44045	49-64045
347V	1P+N+G	49-44145	49-64145
480V	2P+G	49-44042	49-64042
480V	2P+N+G	49-44046	49-64046
480V	3P+G	49-44043	49-64043
480V	3P+N+G	49-44047	49-64047
600V	2P+G	49-44142	49-64142
600V	2P+N+G	49-44146	49-64146
600V	3P+G	49-44143	49-64143
600V	3P+N+G	49-44147	49-64147

Voltage	Polarity	Part #	
		PF400	PF600
277V	1P+N+G	49-48045	49-68045
347V	1P+N+G	49-48145	49-68145
480V	2P+G	49-48042	49-68042
480V	2P+N+G	49-48046	49-68046
480V	3P+G	49-48043	49-68043
480V	3P+N+G	49-48047	49-68047
600V	2P+G	49-48142	49-68142
600V	2P+N+G	49-48146	49-68146
600V	3P+G	49-48143	49-68143
600V	3P+N+G	49-48147	49-68147

For international configurations and ratings (IEC,CE) visit meltric.com/international-catalog or contact customer service at 800.433.7642.

Installation Accessories

Handles



Inlet/Receptacle Size	Metal Straight Handle	Metal 90° Angled Handle
PFQ300	47-3A013-XXX	47-3A913-XXX
PF300	49-3A013-XXX	49-3A913-XXX
PF400	49-4A013-XXX	49-4A913-XXX
PF600	49-6A013-XXX	49-6A913-XXX



XXX (Suffix #)	Cable Range
-200	2.000 - 2.125
-225	2.125 - 2.250
-237	2.250 - 2.375
-250	2.375 - 2.500
-275	2.500 - 2.750
-300	2.750 - 3.000
-312	3.000 - 3.125
-335	3.125 - 3.350
-350	3.350 - 3.577



NPT Adapter

or

XXX (Suffix #)	NPT Size
-N20	2.0" NPT
-N25	2.5" NPT
-N30	3.0" NPT

Notes: • For available cord grips, see pgs 169-170.

Junction Boxes



Inlet/Receptacle Size	Hub Sizes	Metal Junction Box
PFQ300	See table	MB40PFQ-XX
PF300	See table	MB40-XX
PF400	See table	MB40-XX
PF600	See table	MB40-XX

Hub Sizes

XX (Suffix #)	Fitting Size
-20	2" NPT
-25	2.5" NPT
-30	3" NPT
-35	3.5" NPT
-40	4" NPT

Accessory Spotlight

NPT Adapter

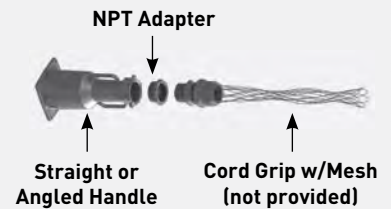

A NPT adapter accessory allows the user to connect a third party cord grip to the PF/PFQ handle.

Miscellaneous Accessories



Inlet/Receptacle Size	Inlet Metal Cap	Receptacle Metal Cap
PFQ300	47-3A126	47-3A925
PF300	49-3A126	49-3A925
PF400	49-4A126	49-4A925
PF600	49-6A126	49-6A925

Highlighted Feature

Bolt-on Lug (not included)

Angled Lug Straight Lug

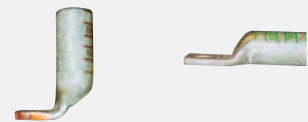

The PF and PFQ contacts utilize bolt-on lug type wire terminals, which require a compression lug with a 9/16" or 5/8" hole. The angled handle requires straight lugs; the straight handle requires 90° lugs. **Lugs are not included. See following page.**

Weights

Part	PF	PFQ
Inlet	15 lbs	9 lbs
Receptacle	25 lbs	12 lbs
Angled Handle	15 lbs	12 lbs
Straight Handle	10 lbs	10 lbs
Junction Box	45 lbs	45 lbs
Cap	3 lbs	3 lbs

Order Example

A typical order should include an inlet part number, a receptacle part number **AND** the matching handles, angles or other required accessories. **(Lugs are not included.)**



Male Inlet with Handle (Plug) 47-38047 + 47-3A913-200



Female Receptacle w/Junction Box 47-34047 + MB40-20

PF/PFQ

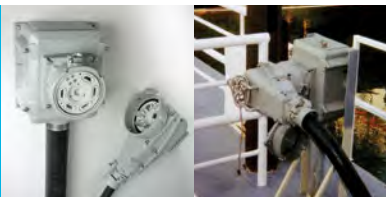

PF/PFQ – 300A - 600A High Ampacity Plugs & Receptacles

Straight Barrel Lugs

MELTRIC recommends using lugs with tangs that do not exceed 1 3/4".



Lugs are not included with PF/PFQ devices - order separately

Part Number	Wire Size
PFLUG4	4 AWG
PFLUG3	3 AWG
PFLUG2	2 AWG
PFLUG1	1 AWG
PFLUG10	1/0 AWG
PFLUG20	2/0 AWG
PFLUG30	3/0 AWG
PFLUG40	4/0 AWG
PFLUG250	250kcmil
PFLUG300	300kcmil
PFLUG350	350kcmil
PFLUG400	400kcmil
PFLUG500	500kcmil
PFLUG600	600kcmil
PFLUG650	650kcmil

Application Note

Installation Accessory: Angled Handle



Straight Barrel Lugs are utilized on PF/PFQ devices along with angled handles.



Typical wiring of a PF male inlet for angled handle applications.

Note: Apply heat shrink over lugs at terminals (supplied but not shown).



90° Bent Lugs



Lugs are not included with PF/PFQ devices - order separately



MELTRIC recommends using lugs with tangs that do not exceed 1 3/4".

Part Number	Wire Size
PFLUG4-90	4 AWG
PFLUG3-90	3 AWG
PFLUG2-90	2 AWG
PFLUG1-90	1 AWG
PFLUG10-90	1/0 AWG
PFLUG20-90	2/0 AWG
PFLUG30-90	3/0 AWG
PFLUG40-90	4/0 AWG
PFLUG250-90	250kcmil
PFLUG300-90	300kcmil
PFLUG350-90	350kcmil
PFLUG400-90	400kcmil
PFLUG500-90	500kcmil
PFLUG600-90	600kcmil

Application Note

Installation Accessory: Straight Handle



90° Bent Lugs are utilized on PF/PFQ devices along with straight handles.



Typical wiring of a PF male inlet for straight handle applications.

Note: Apply heat shrink over lugs at terminals (supplied but not shown).





Spare Parts

Male Configuration

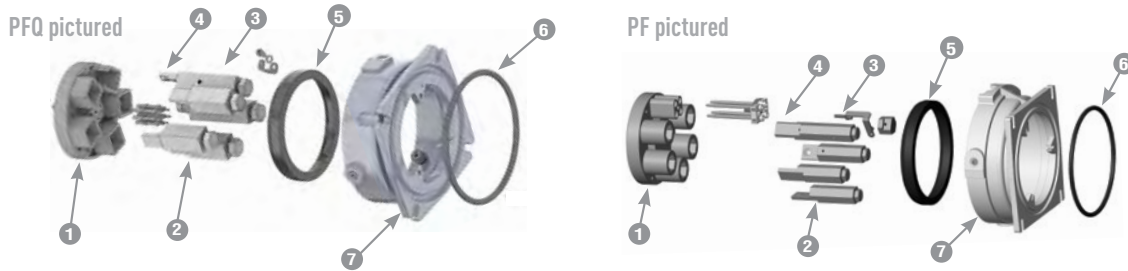

	PFQ300 METAL	PF300 METAL	PF400 METAL	PF600 METAL
1 = Plug Interior*	47-3A010 ⁺	49-3A010	49-4A010	49-6A010
1 = Plug Interior with contacts** (Pilot & Ground only)	47-3A110	49-3A110	49-4A110	49-6A110
2 = Phase Contact	47-3A011	49-3A011	49-4A011	49-6A011
3 = Neutral Contact	47-3A011N	49-4A011N	49-4A011N	49-6A011N
4 = Ground Contact	47-3A019	49-4A019	49-4A019	49-6A019
5 = Inside Gasket	CPF403PFQ	CPF403	CPF403	CPF403
6 = Outside Gasket	CPF405PFQ	CPF405	CPF405	CPF405
7 = Plug Metal Casing*	47-3A014	49-3A014	49-4A014	49-6A014

Female Configuration

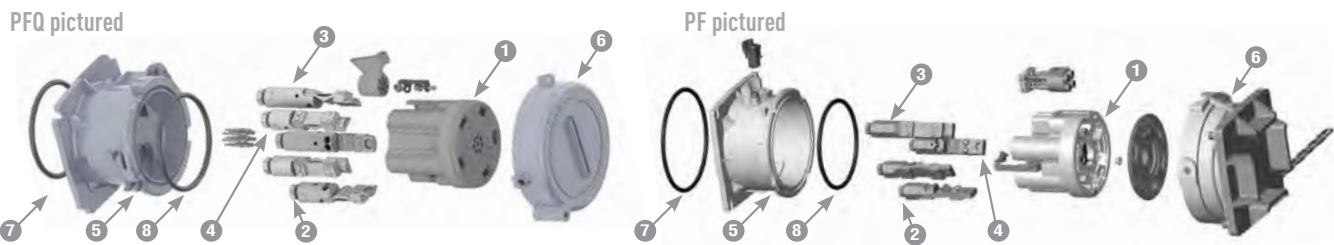

	PFQ300 METAL	PF300 METAL	PF400 METAL	PF600 METAL
1 = Receptacle Interior*	47-3A020 ⁺	49-3A020	49-4A020	49-6A020
1 = Receptacle Interior with contacts** (Pilot & Ground only)	47-3A220	49-3A220	49-4A220	49-6A220
2 = Phase Contact	47-3A021	49-3A021	49-4A021	49-6A021
3 = Neutral Contact	47-3A021N	49-3A021N	49-4A021N	49-6A021N
4 = Ground Contact	47-3A029	49-3A029	49-4A029	49-6A029
5 = Receptacle Metal Casing*	47-3A024	49-3A024	49-4A024	49-6A024
6 = Cap [Receptacle]	47-3A925	49-3A925	49-3A925	49-3A925
7 = Inside Gasket	CPF403PFQ	CPF403	CPF403	CPF403
8 = Outside Gasket	CPF405PFQ	CPF405	CPF405	CPF405

* Voltage and phasing positions must be specified (5th, 6th and 7th digit of part #).

** Includes ground and pilot contacts only.

+ Includes pilot contacts only.

Dimensions

Inlet/Receptacle – Provided in inches

Dimensions are for reference only and may change depending on accessories used. For precise dimensions contact MELTRIC Engineering.

straight plug

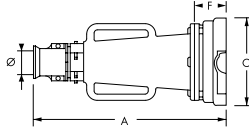

PRODUCT	A	C	F	Ø
PFQ	23.03	7.72	2.95	2.0-3.5
PF	26.57	9.06	3.74	2.0-3.5

angled plug

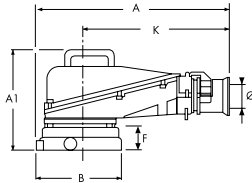

PRODUCT	A	A1	B	F	K	Ø
PFQ	18.50	11.50	9.45	2.95	13.86	2.0-3.5
PF	23.43	12.60	10.47	3.74	17.99	2.0-3.5

straight connector

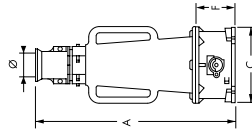

PRODUCT	A	C	F	Ø
PFQ	24.72	7.72	4.65	2.0-3.5
PF	27.56	9.06	4.72	2.0-3.5

angled connector

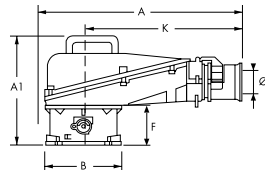

PRODUCT	A	A1	B	F	K	Ø
PFQ	18.50	13.15	9.45	4.65	14.65	2.0-3.5
PF	23.43	13.39	9.84	4.72	17.99	2.0-3.5

inlet

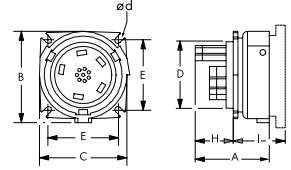

PRODUCT	A	B	C	D	E	H	I	Ød
PFQ	6.10	9.45	7.72	5.31	5.75	3.15	6.89	0.43
PF	7.68	10.47	9.06	6.89	7.48	3.94	8.27	0.43

inlet on surface box

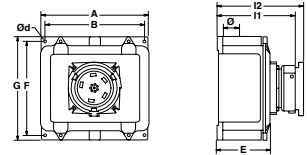

PRODUCT	A	B	E	F	G	I1	I2	Ø	Ød
PFQ/PF	15.70	14.63		13.75	15.15			2.0-4.0	0.41
PFQ	15.70	14.63	8.62	13.75	15.15	11.62	16.87	2.0-4.0	0.41
PF	15.70	14.63	8.81	13.75	15.15	12.56	19.44	2.0-4.0	0.41

receptacle

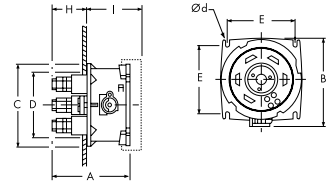

PRODUCT	A	B	C	D	E	H	I	Ød
PFQ	7.64	9.45	7.72	5.51	5.75	2.99	6.89	0.39
PF	8.66	9.84	9.06	7.28	7.48	3.94	8.27	0.39

receptacle on surface box

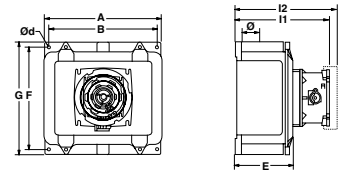

PRODUCT	A	B	E	F	G	I1	I2	Ø	Ød
PFQ/PF	15.70	14.63		13.75	15.15			2.0-4.0	0.41
PFQ	15.70	14.63	8.62	13.75	15.15	13.24	15.74	2.0-4.0	0.41
PF	15.70	14.63	8.81	13.75	15.15	13.68	19.68	2.0-4.0	0.41



DR400

Features and Ratings
DR400A

p. 136
p. 137



High amperage plugs & receptacles with exclusive safety & performance features

DR400 devices are a preferred choice over competitive pin and sleeve devices. They offer maximum performance and durability in a compact form factor. Exclusive features protect workers from electrical hazards and enable relatively easy connection and disconnection. DR400 plugs and receptacles are ideal for shore power, power distribution, generator connections and mining applications.

Main Advantages

- ▶ Exclusive contact technology maximizes performance and durability
- ▶ Safety features protect workers
- ▶ Easy plug insertion and removal

Product Features

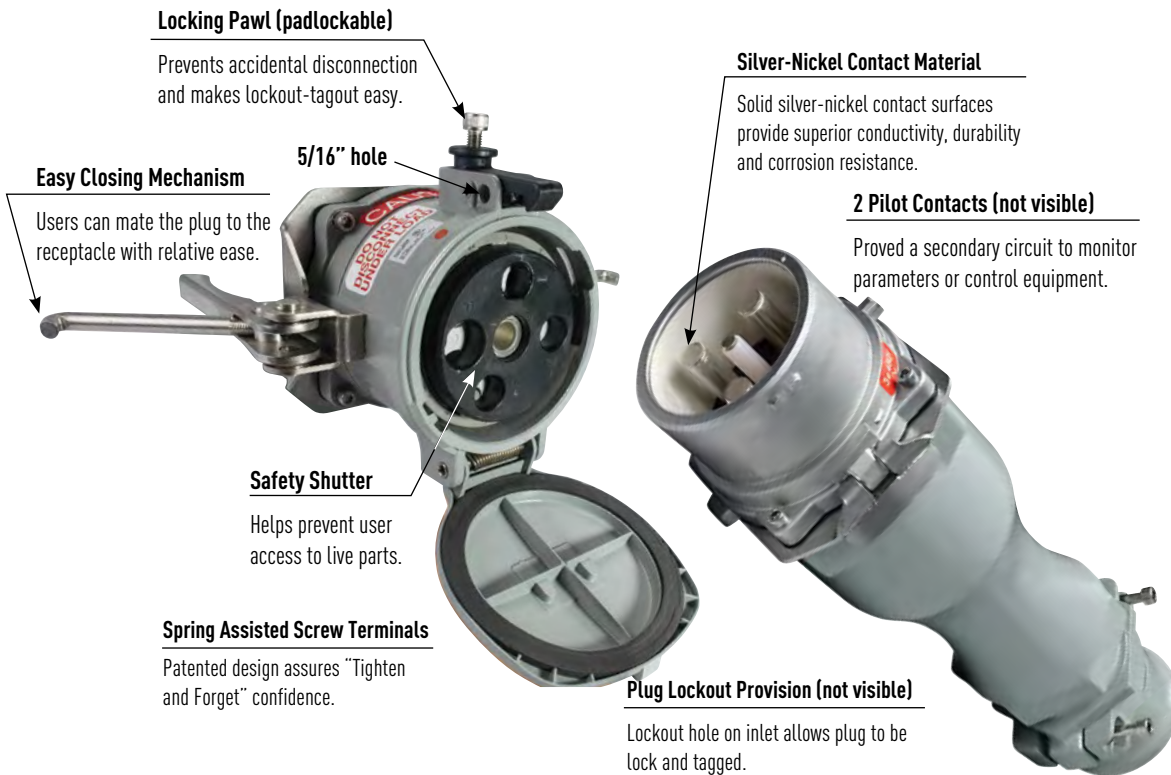

Locking Pawl (padlockable)

Prevents accidental disconnection and makes lockout-tagout easy.

Silver-Nickel Contact Material

Solid silver-nickel contact surfaces provide superior conductivity, durability and corrosion resistance.

2 Pilot Contacts (not visible)

Proved a secondary circuit to monitor parameters or control equipment.

Safety Shutter

Helps prevent user access to live parts.

Spring Assisted Screw Terminals

Patented design assures "Tighten and Forget" confidence.

Plug Lockout Provision (not visible)

Lockout hole on inlet allows plug to be lock and tagged.

Operating Instructions



Partially insert the plug.



Place the closing mechanism around tabs on inlet.



Push the handles up, the plug is fully drawn into the receptacle.



Use the locking tool and turn clockwise to tighten screw.

General Ratings

Amperage	400A to 480 VAC 350A to 600 VAC
Environmental	IP54 (IP66/IP67 optional)
Temperature	min -40°F/max 140°F

Listings

Category	UL	CSA
Plugs and Receptacles	UL 1682	C22.2 No. 182.1

Highlighted Feature

Silver-Nickel, Spring-Loaded Butt-Style Contacts



Solid Silver-Nickel, Spring-Loaded Butt Style Contacts maintain optimal contact pressure and superior conductivity even in dirty, corrosive environments.



Watch the DR400 video and other product videos at meltric.com/video

DSN
DS
DB
MULTIPIN
DR / PN
DC
HIGH AMPACITY

DR400



DR – 400A Standard Duty Plugs & Receptacles

UL/CSA Ratings

- Max Amperage & Voltage**
 400A Max to 480 VAC
 350A Max to 600 VAC
- Current Interruption Capability**
 Not for current interrupting
- Short Circuit Rating**
 18kA
 A withstand test was performed with RK1 current limiting fuses sized at at least 100% of the devices ampacity rating.
- Environmental Ratings IP54/ IP55***
 * IP54 when the plug & receptacle are mated. IP55 on the receptacle alone when the lid is latched closed.
- Temperature Range**
 Min -40°F / Max 140°F
- Wiring Capacity**
 Min 2 AWG Max 350 MCM
 Aux Contacts – 14 AWG (prewired)
- Applicable Standards**
 UL 1682
 CSA 182.1

Receptacle (female)

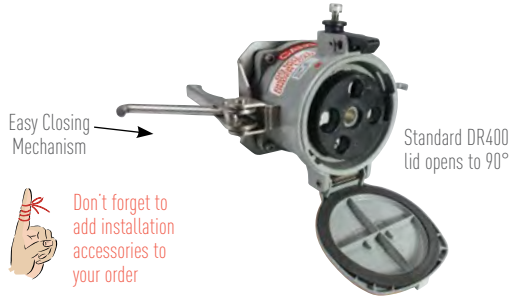

Inlet (male)



North American UL/CSA Configurations

Voltage	Polarity	Part # Metal
208V	3P+G+2PIL	39-44163-172
250V	3P+G+2PIL	39-44073-172
480V	3P+G+2PIL	39-44043-172
600V	3P+G+2PIL	39-44143-172*

Voltage	Polarity	Part # Metal
208V	3P+G+2PIL	39-48163-172
250V	3P+G+2PIL	39-48073-172
480V	3P+G+2PIL	39-48043-172
600V	3P+G+2PIL	39-48143-172*

* 350A only for 600V models.

Other voltage configurations are available – contact customer service at 800.433.7642.

For international configurations and ratings (IEC,CE) visit meltric.com/international-catalog or contact customer service at 800.433.7642.

Key Feature

Standard Locking Pawl



DR400 receptacles are provided with a screw-type locking pawl that prevents accidental disconnections under load.

Receptacle Options	Part #
IP66/IP67	Recept # - 4X
Closed Lid Configuration	Recept # - NC

Inlet Options	Part #
IP66/IP67	Inlet # - 4X
With No Lockout Hole	Inlet # - A155

DR400 Order Example:

To order IP 66/67 watertightness on an inlet and receptacle add -4X to the part numbers.

DR400 Inlet 3P+G+2PIL = 39-48043-172-4X

DR400 Receptacle 3P+G+2PIL = 39-44043-172-4X

Appropriate accessory part numbers must also be included on the order.

See pgs 211-220 for detailed information on these options

Installation Accessories

Handles



NPT Size	Metal Handle	Cable Range	Straight Handle with Bushing
2"	4MH2	2.09-2.25 in	39-4A915-57
2 1/2"	4MH212	2.25-2.44 in	39-4A915-62
3"	4MH3	2.44-2.67 in	39-4A915-68
		2.67-2.87 in	39-4A915-73

Angles

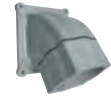

Spacer (included)	Metal Straight* Adapter	Metal 60° Angle
none	39-4A127	-
2.68 in	-	39-4A027-68

Notes: * Use metal straight adapter when mounting directly on a panel.

Junction Boxes



NPT Size	Metal Junction Box
2"	MB40DR-20
2 1/2"	MB40DR-25
3"	MB40DR-30
3 1/2"	MB40DR-35
4"	MB40DR-40

Miscellaneous Accessories



Inlet Cap	Spacer (68 mm)*	Spacer (115 mm)**
31-2A126	39-4A127-68	39-4A127-115

Notes: * 68mm (2.68") spacer is used (included) with metal 60° angle.
** 115mm spacer can be used when mounting to a panel - though the metal straight adapter is preferred.

Dimensions Provided in inches

Dimensions are for reference only and may change depending on accessories used. For precise dimensions contact MELTRIC Engineering.

receptacle

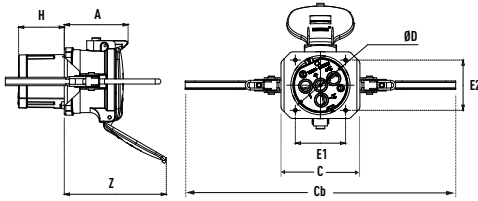

PRODUCT	A	C	Cb	E1	E2	H	Z	ØD
DR400	5.06	6.00	20.61	3.86	3.86	3.29	8.66	4.37

inlet

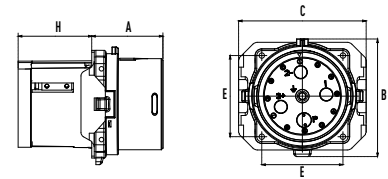

PRODUCT	A	B	C	E	H
DR400	3.48	5.59	6.06	3.86	3.43

connector

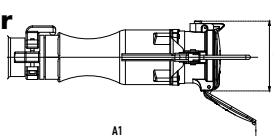

PRODUCT	A1	Y
DR400	24.27	6.47

plug

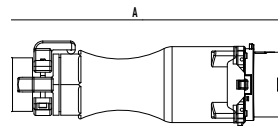

PRODUCT	A
DR400	19.10

receptacle/angle

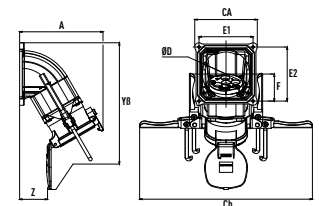

PRODUCT	A	CA	Cb	E1	E2	F	YØ	Z	ØD
DR400	10.00	7.52	20.61	6.50	6.50	3.25	17.70	4.52	5.63



Single pole, high amperage plugs & receptacles

SP devices are designed for safety, durability and ease of operation. SP receptacles are IP 2X rated to prevent accidental finger contact with live parts and are also equipped with pilot contacts for controlling the power circuit. The pilot contacts are interlocked with the latching mechanism to prevent connection or disconnection under load.

Five different mechanical keying positions for L1, L2, L3, N and E prevent accidental insertion of the wrong plug into a receptacle. Color coding simplifies identification of mating devices.

Main Advantages

- ▶ Safety features provide maximum protection
- ▶ Silver, butt-style contact technology maximizes durability
- ▶ IP66/IP67 environmental protection when mated

Product Features

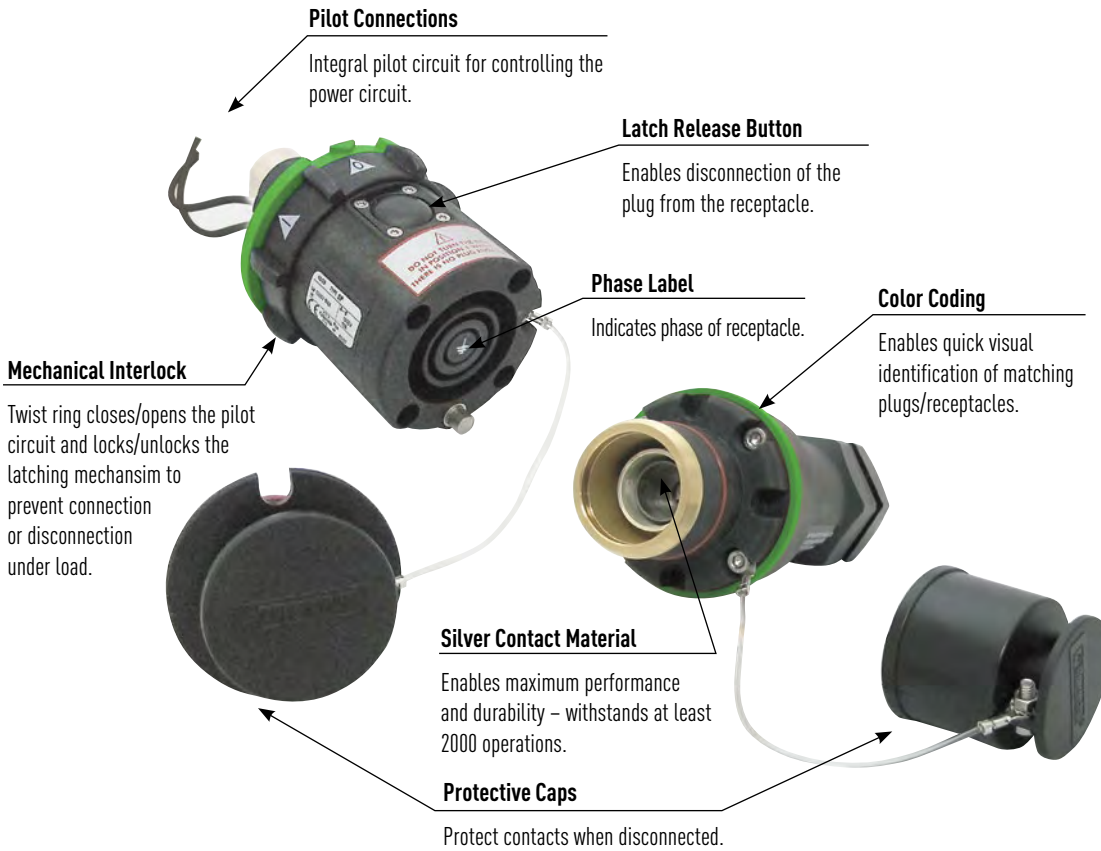

General Ratings

Listing	CSA	IEC
Amperage	600A	700A
Voltage	600 VAC	1000 VAC/1500 VDC Max
Frequency	50-400 Hz	50-400 Hz
Horsepower	500 hp	-
Environmental	IP66/IP67	IP66/IP67
Temperature	min -15°F/max 140°F	min -15°F/max 140°F

Highlighted Feature

Pilot Circuit



SP plugs and connectors are designed with safety and durability in mind. Each device is mechanically interlocked with an integral pilot circuit switch for controlling the power circuit in order to prevent connection and disconnection under load.

A typical pilot circuit wiring diagram

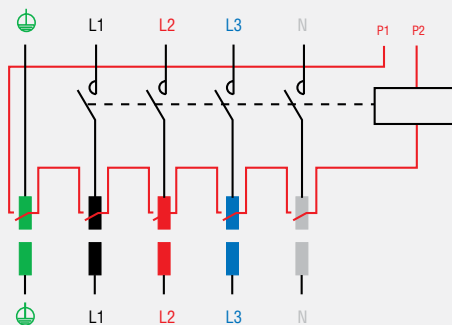

Operating Instructions



To connect, insert the plug into the receptacle until a click is heard. Rotation of the plug in either direction engages a locking finger, which prevents further rotation.



To close the pilot circuit and mechanically lock the plug into the receptacle, turn the ring on the receptacle until the "1" lines up with the arrow. This turns the power on.



To disconnect, open the pilot circuit and unlock the plug by turning the ring until the "0" is aligned with the arrow. The power is now off.



Press firmly on the latch release button and simultaneously pull on the inlet. A slight rotation of the plug may also be required.

SP



SP – 600A

Single Pole Plugs & Receptacles

CSA Ratings

- Max Amperage & Voltage**
 600A, 600 VAC
 Contact customer service to order devices for international applications and for IEC listings up to 700A, 1000 VAC/1500 VDC.
- Current Interruption Capability**
 Non-Load break
- Horsepower Ratings**

480V	3Ø	500 hp
600V	3Ø	500 hp

 CSA HP rated when auxiliary pilots are wired to control motor control circuit.
- Environmental Ratings**
 IP66/IP67
- Temperature Range**
 Min -15°F/Max 140°F
- Wiring Capacity**
 Min 2/0 Max 777 MCM
 Aux Contacts 12-14 AWG
- Applicable Standards**
 CSA 182.1
- Pilot Contact Amperage**
 1A, 240 VAC

Receptacle (female) without lug



Don't forget to add installation accessories to your order

Inlet (male) without lug



North American Configurations

North American Color Code	Polarity	Part # without lug	Color Code	Polarity	Part # without lug
Black	L1	45-44001-P80	Black	L1	45-48001-P80
Red	L2	45-44002-P80	Red	L2	45-48002-P80
Blue	L3	45-44003-P80	Blue	L3	45-48003-P80
White	NEUTRAL	45-4400N-P80	White	NEUTRAL	45-4800N-P80
Green	GROUND	45-4400T-P80	Green	GROUND	45-4800T-P80
Red	POSITIVE	45-4400P	Red	POSITIVE	45-4800P
Black	NEGATIVE	45-4400M	Black	NEGATIVE	45-4800M
Green	GROUND	45-4400T	Green	GROUND	45-4800T

- Notes:**
- Not CSA listed. CE rated up to 700A, 1000 VAC/1500 DC.
 - Pilot contacts are AC/DC rated for 6A and 250V.

IEC/CE Ratings

- Amperage**
 700A
- Voltage**
 1000 VAC, 1500 VDC
- Environmental Ratings**
 IP66/IP67
- Temperature Range**
 Min -40°C/Max 60°C
- Wiring Capacity**
 50 - 400 mm²
- Applicable Standards**
 CE

IEC/CE Configurations

European Color Code	Polarity	Part # without lug	Color Code	Polarity	Part # without lug
Brown	L1	45-44001	Brown	L1	45-48001
Black	L2	45-44002	Black	L2	45-48002
Grey	L3	45-44003	Grey	L3	45-48003
Blue	NEUTRAL	45-4400N	Blue	NEUTRAL	45-4800N
Green	EARTH	45-4400T	Green	EARTH	45-4800T
Red	POSITIVE	45-4400P	Red	POSITIVE	45-4800P
Black	NEGATIVE	45-4400M	Black	NEGATIVE	45-4800M

- Notes:**
- Not CSA listed. CE rated up to 700A, 1000 VAC/1500 DC.
 - Pilot contacts are AC/DC rated for 6A and 250V.

Installation Accessories

Crimping lug*



(Bolt Included)

Handle



Flexible MCM+ Wire Size	Straight with Terminal	Straight Threaded**	Cable Outside Diameter	Part #
1	45-4A50C	45-4A50D	.750 - .875	45-4A753-A
2/0	45-4A70C	45-4A70D	.875 - 1.000	45-4A753-B
3/0	45-4A95C	45-4A95D	1.000 - 1.125	45-4A753-C
250	45-4A12C	45-4A12D	1.125 - 1.250	45-4A753-D
300	45-4A15C	45-4A15D	1.250 - 1.375	45-4A753-E
350	45-4A18C	45-4A18D	1.250 - 1.375	45-4A783-A
450	45-4A24C	45-4A24D	1.312 - 1.437	45-4A783-B
600	45-4A30C	45-4A30D	1.438 - 1.562	45-4A783-C
777	45-4A40C	45-4A40D	1.562 - 1.688	45-4A783-D

Inclined Metal Angle 45°
45-4A027

* Use the straight threaded lug when cord mounting with handle accessory.
 + Based on flexible type copper cables. See appropriate NEC tables for applicable ampacities.

** Conductor sizes are approximations based on metric wire size conversions.

Dimensions Inlet/Receptacle – Provided in inches

Dimensions are for reference only and may change depending on accessories used. For precise dimensions contact MELTRIC Engineering.

inlet

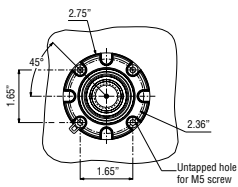

receptacle

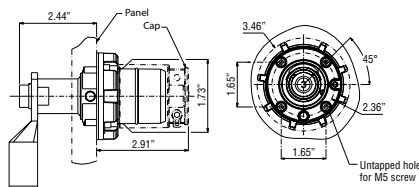

plug

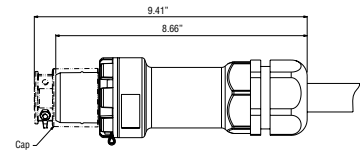

connector

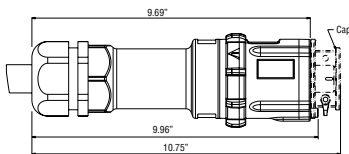

plug / connector

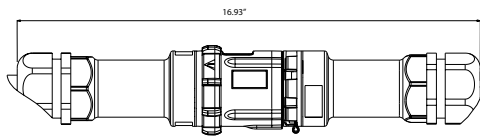

plug with connector on/off

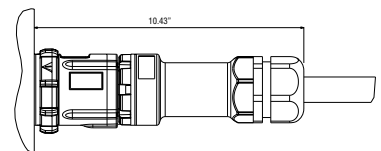

connector with plug on/off

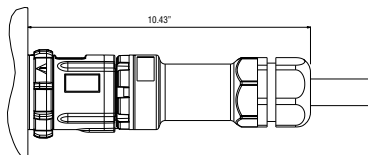

45° inclined receptacle / angle with plug

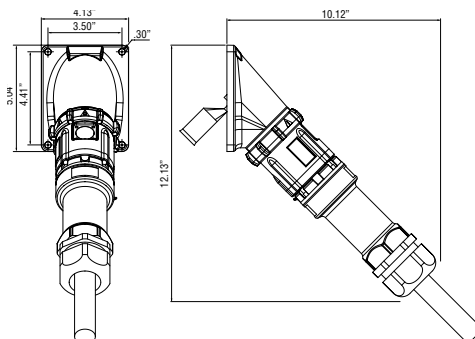

45° inclined inlet / angle with connector

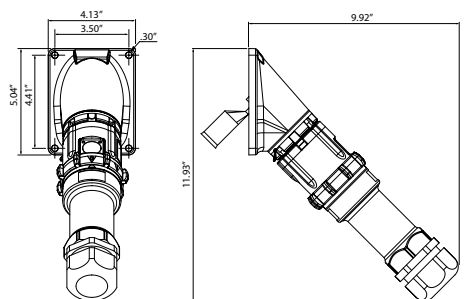

CS1000



Features and Ratings p. 144

CS1000 p. 145

Dimensions p. 146



Single pole power connectors

The CS1000 devices are designed to be a new industry standard for safety, usability, reliability, performance and durability. The CS1000 Series provides safety features that are not currently offered by other single pole devices. These safety features include: IP2X finger protection that protects users from live parts, mechanical keying system prevents insertion of the wrong phases, a locking pin that prevents accidental disconnection, and a plug/receptacle that accepts different cable sizes. The standard features of CS1000 Series include solid silver-nickel contacts, spring-loaded, butt-style contact technology and IP66/IP67 environmental protection.

Main Advantages

- ▶ High Amperage Capacity up to 400A at 600VAC, 600VDC (in North America) or 1000VAC, 1500VDC (in Europe - CE rated).
- ▶ Safety features protect users from live parts and prevent unwanted disconnection.
- ▶ Silver-nickel butt contacts provide superior performance and corrosion resistance.

Product Features

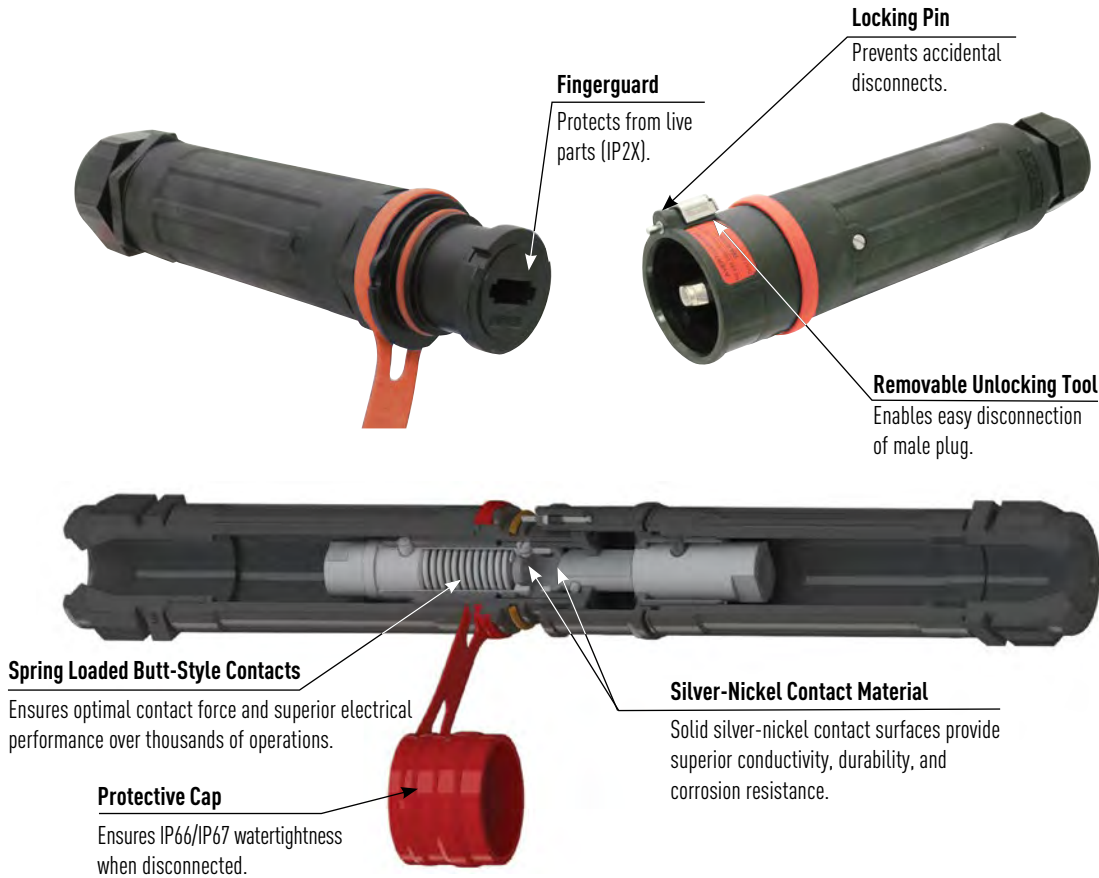

General Ratings

Amperage	400A
Voltage	1000 VAC, 1500 VDC
Frequency	50-400 Hz
Environmental	IP66/IP67
Temperature	min -40°F/max 140°F

* CS1000 plugs and receptacles are UL listed in accordance with UL 1691. CS1000 devices are for use in non-load break applications up to 400A at 600VAC, 600VDC (in North America) or 1000VAC, 1500VDC (in Europe - CE rated).

Listings

Category	UL	CSA	IEC
Receptacles for Plugs and Attachment Plugs	UL 1691	CSA 1691-12	60309-1

Highlighted Feature

5 Mechanical Keying Positions
(North America color codes shown.)



Operating Instructions

Connection



Disconnection





CS1000 – 400A - 1000 VAC Standard Duty Plugs & Receptacles

UL Ratings

- **Amperage**
400A
Not for Current Interrupting
- **Voltage**
600 VAC, 600 VDC
- **Short Circuit Rating**
10kA Withstand
Testing was performed with RK1 current limiting fuses sized at at least 100% of the devices ampacity rating.
- **Environmental Ratings** IP66/
IP67
- **Temperature Range**
Min -40°F / Max 140°F
- **Wiring Capacity**
Min 1 / 0 AWG / Max 450 MCM
90°C rated wire must be used
- **Applicable Standards**
UL 1691
CSA 1691-12

Receptacle (female) without lug



Don't forget to add installation accessories to your order



Inlet (male) without lug



North American Configurations

North American Color Code	Polarity	Part # without lug
	L1	45-34001-P80
	L2	45-34002-P80
	L3	45-34003-P80
	NEUTRAL	45-3400N-P80
	GROUND	45-3400T-P80
	POSITIVE	45-3400P-P80
	NEGATIVE	45-3400M-P80

North American Color Code	Polarity	Part # without lug
	L1	45-38001-P80
	L2	45-38002-P80
	L3	45-38003-P80
	NEUTRAL	45-3800N-P80
	GROUND	45-3800T-P80
	POSITIVE	45-3800P-P80
	NEGATIVE	45-3800M-P80

IEC/CE Ratings

- **Amperage**
400A
Not for Current Interrupting
- **Voltage**
1000 VAC, 1500 VDC
- **Environmental Ratings**
IP66/IP67
- **Temperature Range**
Min -40°F / Max 140°F
- **Wiring Capacity**
Min 1 / 0 AWG / Max 450 MCM
- **Applicable Standards**
CE

IEC/CE Configurations

European Color Code	Polarity	Part # without lug
	L1	45-34001
	L2	45-34002
	L3	45-34003
	NEUTRAL	45-3400N
	GROUND	45-3400T
	POSITIVE	45-3400P
	NEGATIVE	45-3400M

European Color Code	Polarity	Part # without lug
	L1	45-38001
	L2	45-38002
	L3	45-38003
	NEUTRAL	45-3800N
	GROUND	45-3800T
	POSITIVE	45-3800P
	NEGATIVE	45-3800M

Installation Accessories

Angles



w/Adapter Plate

Angle 30°

45-3A027



Required for mounting on panels, walls, etc.

Adapter Plate

45-3A540

Accessories



Inlet Cap

45-3A126



Unlocking Tool *

45-3A396



Padlocking Tool

45-3A843

* One unlocking tool on a "valet" style separable key ring is included with each male inlet.

Installation Accessories

Crimping lug



Use with angle 30° or direct mount

Use with handle or angle

Conductor Size	Allowable Current (A)	Internal Diameter (in)	Straight w/Terminal	Straight Threaded
1/0 ²	200	.43	45-3A50C	45-3A50D
2/0	250	.52	45-3A70C	45-3A70D
3/0	275			
4/0	300	.58	45-3A95C	45-3A95D
		.63	45-3A12C	45-3A12D
250	325	.80	45-4A18C	45-4A18D
350	350			
450	400	.90	45-4A24C	45-4A24D

1 Lugs to be crimped with Greenlee EK6DL11 Crimping Tool Dieless 120V CHR.G.
 2 The ground conductor for the CS1000 series devices shall be limited to a maximum size of 1/0 AWG.

Handle



Normal Duty
100 lb grip

Cable Outside Diameter	Part #
.550 - 1.000	45-3A753
.700 - 1.260	45-3A783

Handle w/Cord Grip (Mesh)



Heavy Duty
300 lb grip

Cable Outside Diameter	Part #
.500 - .625	45-3A753-A
.562 - .688	45-3A753-B
.625 - .750	45-3A753-C
.688 - .812	45-3A753-D
.750 - .875	45-3A753-E
.875 - 1.000	45-3A783-A
1.000 - 1.125	45-3A783-B
1.125 - 1.250	45-3A783-C
1.250 - 1.375	45-3A783-D

Dimensions Provided in inches

Dimensions are for reference only and may change depending on accessories used. For precise dimensions contact MELTRIC Engineering.

receptacle

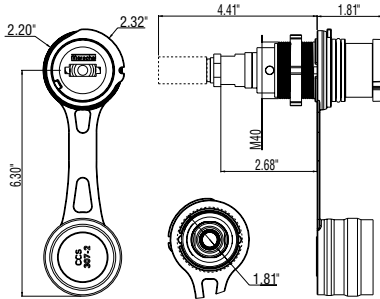

plug/receptacle

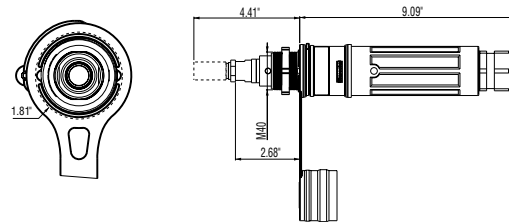

inline connector

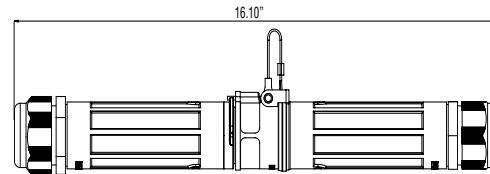

30° inclined receptacle/angle

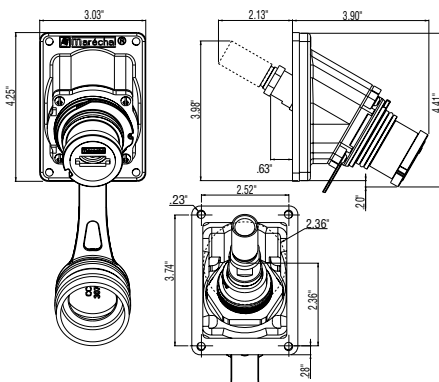

30° receptacle/angle with plug

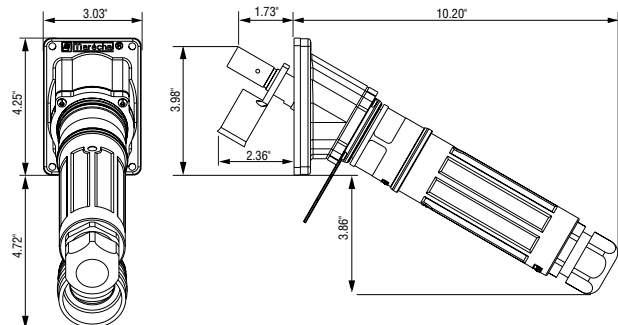

Power Distribution



Custom Power Distribution

p. 149

Rubber Boxes

p. 151

Integral Circuit Protection Wall Boxes

p. 155

Disconnect Combinations

p. 161



Power Distribution

MELTRIC manufactures a wide variety of specialty products to fit specific application needs and to help users benefit from the advantages of MELTRIC's Switch-Rated plugs and receptacles where ever connections may need to be made and broken.

Main Advantages

- ▶ Provide switch-rated safety wherever connections are made
- ▶ Provide convenience and visual verification of deenergization

Power Distribution



Custom Power Distribution

MELTRIC can provide a wide range of power distribution packages built specifically to customer needs.

See pages 149-150



Rubber Boxes

Rubber Power Distribution Boxes are offered in both standard and custom configurations. These boxes will provide a compact, durable solution for portable power distribution needs. Convenient size and shape makes it easy to move around job site.

See pages 151-154



Integral Circuit Protection Wall Boxes

Receptacle/wall box combinations with integral circuit protection combine the safety of a MELTRIC DSN series switch rated receptacle with the convenience of local circuit protection in a compact package. The receptacle is premounted to the box and wired to the circuit protection device for easy installation.

See pages 155-160



Disconnect Combinations

MELTRIC's non-interlocked safety switch disconnects are intended for use in power supply applications where additional over current and short circuit protection is desired.

See pages 161-162



Custom Power Distribution

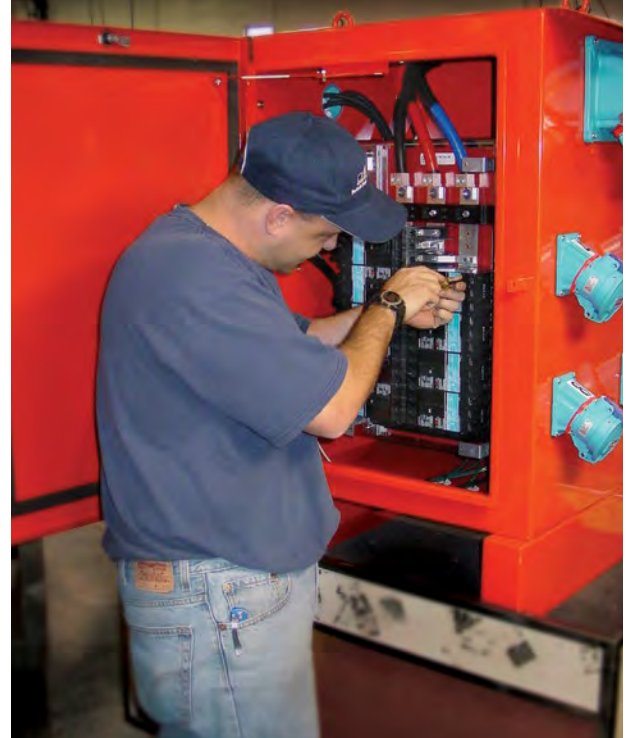

Custom power solutions from MELTRIC provide the switch-rated safety and durability of MELTRIC Deconnector™ Series plugs and receptacles in a power distribution package built specifically to customer needs. Whether you require power distribution in a vertical stand configuration, a low profile horizontal configuration, a custom configuration, or as a cordset; MELTRIC's engineering team can build a package to meet your needs.

Available Features:

MA Rated Enclosures	Rain Hoods
GFCI Protection	Timers
Color Coded Enclosures	Pilot Circuits
Phase Indication	Wheel Kits
Stainless Steel Enclosures	Shunt Trips
120V Convenience Outlet	Under Voltage Trips
	Lifting Provisions
	Power Transformers



Common Platforms

POWER



Power/Transformer Assembly



Vertical Power



Horizontal Multigang



Spider Cart Assembly



Rubber Box



Portable Panel Assembly



Wall Mounted Panel Assembly



Cable Assembly



Breaker Plate Assembly

If you don't see what you are looking for, call MELTRIC @ 800.433.7642



Power Distribution Rubber Boxes

UL Type 3R Enclosures



1 Tier

3 Tier

2 Tier

Choose from standard configurations on pages 152-154 or contact MELTRIC at 800.433.7642 for customized configurations.

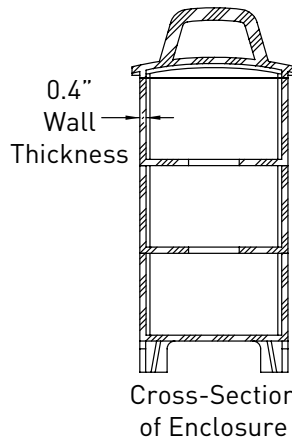
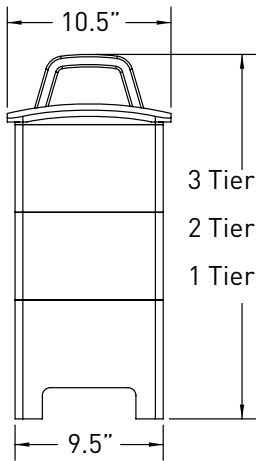

Power Input up to 100A:
Choose a mounted inlet
or a cord & plug.



Mounted Inlet



Cord & Plug

Power Receptacles

Circuit Protection

Convenience Outlets



Room for (2) DSN60 (or smaller) receptacles per side per tier.



Room for up to (10) poles of standard MCB's (mini circuit breakers) per tier.



Room for (2) Type 5-20R duplex receptacles per side per tier or choose other convenience outlets.

1 Tier Rubber Power Distribution Boxes

Configuration T1-C1

Notes: Two receptacles share a 3P breaker.



Side 1

(2) DSN Receptacles



Side 2

(2) 3 Pole MCB's*



Side 3

(2) DSN Receptacles



Side 4

(1) Inlet

Voltage	Contacts	Part #'s: Configuration T1-C1-20A	Part #'s: Configuration T1-C1-30A	Part #'s: Configuration T1-C1-60A
		20A DSN Recepts & 30A DSN Inlet	30A DSN Recepts & 60A DSN Inlet	60A DSN Recepts & 100A DS100C Inlet
	3P+N+G	RBT1-C1-167-20A	RBT1-C1-167-30A	RBT1-C1-167-60A
	3P+N+G	RBT1-C1-077-20A	RBT1-C1-077-30A	RBT1-C1-077-60A
	3P+G	RBT1-C1-043-20A	RBT1-C1-043-30A	RBT1-C1-043-60A

Configuration T1-C2



Side 1

(1) DSN Receptacle
(1) 20A Type 5-20 Duplex GFCI



Side 2

(2) 3 Pole MCB's*
(2) 20A 1 Pole MCB's



Side 3

(1) DSN Receptacle
(1) 20A Type 5-20 Duplex GFCI



Side 4

(1) Inlet

Voltage	Contacts	Part #'s: Configuration T1-C2-20A	Part #'s: Configuration T1-C2-30A	Part #'s: Configuration T1-C2-60A
		20A DSN Recepts & 30A DSN Inlet	30A DSN Recepts & 60A DSN Inlet	60A DSN Recepts & 100A DS100C Inlet
	3P+N+G	RBT1-C2-167-20A	RBT1-C2-167-30A	RBT1-C2-167-60A
	3P+N+G	RBT1-C2-077-20A	RBT1-C2-077-30A	RBT1-C2-077-60A

Configuration T1-C3



Side 1

(1) DSN 30A Receptacle
(1) DSN 20A Receptacle



Side 2

(2) 30A 3 Pole MCB
(1) 20A 3 Pole MCB



Side 3

(1) DSN 30A Receptacle
(1) DSN 20A Receptacle



Side 4

(1) DSN 60A Inlet

Voltage	Contacts	Part #'s: Configuration T1-C3
		20/30A DSN Recepts & 60A DSN Inlet
	3P+N+G	RBT1-C3-167
	3P+N+G	RBT1-C3-077
	3P+G	RBT1-C3-043

Notes: 30A receptacles are protected by individual 30A breakers. 20A receptacles share a 20A breaker.

* Ampacity ratings of MCB's match the receptacles they protect.



2 Tier Rubber Power Distribution Boxes

Configuration T2-C1



Side 1

- (1) DSN 30A Receptacle
- (1) DSN 20A Receptacle
- (1) DSN 60A Receptacle



Side 2

- (2) 30A 3 Pole MCB's
- (2) 20A 3 Pole MCB's
- (2) 60A 3 Pole MCB's
- (2) 20A 1 Pole MCB's



Side 3

- (1) DSN 30A Receptacle
- (1) DSN 20A Receptacle
- (1) DSN 60A Receptacle



Side 4

- (2) 20A Type 5-20 Duplex GFCI
- (1) DS100C 100A Inlet

		Part #'s: Configuration T2-C1	
		20/30/60A DSN Receptacles & 100A DS100C Inlet	
Voltage	Contacts		
120/208V	3P+N+G	RBT2-C1-167	
125/250V	3P+N+G	RBT2-C1-077	

Configuration T2-C2



Side 1

- (4) DSN Receptacles



Side 2

- (4) 3 Pole MCB's*
- (2) 20A 1 Pole MCB's



Side 3

- (4) DSN Receptacles



Side 4

- (2) 20A Type 5-20 Duplex GFCI
- (1) DS100C 100A Inlet

		Part #'s: Configuration T2-C2-20A	Part #'s Configuration T2-C2-30A
		20A DSN Receptacles & 100A DS100C Inlet	30A DSN Receptacles & 100A DS100C Inlet
Voltage	Contacts		
120/208V	3P+N+G	RBT2-C2-167-20A	RBT2-C2-167-30A
125/250V	3P+N+G	RBT2-C2-077-20A	RBT2-C2-077-30A

* Ampacity ratings of MCB's match the receptacles they protect.

3 Tier Rubber Power Distribution Boxes

Configuration T3-C1



Side 1

- (1) 20A Type 5-20 Duplex GFCI
- (2) DSN 20A Receptacles
- (2) DSN 30A Receptacles



Side 2

- (6) 20A 1 Pole MCB's
- (4) 20A 3 Pole MCB's
- (4) 30A 3 Pole MCB's



Side 3

- (1) 20A Type 5-20 Duplex GFCI
- (2) DSN 20A Receptacles
- (2) DSN 30A Receptacles



Side 4

- (4) 20A Type 5-20 Duplex GFCI
- (1) DS100C 100A Inlet

		Part #'s: Configuration T3-C1	
		20A & 30A DSN Receptacles & 100A DS100C Inlet	
Voltage	Contacts		
120/208V	3P+N+G	RBT3-C1-167	
125/250V	3P+N+G	RBT3-C1-077	

Configuration T3-C2



Side 1

- (4) DSN 20 or (4) 30A Receptacles
- (1) DSN 60A Receptacle



Side 2

- (4) 3 Pole MCB's*
- (2) 60A 3 Pole MCB's
- (4) 20A 1 Pole MCB's



Side 3

- (4) DSN 20 or (4) 30A Receptacles
- (1) DSN 60A Receptacle



Side 4

- (4) 20A Type 5-20 Duplex GFCI
- (1) DS100C 100A Inlet

		Part #'s: Configuration T3-C2-20A		Part #'s: Configuration T3-C2-30A	
		20A & 60A DSN Receptacles & 100A DS100C Inlet		30A & 60A DSN Receptacles & 100A DS100C Inlet	
Voltage	Contacts				
120/208V	3P+N+G	RBT3-C2-167-20A		RBT3-C2-167-30A	
125/250V	3P+N+G	RBT3-C2-077-20A		RBT3-C2-077-30A	

* Ampacity ratings of MCB's match the receptacles they protect.



Receptacles & Wall Boxes with Integral Circuit Protection



MELTRIC's receptacle/wall box combinations with integral circuit protection combine the safety of a MELTRIC DSN series switch-rated receptacle with the convenience of local circuit protection in a compact package. The receptacle is premounted to the box and wired to the circuit protection device for easy installation.

Models are available with or without a viewing window and in either painted mild steel or stainless steel enclosures. The 20A and 30A models are available and equipped with fuse holders or mini-circuit breakers and the 60A models are available with fuseholders or supplementary protectors.

Fuseholder Equipped Models



MELTRIC's DSN Decontactor™ Series switch-rated plugs and receptacles are UL rated to withstand and close-into short circuit currents up to 100kA in circuits protected by RK1 current limiting fuses or other fuses with lower let through energy like Class CC and Class J fuses. This allows users to take advantage of the DSN's capabilities in applications where higher fault currents are not already protected with the required fusing.

Fuseholder models feature Ferraz Shawmut Ultra-Safe Fuse Holders (UL 512 / IEC 269). The fuseholders have a blown fuse indicator light for each pole and pivot open for easy and finger safe fuse replacement. Fuses are not provided. They should be selected for the specific application.

Circuit Breaker Equipped Models



Circuit-breaker equipped models allow users to provide overload protection in a convenient location near the application. The 20A & 30A models feature Eaton WMZT miniature circuit breakers (UL 489) and the 60A models use Eaton WMZS supplementary protectors (UL 1077). All are provided standard with a 'C' trip curve. A 'D' trip curve for the 20A and 30A breakers, and a 'B' trip curve for the 60A supplementary protectors are also available as options.

Trip Curve Characteristics

"B" Curve:	The protective device will instantaneously trip @ 3X to 5X its rated current
"C" Curve:	The protective device will instantaneously trip @ 5X to 10X its rated current
"D" Curve:	The protective device will instantaneously trip @ 10X to 20X its rated current

Enclosures

The wall boxes are Hoffman InLine® series enclosures.

Dimensions: **20A/30A Fuse Holder/Circuit Breaker**

Box exteriors = 9.84" x 7.87" x 5.91" (250mm x 200mm x 150mm).

Mounting footprint = 12.5" x 8" including the pre-installed mounting brackets.

60A Supplementary Circuit Breaker

Box exteriors = 9.84" x 7.87" x 5.91" (250mm x 200mm x 150mm).

Mounting footprint = 12.5" x 8" including the pre-installed mounting brackets.

60A Fuse Holder

Box exteriors = 11.81" x 9.84" x 5.91" (300mm x 250mm x 150mm).

Mounting footprint = 14.4" x 9.8" including the pre-installed mounting brackets.

Box Materials: Mild steel boxes are 16 gauge, stainless steel boxes are 14 gauge type 304.

Available door windows are 3/16" clear polycarbonate.

Latch: Quarter turn slotted stainless steel design for easy operation and durability.

Finish: Mild steel boxes are painted with a light gray textured polyester powdercoat.
Stainless Steel boxes have a #4 brushed finish.

Environmental: Mild steel boxes are NEMA Type 4 and 12 .
Stainless steel boxes are NEMA Type 4, 4X and 12.



Circuit Protected Receptacles

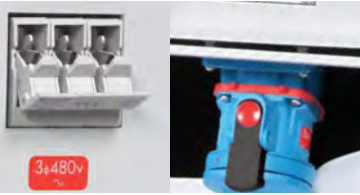

Mild Steel Boxes with Ultra-Safe Fuse Holders

Ratings

- Voltage**
 20A: 480 VAC
 30A: 600 VAC
 60A: 600 VAC
- Environmental Ratings**
 Overall: NEMA Type 4
 Box: NEMA Type 4, 12
 Receptacle: NEMA Type 4X
- Temperature Range**
 Min -40°F / Max 140°F
- Listings**
 Box: UL 508A
 Receptacle: UL 2682, UL 1682, CSA 22.2 No. 182.1, IEC 60309-1
 Fuseholder: UL 512, IEC 269

Standard Box



Box with Viewing Window



North American UL/CSA Configurations

Voltage	Polarity	Part #			Part #		
		20A	30A	60A	20A	30A	60A
120V	1P+N+G	FB-63-14165	FB-63-34165	FB-63-64165	FBW-63-14165	FBW-63-34165	FBW-63-64165
120/208V	3P+N+G	FB-63-14167	FB-63-34167	FB-63-64167	FBW-63-14167	FBW-63-34167	FBW-63-64167
125V	1P+N+G	FB-63-14075	FB-63-34075	FB-63-64075	FBW-63-14075	FBW-63-34075	FBW-63-64075
125/250V	2P+N+G	FB-63-14076	FB-63-34076	FB-63-64076	FBW-63-14076	FBW-63-34076	FBW-63-64076
208V	2P+G	FB-63-14162	FB-63-34162	FB-63-64162	FBW-63-14162	FBW-63-34162	FBW-63-64162
208V	3P+G	FB-63-14163	FB-63-34163	FB-63-64163	FBW-63-14163	FBW-63-34163	FBW-63-64163
250V	2P+G	FB-63-14072	FB-63-34072	FB-63-64072	FBW-63-14072	FBW-63-34072	FBW-63-64072
250V	3P+G	FB-63-14073	FB-63-34073	FB-63-64073	FBW-63-14073	FBW-63-34073	FBW-63-64073
277V	1P+N+G	FB-63-14045	FB-63-34045	FB-63-64045	FBW-63-14045	FBW-63-34045	FBW-63-64045
277/480V	3P+N+G	FB-63-14047	FB-63-34047	FB-63-64047	FBW-63-14047	FBW-63-34047	FBW-63-64047
347/600V	3P+N+G	FB-63-14147	FB-63-34147	FB-63-64147	FBW-63-14147	FBW-63-34147	FBW-63-64147
480V	2P+G	FB-63-14042	FB-63-34042	FB-63-64042	FBW-63-14042	FBW-63-34042	FBW-63-64042
480V	3P+G	FB-63-14043	FB-63-34043	FB-63-64043	FBW-63-14043	FBW-63-34043	FBW-63-64043
600V	2P+G	FB-63-14142	FB-63-34142	FB-63-64142	FBW-63-14142	FBW-63-34142	FBW-63-64142
600V	3P+G	FB-63-14143	FB-63-34143	FB-63-64143	FBW-63-14143	FBW-63-34143	FBW-63-64143

For international configurations and ratings (IEC, CE) visit meltric.com/international-catalog or contact customer service at 800.433.7642.

Main Options

- 
Auxiliary Contacts
- 
Mushroom Pawl
- 
Padlock Pawl
- 
Closed Lid Configuration
 Lid springs to a mostly closed, pre-latch position.

Receptacle Options

Part

- With 2 auxiliary contacts (30A only) Part # - 972
- Mushroom Pawl Part # - 375
- Padlock Pawl Part # - 843
- Closed lid configuration Part # - NC



*Ferraz Shawmut 30A, 600V Ultra-Safe Fuse Holders for 1/2 Class CC fuses are standard. They include a blown fuse indicator for each pole. Fuses are not included.

See pgs 211-220 for detailed information on these options

Stainless Steel Boxes with Ultra-Safe Fuse Holders

Standard Box



Box with Viewing Window



North American UL/CSA Configurations

Voltage Polarity	Part #			Part #		
	20A	30A	60A	20A	30A	60A
120V 1P+N+G	FBSS-63-14165	FBSS-63-34165	FBSS-63-64165	FBWSS-63-14165	FBWSS-63-34165	FBWSS-63-64165
120/208V 3P+N+G	FBSS-63-14167	FBSS-63-34167	FBSS-63-64167	FBWSS-63-14167	FBWSS-63-34167	FBWSS-63-64167
125V 1P+N+G	FBSS-63-14075	FBSS-63-34075	FBSS-63-64075	FBWSS-63-14075	FBWSS-63-34075	FBWSS-63-64075
125/250V 2P+N+G	FBSS-63-14076	FBSS-63-34076	FBSS-63-64076	FBWSS-63-14076	FBWSS-63-34076	FBWSS-63-64076
208V 2P+G	FBSS-63-14162	FBSS-63-34162	FBSS-63-64162	FBWSS-63-14162	FBWSS-63-34162	FBWSS-63-64162
208V 3P+G	FBSS-63-14163	FBSS-63-34163	FBSS-63-64163	FBWSS-63-14163	FBWSS-63-34163	FBWSS-63-64163
250V 2P+G	FBSS-63-14072	FBSS-63-34072	FBSS-63-64072	FBWSS-63-14072	FBWSS-63-34072	FBWSS-63-64072
250V 3P+G	FBSS-63-14073	FBSS-63-34073	FBSS-63-64073	FBWSS-63-14073	FBWSS-63-34073	FBWSS-63-64073
277V 1P+N+G	FBSS-63-14045	FBSS-63-34045	FBSS-63-64045	FBWSS-63-14045	FBWSS-63-34045	FBWSS-63-64045
277/480V 3P+N+G	FBSS-63-14047	FBSS-63-34047	FBSS-63-64047	FBWSS-63-14047	FBWSS-63-34047	FBWSS-63-64047
347/600V 3P+N+G	FBSS-63-14147	FBSS-63-34147	FBSS-63-64147	FBWSS-63-14147	FBWSS-63-34147	FBWSS-63-64147
480V 2P+G	FBSS-63-14042	FBSS-63-34042	FBSS-63-64042	FBWSS-63-14042	FBWSS-63-34042	FBWSS-63-64042
480V 3P+G	FBSS-63-14043	FBSS-63-34043	FBSS-63-64043	FBWSS-63-14043	FBWSS-63-34043	FBWSS-63-64043
600V 2P+G	FBSS-63-14142	FBSS-63-34142	FBSS-63-64142	FBWSS-63-14142	FBWSS-63-34142	FBWSS-63-64142
600V 3P+G	FBSS-63-14143	FBSS-63-34143	FBSS-63-64143	FBWSS-63-14143	FBWSS-63-34143	FBWSS-63-64143

For international configurations and ratings (IEC, CE) visit meltric.com/international-catalog or contact customer service at 800.433.7642.

Receptacle Options	Part #
With 2 auxiliary contacts (30A only)	Recept # - 972
Mushroom Pawl	Recept # - 375
Padlock Pawl	Recept # - 843
Closed lid configuration	Recept # - NC



*Ferraz Shawmut 30A, 600V Ultra-Safe Fuse Holders for Class CC fuses are standard. They include a blown fuse indicator for each pole. Fuses are not included.

Ratings

- Voltage**
20A: 480 VAC
30A: 600 VAC
60A: 600 VAC
- Environmental Ratings**
Overall: NEMA Type 4X
Box: NEMA Type 4X, 12
Receptacle: NEMA Type 4X
- Temperature Range**
Min -40°F / Max 140°F
- Listings**
Box: UL 508A
Receptacle: UL 2682, UL 1682, CSA 22.2 No. 182.1, IEC 60309-1
Fuseholder: UL 512, IEC 269

Main Options

-  **Auxiliary Contacts**
-  **Emergency Stop Pawl**
-  **Padlock Pawl**
-  **Closed Lid Configuration**
Lid springs to a mostly closed, prelatch position.

See pgs 211-220 for detailed information on these options

Circuit Protected Receptacles



Mild Steel Boxes with Circuit Breakers

Ratings

- Voltage**
480 VAC
- Environmental Ratings**
Overall: NEMA Type 4
Box: NEMA Type 4, 12
Receptacle: NEMA Type 4X
- Temperature Range**
Min -40°F / Max 140°F for 20A & 30A
Min 23°F / Max 104°F for 60A
- Listings**
Box: UL 508A
Receptacle: UL 2682, UL 1682, CSA 22.2 No. 182.1, IEC 60309-1
Breaker: UL 489 for 20A & 30A, UL 1077 for 60A

Standard Box



Box with Viewing Window



North American UL/CSA Configurations

Voltage	Polarity	Part #			Part #		
		20A	30A	60A	20A	30A	60A
120V	1P+N+G	CB-63-14165	CB-63-34165	CB-63-64165	CBW-63-14165	CBW-63-34165	CBW-63-64165
120/208V	3P+N+G	CB-63-14167	CB-63-34167	CB-63-64167	CBW-63-14167	CBW-63-34167	CBW-63-64167
125V	1P+N+G	CB-63-14075	CB-63-34075	CB-63-64075	CBW-63-14075	CBW-63-34075	CBW-63-64075
125/250V	2P+N+G	CB-63-14076	CB-63-34076	CB-63-64076	CBW-63-14076	CBW-63-34076	CBW-63-64076
208V	2P+G	CB-63-14162	CB-63-34162	CB-63-64162	CBW-63-14162	CBW-63-34162	CBW-63-64162
208V	3P+G	CB-63-14163	CB-63-34163	CB-63-64163	CBW-63-14163	CBW-63-34163	CBW-63-64163
250V	2P+G	CB-63-14072	CB-63-34072	CB-63-64072	CBW-63-14072	CBW-63-34072	CBW-63-64072
250V	3P+G	CB-63-14073	CB-63-34073	CB-63-64073	CBW-63-14073	CBW-63-34073	CBW-63-64073
277V	1P+N+G	CB-63-14045	CB-63-34045	CB-63-64045	CBW-63-14045	CBW-63-34045	CBW-63-64045
277/480V	3P+N+G	CB-63-14047	CB-63-34047	CB-63-64047	CBW-63-14047	CBW-63-34047	CBW-63-64047
480V	2P+G	CB-63-14042	CB-63-34042	CB-63-64042	CBW-63-14042	CBW-63-34042	CBW-63-64042
480V	3P+G	CB-63-14043	CB-63-34043	CB-63-64043	CBW-63-14043	CBW-63-34043	CBW-63-64043

For international configurations and ratings (IEC,CE) visit meltric.com/international-catalog or contact customer service at 800.433.7642.

Main Options



Auxiliary Contacts



Mushroom Pawl



Padlock Pawl



Closed Lid Configuration
Lid springs to a mostly closed, pre-latch position.

Receptacle Options

Part

With 2 auxiliary contacts (30/60A only)	Part # - 972
With 3 auxiliary contacts (60A only)	Part # - 973*
With 4 auxiliary contacts (60A only)	Part # - 974*
Mushroom Pawl	Part # - 375
Padlock Pawl	Part # - 843
Closed lid configuration	Part # - NC

Notes: + Not UL/CSA Listed

Circuit Protection Options

Part

'D' Trip Curve (20/30A only)	Part # - D
'B' Trip Curve (60A only)	Part # - B
Standard circuit protectors include a 'C' trip curve.	
20A: Eaton 20A, 480V 'WMZT' circuit breaker*	
30A: Eaton 30A, 480V 'WMZT' circuit breaker*	
60A: Eaton 63A, 480V 'WMZS' supplementary protector**	

* or equivalent UL 489 circuit breaker

** or equivalent UL 1077 supplementary protector



See pgs 211-220 for detailed information on these options

Stainless Steel Boxes with Circuit Breakers

Standard Box



Box with Viewing Window



North American UL/CSA Configurations

Voltage	Polarity	Part #			Part #		
		20A	30A	60A	20A	30A	60A
120V	1P+N+G	CBSS-63-14165	CBSS-63-34165	CBSS-63-64165	CBWSS-63-14165	CBWSS-63-34165	CBWSS-63-64165
120/208V	3P+N+G	CBSS-63-14167	CBSS-63-34167	CBSS-63-64167	CBWSS-63-14167	CBWSS-63-34167	CBWSS-63-64167
125V	1P+N+G	CBSS-63-14075	CBSS-63-34075	CBSS-63-64075	CBWSS-63-14075	CBWSS-63-34075	CBWSS-63-64075
125/250V	2P+N+G	CBSS-63-14076	CBSS-63-34076	CBSS-63-64076	CBWSS-63-14076	CBWSS-63-34076	CBWSS-63-64076
208V	2P+G	CBSS-63-14162	CBSS-63-34162	CBSS-63-64162	CBWSS-63-14162	CBWSS-63-34162	CBWSS-63-64162
208V	3P+G	CBSS-63-14163	CBSS-63-34163	CBSS-63-64163	CBWSS-63-14163	CBWSS-63-34163	CBWSS-63-64163
250V	2P+G	CBSS-63-14072	CBSS-63-34072	CBSS-63-64072	CBWSS-63-14072	CBWSS-63-34072	CBWSS-63-64072
250V	3P+G	CBSS-63-14073	CBSS-63-34073	CBSS-63-64073	CBWSS-63-14073	CBWSS-63-34073	CBWSS-63-64073
277V	1P+N+G	CBSS-63-14045	CBSS-63-34045	CBSS-63-64045	CBWSS-63-14045	CBWSS-63-34045	CBWSS-63-64045
277/480V	3P+N+G	CBSS-63-14047	CBSS-63-34047	CBSS-63-64047	CBWSS-63-14047	CBWSS-63-34047	CBWSS-63-64047
480V	2P+G	CBSS-63-14042	CBSS-63-34042	CBSS-63-64042	CBWSS-63-14042	CBWSS-63-34042	CBWSS-63-64042
480V	3P+G	CBSS-63-14043	CBSS-63-34043	CBSS-63-64043	CBWSS-63-14043	CBWSS-63-34043	CBWSS-63-64043

For international configurations and ratings (IEC,CE) visit meltric.com/international-catalog or contact customer service at 800.433.7642.

Ratings

- Voltage**
20A: 480 VAC
30A: 480 VAC
60A: 480 VAC
- Environmental Ratings**
Overall: NEMA Type 4X
Box: NEMA Type 4X, 12
Receptacle: NEMA Type 4X
- Temperature Range**
Min -40°F / Max 140°F
- Listings**
Box: UL 508A
Receptacle: UL 2682,
UL 1682, CSA 22.2 No. 182.1,
IEC 60309-1

Receptacle Options	Part #
With 2 auxiliary contacts (30/60A only)	Part # - 972
With 3 auxiliary contacts (60A only)	Part # - 973*
With 4 auxiliary contacts (60A only)	Part # - 974*
Mushroom Pawl	Part # - 375
Padlock Pawl	Part # - 843
Closed lid configuration	Part # - NC

Notes: * Not UL/CSA Listed

Circuit Protection Options	Part #
'D' Trip Curve (20/30A only)	Part # - D
'B' Trip Curve (60A only)	Part # - B
Standard circuit protectors include a 'C' trip curve.	
20A: Eaton 20A, 480V 'WMZT' circuit breaker*	
30A: Eaton 30A, 480V 'WMZT' circuit breaker*	
60A: Eaton 63A, 480V 'WMZS' supplementary protector**	
* or equivalent UL 489 circuit breaker	
** or equivalent UL 1077 supplementary protector	

Main Options

-  **Auxiliary Contacts**
-  **Emergency Stop Pawl**
-  **Padlock Pawl**
-  **Closed Lid Configuration**
Lid springs to a mostly closed, prelatch position.

See pgs 211-220 for detailed information on these options





Safety Switch / Receptacle Combinations



MELTRIC's non-interlocked safety switch disconnects are intended for use in power supply applications where additional over current and short circuit protection is desired. Since Decontactor™ Series products are UL and CSA Switch-rated, there is no need for the receptacle to be interlocked to the switch. The load may be safely made or broken by throwing the switch lever or by simply connecting or disconnecting the plug.

The standard MELTRIC Safety Switch Disconnect consists of a DS Series receptacle and angle mounted and wired to a heavy duty, single throw, fusible safety switch. They can optionally be provided with DSN or DB series Decontactors, straight mounting adapters, non-fused switches, or with circuit breaker protection.

Options:

DSN Receptacle (DS is standard)

DB Receptacle

Straight Adapter (Angle is standard)

Non-Fused (Fused is standard)

Viewing Window

Reverse Service

Canadian CSA listed enclosure



Receptacle/Disconnect Combinations



Voltage	Polarity	Part #	Part #		Part #		Part #
		30A Poly	60A Poly	60A Metal	100A Poly	100A Metal	200A Metal
120V	1P+N+G	33-37165-22X	33-67166-22X	37-67165-22X	33-97166-22X	37-97165-22X	37-27165-22X
120/208V	2P+N+G	33-37166-22X	33-67166-22X	37-67166-22X	33-97166-22X	37-97166-22X	37-27166-22X
120/208V	3P+N+G	33-37167-42X	33-67167-42X	37-67167-42X	33-97167-42X	37-97167-42X	37-27167-42X
125/250V	2P+N+G	33-37076-22X	33-67076-22X	37-67076-22X	33-97076-22X	37-97076-22X	37-27076-22X
3Ø/208V	3P+G	33-37163-32X	33-67163-32X	37-67163-32X	33-97163-32X	37-97163-32X	37-27163-32X
208V	2P+G	33-37162-12X	33-67162-12X	37-67162-12X	33-97162-12X	37-97162-12X	37-27162-12X
250V	2P+G	33-37072-12X	33-67072-12X	37-67072-12X	33-97072-12X	37-97072-12X	37-27072-12X
480V	2P+G	33-37042-12X	33-67042-12X	37-67042-12X	33-97042-12X	37-97042-12X	37-27042-12X
277/480V	2P+N+G	33-37046-22X	33-67046-22X	37-67046-22X	33-97046-22X	37-97046-22X	37-27046-22X
277/480V	3P+N+G	33-37047-42X	33-67047-42X	37-67047-42X	33-97047-42X	37-97047-42X	37-27047-42X
3Ø/480V	3P+G	33-37043-32X	33-67043-32X	37-67043-32X	33-97043-32X	37-97043-32X	37-27043-32X
347/600V	2P+N+G	33-37146-22X	33-67146-22X	37-67146-22X	33-97146-22X	37-97146-22X	-
347/600V	3P+N+G	33-37147-42X	33-67147-42X	37-67147-42X	33-97147-42X	37-97147-42X	-
3Ø/600V	3P+G	33-37143-32X	33-67143-32X	37-67143-32X	33-97143-32X	37-97143-32X	-
600V	2P+G	33-37142-12X	33-67142-12X	37-67142-12X	33-97142-12X	37-97142-12X	-

- Notes:**
- When ordering a Safety Switch Disconnect, replace the "X" with the appropriate number that represents the NEMA Rating of choice.
 - For higher amperage devices, contact MELTRIC's Sales Office.

NEMA Guidelines

X (Number)	NEMA Rating
9	Type 4X
7	Type 12
5	Type 3R
1	Type 1

Ordering Information for Optional Configurations

DSN Receptacle: To order a DSN receptacle (20-60A), change prefix "33" to "63". Example: DSN 60A Poly Receptacle 250 VAC (2P+G) Type 1 = 63-67072-121

DB Receptacle: To order a DB receptacle (30-100A), change prefix "33" or "37" to "89". Example: DB 60A Metal Receptacle 250 VAC (2P+G) Type 4X = 89-67072-129

Straight Adapter: To order a straight adapter, add suffix -S to the part number. Example: DS 60A Metal Receptacle 480 VAC (3P+G) Type 1 = 37-67043-321-S

Non-Fused: To order a non fused device, add suffix -NF to the part number. Example: DS 30A Poly Receptacle 250 VAC (2P+G) Type 3R = 33-37072-125-NF

Canadian: To order a CSA listed enclosure, add suffix -CSA to the part number. CSA enclosures are provided with viewing windows as standard.

Specialty Products

WS – Welding Connectors	p. 165
Adapter Plates	p. 166
Cord Grips	p. 169
Voltage/Phase Rotation Meter	p. 171



Specialty Products

MELTRIC manufactures a wide variety of specialty products to fit specific application needs and to help users benefit from the advantages of MELTRIC's switch-rated plugs and receptacles where ever connections may need to be made and broken.

Main Advantages

- ▶ WS Single Pole Welding Connectors – Fast and reliable connections
- ▶ Backbox Adapter Plates – Simplify replacement of competitive devices with Decontactors
- ▶ Cord Grips – Enhance strain relief and cord gripping
- ▶ Voltage/Phase Rotation Meter – Easy means of testing MELTRIC receptacles for voltage

Specialty Products



WS – Welding Connectors

For fast connections of welding cables with the reliability of silver-nickel butt style contacts.

See page 165



Adapter Plates

For mounting Decontactor™ receptacles on existing back boxes that were previously used for competitive devices.

See pages 166-168



Cord Grips

For inline and other high stress applications where additional cord gripping and strain relief capabilities are beneficial.

See pages 169-170



Voltage / Phase Rotation Meter

Provides a simple means of testing receptacles to identify if voltage is available and to determine motor rotation.

See pages 171-172



WS – Welding Connectors

General Ratings

- **Voltage**
50 VAC Max
- **Amperage**
325A Continuous
500A Intermittent

WS devices allow users to make fast and reliable connections of welding cables. Their spring-loaded silver contacts provide connections that are unaffected by cable movement or vibration and operate with a self-cleaning wiping action that ensures a reliable electrical connection every time.

Notes: The chart to the right is a guideline for wiring sizes based on duty cycles.

Wiring Hole in ²	mm ²	Maximum Amperage Cycle (5 min Cycle)		
		30% Duty	60% Duty	100% Duty
.025	16	150A	100A	75A
.047	30	200A	125A	100A
.062	40	250A	150A	125A
.078	50	300A	200A	150A
.116	75	350A	250A	200A
.155	100	400A	300A	250A
.186	120	450A	350A	275A
.233	150	500A	450A	325A

Application Note

Interchangeability

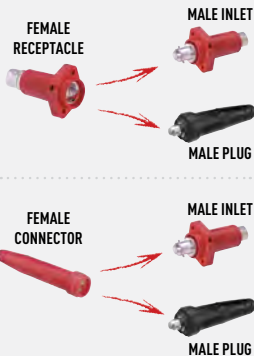

Receptacle (female) Lug Type Connection



Wiring Hole (in ²)	(mm ²)	Type 2 200A	Type 3 300A
.025	16	4-2401-A	-
.047	30	4-2401-B	-
.062	40	4-2401-C	-
.078	50	4-2401-D	4-3401-E
.116	75	-	4-3401-F
.155	100	-	4-3401-G

Inlet (male) Lug Type Connection



Wiring Hole (in ²)	(mm ²)	Type 2 200A	Type 3 300A
.025	16	4-2901-A	-
.047	30	4-2901-B	-
.062	40	4-2901-C	-
.078	50	4-2901-D	4-3901-E
.116	75	-	4-3901-F
.155	100	-	4-3901-G

Connector (female) Crimp/Solder Connection



Wiring Hole (in ²)	(mm ²)	Type 2 200A	Type 3 300A
.025	16	4-2301-A	-
.047	30	4-2301-B	-
.062	40	4-2301-C	-
.078	50	4-2301-D	4-3301-E
.116	75	-	4-3301-F
.155	100	-	4-3301-G

Plug (male) Crimp/Solder Connection



Wiring Hole (in ²)	(mm ²)	Type 2 200A	Type 3 300A
.025	16	4-0201-A	-
.047	30	4-0201-B	-
.062	40	4-0201-C	-
.078	50	4-0201-D	4-0301-E
.116	75	-	4-0301-F
.155	100	-	4-0301-G

Adapter Plates

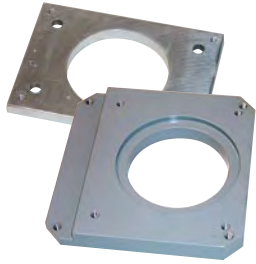

Updating your facility with MELTRIC plugs and receptacles is simple and affordable with MELTRIC's adapter plates. They allow the mounting of MELTRIC devices to existing boxes previously used for competitive devices. This avoids the cost and hassle of installing new boxes and performing associated re-piping and rewiring. If an adapter plate for the box you have is not listed, contact customer service and MELTRIC will design a new one to fit your application.

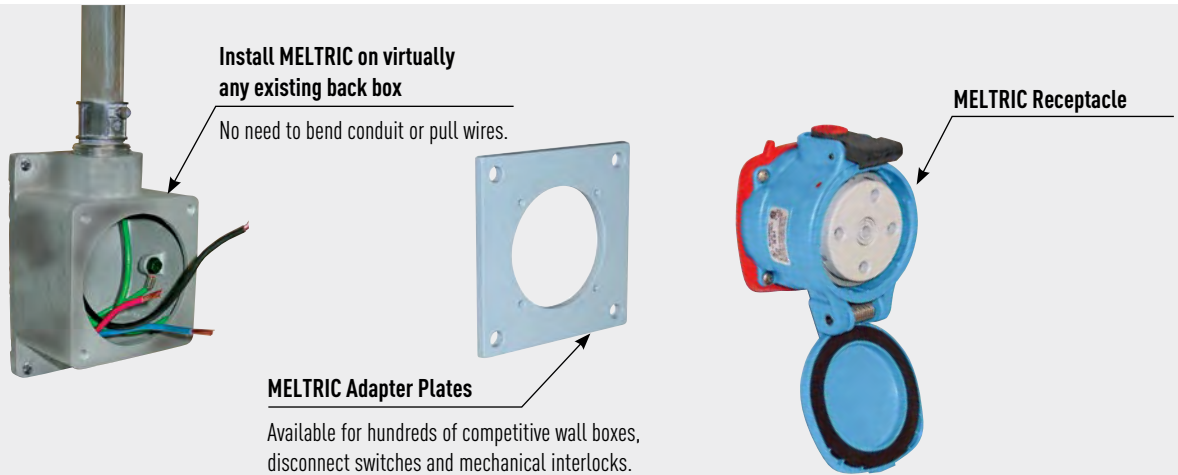

MELTRIC Part #	MELTRIC Devices	Description	Part Numbers Adapted to:		MELTRIC Part #	MELTRIC Devices	Description	Part Numbers Adapted to:	
			Appleton Crouse-Hinds		CHARE56	DS60 Recp/Inlet	<i>Appleton and Crouse-Hinds</i>	Appleton Crouse-Hinds	
CHARE36	DS30/DSN60 Recp/Inlet	<i>Appleton and Crouse-Hinds</i>	AEE36	ARE36		DS100C Recp/Inlet		AEE36	ARE36
	DS(N)37 Recp/Inlet		AEE46	ARE46				AEE46	ARE46
			AEE56	ARE56				AEE56	ARE56
			AERH36	ARRH36				AERH36	ARRH36
			AERH46	ARRH46				AERH46	ARRH46
			AERH56	ARRH56				AERH56	ARRH56
			AERC36	ARRC36				AERC36	ARRC36
			AERC46	ARRC46				AERC46	ARRC46
			AERC56	ARRC56				AERC56	ARRC56
			AERA36	ARD36				AERA36	ARD36
			AERA46	ARD46				AERA46	ARD46
			AERA56	ARD56				AERA56	ARD56
			AJA310	ARJ36				AJA310	ARJ36
			AJA410	ARJ46				AJA410	ARJ46
			AJA510	ARJ56				AJA510	ARJ56
			AJA610	ARJG36				AJA610	ARJG36
			AJ100	ARJG46				AJ100	ARJG46
				ARJG56					ARJG56
				AR60					AR60
				AR610					AR610
				AJ37					AJ37
				AJ47					AJ47
				AJ57					AJ57
				AJ67					AJ67

ADAPTER PLATES



Adapter Plates

MELTRIC Part #	MELTRIC Devices	Description	Part Numbers Adapted to:	
CHARE56	DS60 Recp/Inlet	<i>Appleton and Crouse-Hinds</i>	Appleton Crouse-Hinds	
	DS100C Recp/Inlet		AJ67	AJA6
AJA100	DS100 Recp/Inlet	<i>Appleton and Crouse-Hinds</i>	Appleton Crouse-Hinds	
			AJA310	AR610
			AJA410	AJ37
			AJA510	AJ47
			AJA610	AJ57
			AJ100	AJ67
				AJC37
				AJC47
				AJC57
				AJC67
	AJA6			
CHARE23	DS20/DSN30 Recp/Inlet	<i>Appleton Crouse-Hinds</i>	Appleton Crouse-Hinds	
			DS(IN)24 Recp/Inlet	AEE13
			AEE23	ARE23
			AEE33	ARE33
			AERH13	ARRC13
			AERH23	ARRC23
			AERH33	ARRC33
			AERC13	ARRH13
			AERC23	ARRH23
			AERC33	ARRH33
			AERA13	ARD13
			AERA23	ARD23
			AERA33	ARD33
			AR30	
			ARJ13	
			ARJ23	
			ARJ33	
	ARJG13			
	ARJG23			
	ARJG33			
CHARE33	DS30/DSN60 Recp/Inlet	<i>Appleton and Crouse-Hinds</i>	Appleton Crouse-Hinds	
			DS(IN)37 Recp/Inlet	AEE13
			AEE23	ARE23
			AEE33	ARE33
			AERH13	ARRC13
			AERH23	ARRC23
			AERH33	ARRC33
			AERC13	ARRH13
			AERC23	ARRH23
			AERC33	ARRH33
			AERA13	ARD13
			AERA23	ARD23
			AERA33	ARD33
			AR30	
			ARJ13	
			ARJ23	
			ARJ33	
	ARJG13			
	ARJG23			
	ARJG33			

MELTRIC Part #	MELTRIC Devices	Description	Part Numbers Adapted to:	
CHAJ56-MA6	MP6	<i>Appleton and Crouse-Hinds without angle adapter</i>	Appleton Crouse-Hinds	
	MA6		AJA310	AJ37
	MS6		AJA410	AJ47
			AJA510	AJ57
			AJA610	AJ67
CHFDADAPLT	09-20000-027-80	<i>FS/FD Single Gang Box</i>		
	MSPN			
	MP2			
	MP3			
	MA2			
	MA3			
	MS2			
	MS3			
	MA2-SS			
MA3-SS				
E462	61-10000-027	<i>FS/FD Single Gang Box</i>		
DSN6JAA6	DSN60 Recp/Inlet	<i>Russell Stoll boxes</i>	RUSSELL STOLL	
			JAA6-AB6	
			JAA6-45	
			JRAA-AB6	
			JE6	
			RUSSELL STOLL	
DSN6JAA6	DSN60 Recp/Inlet	<i>Russell Stoll boxes</i>	JAA6-AB6	
			RUSSELL STOLL	
JRF60	DS60 Recp/Inlet	<i>Russell Stoll boxes</i>	JAA6-AB6	
	DS100C Recp/Inlet		JAA6-45	
			JRAA-AB6	
			JE6	
			JAAB6	
PNFS-DSN1-SS	PN/DSN2 Recp/Inlet	<i>FS/FD Single Gang Box</i>		
PNFS-DSN3-SS	DS/DSN3 Recp/Inlet	<i>FS/FD Single Gang Box</i>		
			HUBBELL	
HH312	MA6	<i>Hubbell/60/100A Boxes</i>	26401	
	MP6		BB601W	
	MS6		BB602W	
			BB1001W	
			BB1002W	
			FW60100	
			HUBBELL	
HH312-E448	DS60 Recp/Inlet	<i>Hubbell/60/100A Boxes</i>	26401	
	DS100C Recp/Inlet		BB601W	
			BB602W	
			BB1001W	
			BB1002W	
			FW60100	
			KILLARK	
HH60K	DS60 Recp/Inlet	<i>Hubbell-Killark Hazardous Duty Box</i>	AJAE	
	DS100C Recp/Inlet		AJAC	
			AJAT	
MAFS6BA	MA6	<i>FS/FD Single Gang Box</i>		
	MP6			
	MS6			
			HUBBELL	
HHBB201W	DS1/DSN3 Recp/Inlet	<i>Hubbell /20/30A Boxes</i>	BB201W	

ADAPTER PLATES

MELTRIC Part #	MELTRIC Devices	Description	Part Numbers Adapted to:	
HHBB201W	DS1/DSN3 Recp/Inlet	<i>Hubbell /20/30A Boxes</i>	HUBBELL	
			BB301W	
			FT202W	
HBL26401	DS30/DSN60 Recp/Inlet	<i>Hubbell/60/100A Boxes</i> <i>60/100A Boxes</i>	HUBBELL	
			26401	
			BB601W	
			BB602W	
HBL26401	DS30/DSN60 Recp/Inlet	<i>Hubbell/60/100A Boxes</i> <i>60/100A Boxes</i>	JAA6-BB1002W	
			FW60100	
			26401	
HBL26401A	DS3/DSN6 Angle Adapter	<i>Hubbell/60/100A Boxes</i>	HUBBELL	
			4200	
HBL4200	DS200 Receptacle	<i>Hubbell 200A Boxes</i>	26401	
HHB26401	DS60 Adapters	<i>Hubbell/60/100A Boxes</i>	26402	
HH50	DS30/DSN60 Recp/Inlet	<i>Hubbell/lock/60A adapters</i> <i>60A adapters</i>	26404	
			26404	
PNFS	PN/DSN20 Recp/Inlet	<i>FS /FD Single Gang Box</i>	PYLE-NATIONAL	
PNFSPL	DS60 Recp/Inlet	<i>Pyle-National/60A Boxes</i>	JR-26046-A	
			DS100C Recp/Inlet	<i>60A Boxes</i>
				JR-36046-A
				JR-46046-A
				JR-56046-A
				JR-336046-C
				JR-446046-C
				JR-556046-C
				JR-26046-BB
				PYLE-NATIONAL
				JR-36046-BB
				JR-46046-BB
				JR-56046-BB
				JR-36046-BE
			JR-46046-BE	
			JR-56046-BE	
			JR-46046-CE	
			JR-56046-CE	
			JR-60-J	
			JR-64-D	
PNJRB30	09-20000-027-80	<i>Pyle-National</i> <i>20/30A Boxes</i>	PYLE-NATIONAL	
			JRW-13046-A	
			JRW-23046-A	
			JRW-33046-A	
			JRW-113046-C	
			JRW-223046-C	
			JRW-333046-C	
			JR-13046-BB	
			JR-23046-BB	
			JR-33046-BB	
			JR-43046-BB	
			JRW-13046-BE	
			JRW-23046-BE	
JRW-33046-BE				
JR-23046-CE				

MELTRIC Part #	MELTRIC Devices	Description	Part Numbers Adapted to:
PLN30	09-20000-027-80	<i>Pyle-National/60A Boxes</i>	PYLE-NATIONAL
			JR-26046-A
			JR-36046-A
			JR-46046-A
			JR-56046-A
			JR-336046-C
			JR-446046-C
			JR-556046-C
			JR-26046-BB
			JR-36046-BB
PLN60	MP6	<i>Pyle-National/60A Boxes</i>	JR-26046-A
			JR-36046-A
			JR-46046-A
AP-RAC04X4-FS	MAFS1	<i>4"x4" sheet metal boxes</i>	JR-56046-A
			JR-336046-C
			JR-446046-C
			JR-556046-C
			JR-26046-BB
			JR-36046-BB
			JR-46046-BB
			JR-56046-BB
			JR-36046-BE
			JR-46046-BE
JR-56046-BE			
JR-46046-CE			
JR-56046-CE			
JR-60-F			
JR-64-D			
AP-RAC04X4-FS	MAFS2	<i>4"x4" sheet metal boxes</i>	JR-26046-A
			JR-36046-A
			JR-46046-A
AP-RAC04X4-FS	MAFS3	<i>4"x4" sheet metal boxes</i>	JR-56046-A
			JR-336046-C
			JR-446046-C



Cord Grips

Poly Cord Grips



w/Metal Mesh



Aluminum Cord Grips



w/Aluminum Mesh



Handle NPT C	Cable Range B	Part # Cord Grip	Part # Cord Grip w/Mesh
1/2"	.312-.375	CG121P	CG121PM
1/2"	.375-.438	CG122P	CG122PM
1/2"	.438-.500	CG123P	CG123PM
1/2"	.500-.562	CG124P	CG124PM
1/2"	.562-.625	CG125P	CG125PM
3/4"	.438-.500	CG340P	CG340PM
3/4"	.500-.562	CG341P	CG341PM
3/4"	.562-.625	CG342P	CG342PM
3/4"	.625-.750	CG344P	CG344PM
3/4"	.688-.812	CG345P	CG345PM
1"	.660-.780	CG1001P	-
1"	.770-.895	CG1002P	-
1"	.870-1.020	CG1003P	-
1"	.890-1.090	CG1004P	-
1 1/4"	.890-1.090	CG1141P	-
* 1 1/4"	1.080-1.280	CG1142P	-
1 1/4"	1.270-1.470	CG1143P	-
1 1/4"	-	-	-
1 1/2"	.890-1.150	CG1121P	-
1 1/2"	1.140-1.400	CG1122P	-
1 1/2"	-	-	-
1 1/2"	-	-	-

Cable Range B	Part # Cord Grip	Part # Cord Grip w/Mesh
.312-.375	CG121A	CG121AM
.375-.438	CG122A	CG122AM
.438-.500	CG123A	CG123AM
.500-.562	CG124A	CG124AM
.562-.625	CG125A	CG125AM
.438-.500	CG340A	CG340AM
.500-.562	CG341A	CG341AM
.562-.625	CG342A	CG342AM
.625-.750	CG344A	CG344AM
.688-.812	CG345A	CG345AM
.750-.875	CG1001A	CG1001AM
.812-.938	CG1002A	CG1002AM
.875-1.000	CG1003A	-
-	-	-
.875-1.000	CG1141A	CG1141AM
1.000-1.125	CG1142A	CG1142AM
* 1.125-1.250	CG1143A	CG1143AM
* 1.250-1.375	CG1144A	CG1144AM
1.250-1.375	CG1121A	CG1121AM
1.438-1.562	CG1122A	CG1122AM
* 1.562-1.688	CG1123A	CG1123AM
* 1.688-1.812	CG1124A	CG1124AM

Notes: * Cable may have to be stripped to pass through the bore of the cord grip body (A).



Cord Grip

Poly Cord Grips



w/Metal Mesh



Aluminum Cord Grips



w/Aluminum Mesh



Handle NPT C	Cable Range B	Part # Cord Grip	Part # Cord Grip w/Mesh
2"	1.190 - 1.530	CG2001P	-
2"	1.520 - 1.860	CG2002P	-
2"	1.850 - 2.190	CG2003P	-
2"	-	-	-
2"	-	-	-
2"	-	-	-
2 1/2"	-	-	-
2 1/2"	-	-	-
2 1/2"	-	-	-
3"	-	-	-
3"	-	-	-

Cable Range B	Part # Cord Grip	Part # Cord Grip w/Mesh
1.688 - 1.812	CG2001A	CG2001AM
1.812 - 1.938	CG2002A	CG2002AM
* 1.938 - 2.062	CG2003A	CG2003AM
* 2.062 - 2.188	CG2004A	CG2004AM
* 2.188 - 2.312	CG2005A	CG2005AM
* 2.312 - 2.438	CG2006A	CG2006AM
2.062 - 2.188	CG2121A	CG2121AM
2.188 - 2.312	CG2122A	CG2122AM
* 2.312 - 2.438	CG2123A	CG2123AM
2.437 - 2.625	CG3001A	CG3001AM
2.625 - 2.812	CG3002A	CG3002AM

Cable Size Reference Table

Cable Type / Size	Nominal Cable Dia.	Cable Type / Size	Nominal Cable Dia.	Cable Type / Size	Nominal Cable Dia.
16/2 SOW	0.37	8/5 SO	0.92	14/40 SOW	1.55
16/3 SOW	0.39	3/8 W	0.91	3/0 - 2 W	1.67
16/5 SOW	0.51	8/4 W	0.97	3/0 - 3 W	1.77
14/4 SOW	0.58	6/4 W	1.07	2/0 - 4 W	1.81
12/3 SOW	0.62	6/5 W	1.21	1/5 W	1.84
12/4 SOW	0.67	4/4 W	1.27	1/0 - 5 W	1.96
12/5 SOW	0.73	20/12 SOW	1.29	2/0 - 5 W	2.09
10/3 SOW	0.67	14/24 SOW	1.32	4/0 - 4 W	2.10
10/5 SOW	0.80	4/5 W	1.34	3/0 - 5 W	2.24
10/6 SOW	0.88	3/5 W	1.42	4/0 - 5 W	2.40
14/12 SOW	0.91	2/5 W	1.55		

PHASE ROTATION METER



Voltage / Phase Rotation Meter Assemblies

Voltage/Phase Rotation Meters offer customers an easy means of testing MELTRIC receptacles for voltage, as well as, motor rotation. The product consists of an inlet and handle wired to the meter. Smaller devices use standard nylon handles, while larger devices are provided with PH handles and cord-grips.



Order Example

The plug with voltage rotation meter assembly should be ordered to match the receptacles to be tested.



Existing 63-64043 receptacle



Matching plug with voltage phase rotation meter assembly 63-61043-MTR

Switch-Rated Inlet and Voltage/Phase Rotation Meter Assemblies DSN Series

Voltage	Polarity	Part # 20A	Part # 30A	Part # 60A
120V	1P+N+G	63-11165-MTR	63-31165-MTR	63-61165-MTR
120/208V	3P+N+G	63-11167-MTR	63-31167-MTR	63-61167-MTR
125V	1P+N+G	63-11075-MTR	63-31075-MTR	63-61075-MTR
125/250V	2P+N+G	63-11076-MTR	63-31076-MTR	63-61076-MTR
208V	2P+G	63-11162-MTR	63-31162-MTR	63-61162-MTR
208V	3P+G	63-11163-MTR	63-31163-MTR	63-61163-MTR
250V	2P+G	63-11072-MTR	63-31072-MTR	63-61072-MTR
250V	3P+G	63-11073-MTR	63-31073-MTR	63-61073-MTR
277V	1P+N+G	63-11045-MTR	63-31045-MTR	63-61045-MTR
277/480V	3P+N+G	63-11047-MTR	63-31047-MTR	63-61047-MTR
347/600V	3P+N+G	-	63-31147-MTR	63-61147-MTR
480V	2P+G	63-11042-MTR	63-31042-MTR	63-61042-MTR
480V	3P+G	63-11043-MTR	63-31043-MTR	63-61043-MTR
600V	2P+G	-	63-31142-MTR	63-61142-MTR
600V	3P+G	-	63-31143-MTR	63-61143-MTR

DS Series

Voltage	Polarity	Part # 20A	Part # 30A	Part # 60A	Part # 100A	Part # 100A	Part # 200A
120V	1P+N+G	33-11165-MTR	33-31165-MTR	33-61165-MTR	33-61165-C-K16-MTR	33-91165-MTR	37-21165-MTR
120/208V	3P+N+G	33-11167-MTR	33-31167-MTR	33-61167-MTR	33-61237-C-K16-MTR	33-91167-MTR	37-21167-MTR
125V	1P+N+G	33-11075-MTR	33-31075-MTR	33-61075-MTR	33-61175-C-K07-MTR	33-91075-MTR	37-21075-MTR
125/250V	2P+N+G	33-11076-MTR	33-31076-MTR	33-61076-MTR	33-61176-C-K07-MTR	33-91076-MTR	37-21076-MTR
208V	2P+G	33-11162-MTR	33-31162-MTR	33-61162-MTR	33-61232-C-K16-MTR	33-91162-MTR	37-21162-MTR
208V	3P+G	33-11163-MTR	33-31163-MTR	33-61163-MTR	33-61233-C-K16-MTR	33-91163-MTR	37-21163-MTR
250V	2P+G	33-11072-MTR	33-31072-MTR	33-61072-MTR	33-61172-C-K07-MTR	33-91072-MTR	37-21072-MTR
250V	3P+G	33-11073-MTR	33-31073-MTR	33-61073-MTR	33-61173-C-K07-MTR	33-91073-MTR	37-21073-MTR
277V	1P+N+G	33-11045-MTR	33-31045-MTR	33-61045-MTR	33-61245-C-K04-MTR	33-91045-MTR	37-21045-MTR
277/480V	3P+N+G	33-11047-MTR	33-31047-MTR	33-61047-MTR	33-61247-C-K04-MTR	33-91047-MTR	37-21047-MTR
347/600V	3P+N+G	33-11147-MTR	33-31147-MTR	33-61147-MTR	33-61187-C-K14-MTR	33-91147-MTR	37-21147-MTR
480V	2P+G	33-11042-MTR	33-31042-MTR	33-61042-MTR	33-61242-C-K04-MTR	33-91042-MTR	37-21042-MTR
480V	3P+G	33-11043-MTR	33-31043-MTR	33-61043-MTR	33-61243-C-K04-MTR	33-91043-MTR	37-21043-MTR
600V	2P+G	33-11142-MTR	33-31142-MTR	33-61142-MTR	33-61182-C-K14-MTR	33-91142-MTR	37-21142-MTR
600V	3P+G	33-11143-MTR	33-31143-MTR	33-61143-MTR	33-61183-C-K14-MTR	33-91143-MTR	37-21143-MTR

DB Series

Voltage	Polarity	Part # 30A	Part # 60A	Part # 100A
120V	1P+N+G	89-31165-MTR	89-61165-MTR	89-91165-MTR
120/208V	3P+N+G	89-31167-MTR	89-61167-MTR	89-91167-MTR
125V	1P+N+G	89-31075-MTR	89-61075-MTR	89-91075-MTR
125/250V	2P+N+G	89-31076-MTR	89-61076-MTR	89-91076-MTR
208V	2P+G	89-31162-MTR	89-61162-MTR	89-91162-MTR
208V	3P+G	89-31163-MTR	89-61163-MTR	89-91163-MTR
250V	2P+G	89-31072-MTR	89-61072-MTR	89-91072-MTR
250V	3P+G	89-31073-MTR	89-61073-MTR	89-91073-MTR
277V	1P+N+G	89-31045-MTR	89-61045-MTR	89-91045-MTR
277/480V	3P+N+G	89-31047-MTR	89-61047-MTR	89-91047-MTR
347/600V	3P+N+G	89-31147-MTR	89-61147-MTR	89-91147-MTR
480V	2P+G	89-31042-MTR	89-61042-MTR	89-91042-MTR
480V	3P+G	89-31043-MTR	89-61043-MTR	89-91043-MTR
600V	2P+G	89-31142-MTR	89-61142-MTR	89-91142-MTR
600V	3P+G	89-31143-MTR	89-61143-MTR	89-91143-MTR

Notes: • Only the voltage indication function will work for single phase devices. The rotation of the motor cannot be determined because only one phase is in use.

Hazardous Location Plugs & Receptacles

The MELTRIC Advantage

MELTRIC offers a range of hazardous duty rated devices for use in power supply and control applications. Each device features MELTRIC's butt-style contact technology that maximizes durability and performance. Depending on application needs, most devices can be configured for use in in-line and wall mounted applications.

Common industry applications:

- ▶ Chemical plants
- ▶ Pharmaceutical plants
- ▶ Oil and Gas facilities
- ▶ Grain silos
- ▶ Wood processing plants
- ▶ Plastics plants
- ▶ Wastewater plants



"Flush Mounted" DX Series
plug and receptacle



"Inline" DXN Series plug
and connector

Explanation of Area Classifications and Relevant Listings

DXN Series plugs and receptacles are CSA Class I, Division 2 and Class II, Division 2 rated and CSA Class I Zone 1 and Class II Zone 21 rated (US and Canada). Alternatively, MELTRIC plugs and receptacles are ATEX rated for use in zone 1/21 and zone 2/22 classified areas (International). The reference table below shows the North American rating system and the corresponding IEC system.

Gas

Explosive atmosphere	Continuously present	May occur in normal conditions	May appear accidentally or in abnormal conditions
North American	Class I, Division 1		Class I, Division 2
IEC / Europe	Zone 0	Zone 1	Zone 2

Dust

Explosive atmosphere	Continuously present	May occur in normal conditions	May appear accidentally or in abnormal conditions
North American	Class II, Division 1		Class II, Division 2
IEC / Europe	Zone 20	Zone 21	Zone 22

- DXN Series devices carry ratings highlighted in yellow AND gray.
- DX, DXN25c, DXN37c, PXN12c, SPeX devices carry ratings highlighted in yellow ONLY.

Selecting the Right Hazardous Location Rated Plug & Receptacle

Product Line Summary

DXN plugs and receptacles are ideal for power connections where compact, lightweight devices are preferred. DXN's are CSA or ATEX rated and can be configured for inline or wall mounted applications.

DXA1 plugs and receptacles are excellent for use where rugged metal construction is required on inline or wall mounted applications.

DS60/DSN150 plugs and receptacles are excellent for Division 2 / Zone 2 environments where rugged metal construction is required and when there is a need for amperages of 60A to 150A or hp rating to 75 hp.

DX plugs and receptacles are excellent for use where rugged metal construction is required and when there is a need for amperages up to 100A. DX's are ATEX rated.

PXN12C multipin plugs and receptacles are ideal for applications requiring compact size. Twelve contacts are available with ATEX ratings up to 10A and 220V.

DXN25C and DXN37C multipin plugs and receptacles are excellent for low amperage control applications. Twenty-five and thirty-seven contacts are available on the devices which are ATEX rated up to 10A and 440V (DXN25C) or 10A and 220V (DXN37C).

SPeX single pole plugs and connectors are suitable for high amperage applications up to 680A and 1000V where safety and ease of operation are preferred. SPeX's are ATEX rated.



Hazardous Duty Product Specifications

Product Type	Housing Material	Voltage (Max)	Number of Contacts	Amperage		Wiring Capacity		Environmental Rating	Wiring Connection	Catalog Page
				Current Interrupting	Non-Current Interrupting	Min	Max			
DXN20	Polyester	480	3P+N+G	20	-	16 AWG	10 AWG	IP66/IP67	Screw	179
DXN30	Polyester	600	3P+N+G	30	-	14 AWG	6 AWG	IP66/IP67	Screw	181
DXN60	Polyester	600	3P+N+G	60	-	10 AWG	4 AWG	IP66/IP67	Screw	183
DXA1	Metal	550	3P+N+G	20	-	16 AWG	10 AWG	IP66/IP67	Screw	188
DS60	Metal	600	3P+N+G	-	60	10 AWG	2 AWG	Type 4X	Screw	191
DSN150	Metal	600	3P+N+G	-	150	10 AWG	2/0 AWG	Type 4X	Screw	193
DX20	Aluminum	600	3P+N+G	20	-	14 AWG	6 AWG	IP65	Screw	199
DX30	Aluminum	600	3P+N+G	30	-	14 AWG	6 AWG	IP65	Screw	200
DX60	Aluminum	600	3P+N+G	60	-	8 AWG	2 AWG	IP65	Screw	201
DX100	Aluminum	600	3P+N+G	100	-	4 AWG	2 AWG	IP65	Screw	202
PXN12c	Metal	220	11P+G	-	10	16 AWG	14 AWG	IP65/IP66	Solder/Crimp	206
DXN25c	Metal	440	24P+G	-	10	16 AWG	14 AWG	IP66/IP67	Solder/Crimp	208
DXN37c	Metal	220	36P+G	-	10	16 AWG	14 AWG	IP66/IP67	Solder/Crimp	208
SPeX	Polyester	1000	1	-	680	2/0 AWG	750 MCM	IP66	Lug	210

DXN



Features and Ratings	p. 176
Certifications and Testing	p. 177
Operation	p. 178
DXN20	p. 179
DXN30	p. 181
DXN60	p. 183
Dimensions	p. 185



Hazardous location rated plugs and receptacles



Watch the DXN video and other product videos at meltric.com/video

DXN Series plugs and receptacles are convenient, lightweight devices that are safe for use in hazardous environments such as refineries or silos where exposure to flammable gas or dust is a concern. The DXN's compact size and durable construction makes them easy to handle and well suited for in-line connections of electrical equipment. The DXN's dead front construction assures electrical safety by preventing user access to live parts. IP66/IP67 ratings are achieved as soon as the plug and receptacle are mated, making them the perfect choice for wet or dusty environments.

Main Advantages

- ▶ Easy to handle due to compact, lightweight design
- ▶ Available in in-line and wall/panel mounted configurations
- ▶ CSA, ATEX and IECEx rated for use in Zones 1 and 2 (gas) and Zones 21 and 22 (dust).

Product Features



Pushbutton Pawl / OFF Button

Provides quick, safe and easy current interruption.

Silver-Nickel Contacts

Silver-nickel contact material provides superior conductivity, durability and corrosion resistance.

Hazardous Location Termination Areas

Includes enhanced creepage and clearance distances and specially designed terminals to ensure perfect and permanent clamping.

Casing

Self-extinguishing, non-static, material provides outstanding resistance to mechanical abuse and chemicals.

Lid

When closed, the lid maintains IP66/IP67 protection for the receptacle after removal of the plug.

Spring-Loaded Butt-Style Contacts

Ensures optimal contact force and superior electrical performance over thousands of operations.

Explosion Proof Arc Chamber

Withstands internal pressure due to gas/dust ignited by arcing and isolates it from the outside environment.

Explosion Proof Flame Path

Dissipates internal pressure created during arcing while also preventing any associated ignition sources from reaching the surrounding atmosphere.

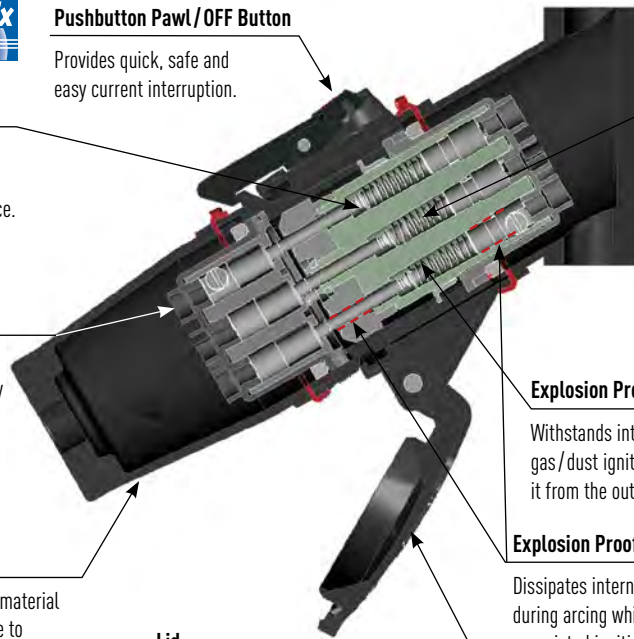

Operating Instructions



To connect, align the red dots, push the plug partially in, then turn clockwise slightly to line up the latch with the catch.



Push the plug fully home until it is held in place by the latch. The circuit is now closed.



To disconnect, depress the latch and pull the plug simultaneously. This breaks the circuit. The plug contacts are now dead.

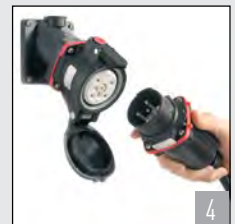

Rotate 30° counterclockwise and then withdraw the plug. The safety shutter prevents access to live parts.

General Ratings

Amperage	20 to 60A
Voltage	600 VAC*
Frequency	50-400 Hz
Horsepower	1/2 to 20 hp
Environmental	IP66/IP67
Temperature	min -40°F/max 140°F

* DXN30 and DXN60 devices are 550VAC if ordered with optional auxiliary contacts.

Hazardous Location Listings (CSA or ATEX)

CSA	OF	ATEX
Ex de IIC T*Gb		II 2 G/D
Ex tb IIIC T*Db		Ex de IIC T*Gb Ex tb IIIC T*Db
Class I Zone I AEx de IIC T*Gb		
Zone 21 AEx tD T*Db		
Class I Division 2 Gr A,B,C,D		
Class II Division 2 Gr E,F,G		

* See temperature tables in product sections.
See following page for additional ratings detail.

Plug & Receptacle Listings (CSA or ATEX)

Category	CSA	IEC
Plugs and Receptacles	C22.2 No. 182.1	60309-1

CE ratings available upon request

Highlighted Feature

Dead Front



The dead front on the DXN receptacle provides protection from accidental tool and wire insertion.

HAZARDOUS LOCATION

DXN Certifications

Hazardous Duty Certification (example)

DXN's have CSA and ATEX certifications for use in hazardous locations.

CSA

-40°C ≤ Ta ≤ +60°C

Class I Zone 1 AEx de IIC T5, Gb

Zone 21, AEx tD T90°C Db

Class I Division 2 Gr A,B,C,D

Class I – Indicates suitability for use in applications where flammable Gases, Vapors, or Mists may be present.

Zone I – Indicates suitability for use in applications where an explosive environment is likely to occur in the air in sufficient quantities to produce explosive or ignitable mixtures under normal operating conditions.

Division 2 – Indicates suitability for use where exposure to the hazard occurs under abnormal conditions.

GR A,B,C,D – Indicates suitability for use in areas that may contain Acetylene, Hydrogen, Ethylene, or Propane.

Class II Division 2 Gr E,F,G

Class II – Indicates suitability for use in applications where explosive dust atmosphere may occur.

Division 2 – Indicates suitability for use where hazard exposure occurs under abnormal conditions.

GR E,F,G – Indicates suitability for use in areas where Magnesium, Coal or Grain dust may occur.



CSA certification based on IEC 60079-0, 60079-1, 60079-7

ATEX and IECEx

II 2 G/D Ex de IIC T* Gb

Ex tb IIIC T* Db

-40°C ≤ Ta ≤ +60°C T5 T90°C

-40°C ≤ Ta ≤ +40°C T6 T70°C



II – Indicates suitability for installation in surface applications (as opposed to underground mine applications).

2 – Indicates suitability for use where a high level of protection is required and where the presence of an explosive atmosphere is likely to occur occasionally during normal operation (Zone 1 and Zone 21 environments).

G/D – Indicates suitability for installation in areas that may contain flammable gases, vapors/mists, or dusts.

T90°C* – Indicates a maximum surface temperature of the product of 90°C, at -40°C to 60°C ambient.

Ex de – Indicates that explosion protection is provided with (e) increased safety in the conductor termination area, and (d) flame proof chambers for making and breaking the current that can withstand the pressure of internal ignition and that prevent arcs, flame or other ignition events from being communicated to the surrounding atmosphere.

IIC – Indicates suitability for installation in areas where exposure to any type of gas, including the most dangerous subdivision C gases may occur.

T6* – Temperature class – the maximum product surface temperature is 185°F (85°C) for ambient temperature of 104°F (40°).

ATEX certification was performed by LCIE.

* Temperature ratings vary depending on product and ambient temperature. See specific product section for temperature ratings.

Electrical Performance Testing

Key Performance Tests Passed					
Model	Mechanical Endurance	Electrical Endurance ¹	Overload Testing ²	Temperature Rise (max)	Dielectric Test
DXN20	-	5000 Operations	50 Operations	30°C	2 x V (rated) + 1000V
DXN30	1000 Cycles	1000 Operations	50 Operations	30°C	2 x V (rated) + 1000V
DXN60	1000 Cycles	1000 Operations	50 Operations	30°C	2 x V (rated) + 1000V

DXN Operation

Arcing is a natural occurrence when electrical contacts make and break under load. The purpose of a hazardous duty product is to prevent arcing from igniting hazardous gases or dusts present in the atmosphere into an explosion that may cause personal injury or damage to facilities and equipment. The DXN accomplishes this with specially designed flame-proof arc chambers.

The arc chambers are sized to minimize the amount of atmospheric gas or air/dust mixture that may ignite during arcing and are built to contain this internal mini-explosion and withstand the pressure that it generates. The length and width of the flame-proof pathways are very precisely designed to provide for the effective dissipation of the pressure, while also ensuring that the arcing and internal ignitions of gases or air/dust mixture in the arc chamber are totally isolated from the surrounding atmosphere.

- 1 When the plug and receptacle are connected, the flameproof arc chamber is completed with pressure relief/arc extinguishing pathways between the outer diameter of the plug contact and its associated contact hole in the safety shutter and between the main interior component and receptacle contact base.
- 2 DXN's are current interrupting rated devices. They can safely make and break under full load and also during moderate overload situations. During the making or breaking of the contacts, the arc chamber completely contains any ignitions of gas or dust due to arcing and the flame-proof pathways dissipate the pressure.
- 3 As the plug is being inserted or removed, the flame-proof arc chamber and pathways are maintained. This ensures continuous hazardous duty protection and the safety of the user.
- 4 When the plug and receptacle are disconnected, the receptacle maintains a flame-proof chamber. In this case, the flame-proof pathway exists between the safety shutter and the main interior component. The shutter also prevents access to live parts, providing users with the safety of a dead front. The plug must be inserted into the safety shutter and be rotated in order to access the receptacle contacts.

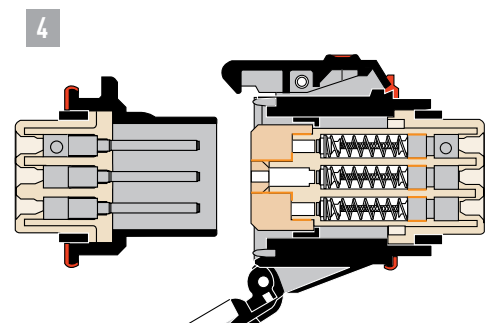
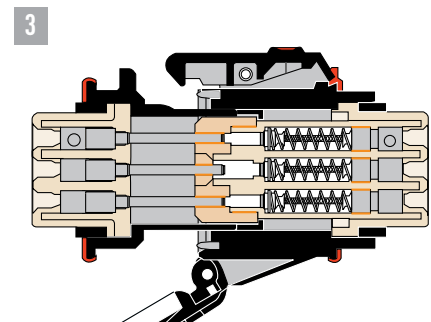
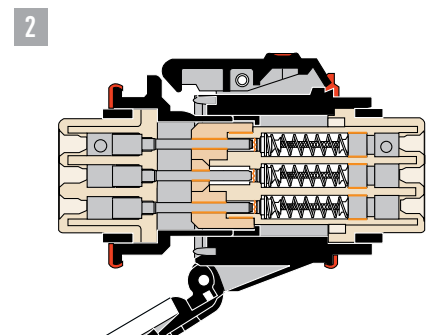
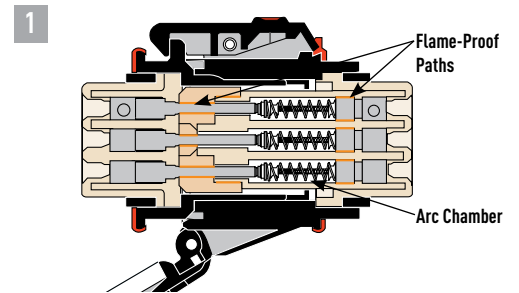

**DXN20
DXN1**



DXN – 20A Hazardous Location Plugs & Receptacles

Devices rated for hazardous locations are not returnable.

UL Ratings DXN20/DXN1

- **Max Amperage & Voltage**
20A, 600 VAC, 60 Hz
- **Current Interruption Capability**
For current interrupting (AC)
- **Horsepower Ratings**
 - 120V 1Ø 1/2 hp
 - 240V 3Ø 2 hp
 - 480V 3Ø 5 hp
 - 600V 3Ø 5 hp
- **Wiring Capacity**
Min 16 AWG Max 10 AWG
* Based on THHN wire sizes
- **Applicable Standards**
CSA C22.2 No. 182.1
- **Hazardous Location Ratings**

-40°C ≤ T_a ≤ +60°C
Ex de IIC T5 Gb Ex tb IIIC T90°C Db
Class I Zone1 AEx de IIC T5 Gb
Zone 21 AEx tD T90°C Db
Class I Div 2 Gr A,B,C,D
Class II Div 2 Gr E,F,G
cCSAus 00.1144106X

Receptacle



Receptacles & Inlets must be mounted to a DXN handle, angle or wall box.



Standard DXN20 lid opens to 120°

Inlet



North American Configurations (cCSAus)

Voltage	Polarity	Part # Poly	Voltage	Polarity	Part # Poly
120V	1P+N+G	22-14165	120V	1P+N+G	22-18165
125V	1P+N+G	22-14075	125V	1P+N+G	22-18075
208V	2P+G	22-14162	208V	2P+G	22-18162
208V	3P+G	22-14163	208V	3P+G	22-18163
208V	3P+N+G	22-14167	208V	3P+N+G	22-18167
250V	2P+G	22-14072	250V	2P+G	22-18072
250V	3P+G	22-14073	250V	3P+G	22-18073
250V	2P+N+G	22-14076	250V	2P+N+G	22-18076
277V	1P+N+G	22-14045	277V	1P+N+G	22-18045
480V	2P+G	22-14042	480V	2P+G	22-18042
480V	3P+G	22-14043	480V	3P+G	22-18043
480V	3P+N+G	22-14047	480V	3P+N+G	22-18047
600V	2P+G	22-14142	600V	2P+G	22-18142
600V	3P+G	22-14143	600V	3P+G	22-18143
600V	3P+N+G	22-14147	600V	3P+N+G	22-18147

Receptacle Options	Part #
Padlock Pawl	Recept # - 843
Metal Pawl on Poly Receptacle	Recept # - 924
Closed Lid Configuration	Recept # - R
180° Lid Opening	Recept # - 180

Inlet Options	Part #
No Lockout Hole	Inlet # - A155

IEC/CE Ratings DXN1

- **Current** 20A, 50 Hz
- **Environmental** IP66/IP67
- **Ambient Temp** -40°C to +60°C
- **Hazardous Location Ratings**
ATEX/IECEx Zones 1 & 2, 21 & 22

MARECHAL ELECTRIC MAROMME

Ex de IIC T*Gb
Ex tb IIIC T*Db

-40°C ≤ T_a ≤ +60°C T5 T90°C

-40°C ≤ T_a ≤ +40°C T6 T70°C

IECEx LCI 09.0005X / LCIIE 99 ATEX 6027X

See MELTRIC's International Catalog (online) for additional product information.

Receptacle

IEC/CE Configurations (ATEX/IECEx)

Voltage	Polarity	Part #	Voltage	Polarity	Part #
20 - 24 V	2P	25-1408A	20 - 24 V	2P	25-1808A
190 - 230 V	3P+E	25-14033	190 - 230 V	3P+E	25-18033
220 - 250 V	1P+N+E	25-14015	220 - 250 V	1P+N+E	25-18015
380 - 440 V	3P+E	25-14013	380 - 440 V	3P+E	25-18013
380 - 440 V	3P+N+E	25-14017	380 - 440 V	3P+N+E	25-18017
480 - 500 V	3P+E	25-14093	480 - 500 V	3P+E	25-18093
480 - 500 V	3P+N+E	25-14097	480 - 500 V	3P+N+E	25-18097

Receptacle Options	Part #	Receptacle Options	Part #
Padlock Pawl w/shaft for 3 locks	Recept # + 844	Self-returning Lid	Recept # + R
180° Opening Lid	Recept # + 10	180° Opening & Self-returning Lid	Recept # + 18

Installation Accessories

Accessories rated for hazardous locations are not returnable.

Handles



For Zone 1/21 applications



For use with Class I/II Division 2 or Zone 1/21 fittings

Cable Range	Poly Handle w/Bushing ⁺	NPT	Poly Handle w/NPT***
.31 - .51	22-1A013-20P ⁺	1/2"	22-1A013-12***
.51 - .75	22-1A013-25P ⁺	3/4"	22-1A013-34***
.67 - .98	22-1A013-32P ⁺		

Angles



Nylon 30° Angle

22-1A057

⁺ ATEX rated for use in Zone 1/21, not listed for Class I or II, Division 2.
^{***} For use in Class I or II, Division 2 or Zone 1/21 depending on fitting used. Fitting manufactured by others.

Wall Boxes



82.3 in³⁺



4.5 in³⁺



4.5 in³⁺



75.0 in³⁺

Cable Range	Poly 70° ⁺⁺ Wall Box	NPT	Poly 30°* Wall Box	Poly 30°** Wall Box	Poly 70°*** Alum Wall Box
.393 - .551	22-1AB58	1/2"	22-1A023-12-T	22-1A023-12-B	22-1A058-12
		3/4"	22-1A023-34-T	22-1A023-34-B	22-1A058-34
		1"	-	-	22-1A058-1
		1 1/4"	-	-	22-1A058-114
		1 1/2"	-	-	22-1A058-112

Will be discontinued in 2017 - contact customer service for availability.

⁺ Interior volume with receptacle installed. * NPT thread on top.
⁺⁺ Poly cord grip is located on the top of box. ** NPT thread on bottom.
 For bottom cord entry, rotate the box 180°. *** NPT is drilled on top of aluminum box as standard. For NPT on side only, add an "L" suffix. To switch from top to bottom or left to right the box can be rotated 180°.

Miscellaneous Accessories



* Set of Two (2)



For Male Devices Only



Finger Drawplates	Protective Cap	Receptacle ⁺ Lockout Pin
61-1A346	22-1A426	LP-843

* Recommended for cord to cord assembly applications, for easier connector closure.
⁺ Requires Padlockable Pawl option (-843) on receptacle.

Angles

(ATEX/IECEX)



* For panel mounting. Not a replacement part for 70° wall box.

Inclined Poly 30°	Inclined Poly 70°
25-1A057	25-1A757

Boxes

(ATEX/IECEX)



Ex cable gland	Wall Box Poly 30°	Wall Box Poly 30°	Wall Box Poly 30°
M20	25-1AB53	7-14 mm 25-1AB88-20P	120x120 w/o terminal blocks* 25-1A088-20P
M25	25-1AB53-25P	10-18 mm 25-1AB88-25P	120x120 w/4mm ² terminal blocks** 25-1A088-25P
M32	-	17-24 mm 25-1AB88-32P	-

COMING SOON

Contact Customer Service

Handles

(ATEX/IECEX)



with Earth continuity

Ex cable gland	Straight Poly with Poly Cable Gland	Straight Poly with Metal Cable Gland
M20	25-1A753	7-14 mm 25-1A53-20M 8-10 mm
M25	25-1A253-25P	10-18 mm 25-1A253-25M 12-14 mm
M32	25-1A253-32P	17-24 mm 25-1A253-32M 18-24 mm

* With earth continuity + 1 hole with a poly cable gland.
^{**} With 2 holes (1 with a cable gland + 1 with a stopping plug), with 8+2E 4 mm² terminals blocks + 2.5 mm² wires, wiring 2.5-4 mm². For loop in loop out wiring.

DXN30 DXN3



DXN – 30A Hazardous Location Plugs & Receptacles

Devices rated for hazardous locations are not returnable.

SP US Ratings DXN30/DXN3

- Max Amperage & Voltage**
30A, 600 VAC, 60 Hz
- Current Interruption Capability**
For current interrupting (AC)
- Horsepower Ratings**
 - 120V 1Ø 1 hp
 - 240V 3Ø 5 hp
 - 480V 3Ø 10 hp
 - 600V 3Ø 15 hp
- Wiring Capacity**
Min 14 AWG Max 6 AWG
Aux Contacts - Max 10 AWG
* Based on THHN wire sizes
- Applicable Standards**
CSA C22.2 No. 182.1
- Hazardous Location Ratings**

-40°C ≤ Ta ≤ +60°C
Ex de IIC T5 Gb Ex tb IIIC T77°C Db
Class I Zone1 AEx de IIC T5 Gb
Zone 21 AEx tD T77°C Db
Class I Div 2 Gr A,B,C,D
Class II Div 2 Gr E,F,G
cCSAus 00.1144106X

Receptacle

Inlet



Receptacles & Inlets must be mounted to a DXN handle, angle or wall box.



Standard DXN20 lid opens to 120°



North American Configurations (cCSAus)

Voltage	Polarity	Part # Poly	Voltage	Polarity	Part # Poly
120V	1P+N+G	22-34165	120V	1P+N+G	22-38165
125V	1P+N+G	22-34075	125V	1P+N+G	22-38075
208V	2P+G	22-34162	208V	2P+G	22-38162
208V	3P+G	22-34163	208V	3P+G	22-38163
208V	3P+N+G	22-34167	208V	3P+N+G	22-38167
250V	2P+G	22-34072	250V	2P+G	22-38072
250V	3P+G	22-34073	250V	3P+G	22-38073
250V	2P+N+G	22-34076	250V	2P+N+G	22-38076
277V	1P+N+G	22-34045	277V	1P+N+G	22-38045
480V	2P+G	22-34042	480V	2P+G	22-38042
480V	3P+G	22-34043	480V	3P+G	22-38043
480V	3P+N+G	22-34047	480V	3P+N+G	22-38047
600V	2P+G	22-34142	600V	2P+G	22-38142
600V	3P+G	22-34143	600V	3P+G	22-38143
600V	3P+N+G	22-34147	600V	3P+N+G	22-38147

Receptacle Options	Part #
With 2 Auxiliary/Pilot Contacts*	Recept # - 972
Padlock Pawl	Recept # - 843
Metal Pawl on Poly Receptacle	Recept # - 924
Closed Lid Configuration	Recept # - R
180° Lid Opening	Recept # - 180

Inlet Options	Part #
With 2 Auxiliary/Pilot Contacts*	Inlet # - 972
No Lockout Hole	Inlet # - A155

* Not available with 600V devices, use -972-S74 for 550VAC.

IEC/CE DXN3

- Current** 32A, 50 Hz
- Environmental** IP66/IP67
- Ambient Temp** -40°C to +60°C
- Hazardous Location Ratings**
ATEX/IECEx Zones 1 & 2, 21 & 22

MARECHAL ELECTRIC MAROMME
Ex II 2 G/D Ex de IIC T*Gb
Ex tb IIIC T*Db
-40 °C ≤ TA ≤ +60 °C T5 T77 °C
-40 °C ≤ TA ≤ +40 °C T6 T57 °C
IECEx LCI 09.0006X / LCIE 05 ATEX 6149

See MELTRIC's International Catalog (online) for additional product information.

Receptacle

Inlet

IEC/CE Configurations (ATEX/IECEx)

Voltage	Polarity	Part #	Voltage	Polarity	Part #
20 - 24 V	2P	25-3408A	20 - 24 V	2P	25-3808A
190 - 230 V	3P+E	25-34033	190 - 230 V	3P+E	25-38033
220 - 250 V	1P+N+E	25-34015	220 - 250 V	1P+N+E	25-38015
380 - 440 V	3P+E	25-34013	380 - 440 V	3P+E	25-38013
380 - 440 V	3P+N+E	25-34017	380 - 440 V	3P+N+E	25-38017
480 - 500 V	3P+E	25-34093	480 - 500 V	3P+E	25-38093
480 - 500 V	3P+N+E	25-34097	480 - 500 V	3P+N+E	25-38097

Receptacle Options	Part #	Receptacle Options	Part #
Padlock Pawl w/shaft for 3 locks	Recept # + 844	Self-returning Lid	Recept # + R
180° Opening Lid	Recept # + 10	180° Opening & Self-returning Lid	Recept # + 18
With 2 Auxiliary/Pilot Contacts	Recept # + 972	Inlet # + 972	

Installation Accessories

Accessories rated for hazardous locations are not returnable.

Handles



Cable Range	Poly Handle w/Bushing ⁺	NPT	Poly Handle w/NPT ^{***}
.31 - .51	22-3A013-20P ⁺	3/4"	22-3A013-34 ^{***}
.51 - .75	22-3A013-25P ⁺	1"	22-3A013-1 ^{***}
.67 - .98	22-3A013-32P ⁺		
.95 - 1.26	22-3A013-40P ⁺		

⁺ ATEX rated for use in Zone 1/21, not listed for Class I or II, Division 2.
^{***} For use in Class I or II, Division 2 or Zone 1/21 depending on fitting used. Fitting manufactured by others.

Angles



Nylon 30° Angle
22-3A027

NPT Guidelines

Cable Range	NPT
.438 - .812	3/4"
.660 - 1.000	1"

NPT sizes are determined by the cable diameter and third party cord grip.

Wall Boxes



Cable Range	Poly 70° ⁺⁺ Wall Box	NPT	Poly 30°* Wall Box	Poly 30°** Wall Box	Poly 70°*** Alum Wall Box
.472 - .708	22-3AB58	1/2"	-	-	22-3A058-12
		3/4"	22-3A023-34-T	22-3A023-34-B	22-3A058-34
		1"	-	-	22-3A058-1
		1 1/4"	-	-	22-3A058-114
		1 1/2"	-	-	22-3A058-112

Will be discontinued in 2017 - contact customer service for availability.

⁺ Interior volume with receptacle installed.
⁺⁺ Poly cord grip is located on the top of box. For bottom cord entry, rotate the box 180°.
^{*} NPT thread on top.
^{**} NPT thread on bottom.
^{***} NPT is drilled on top of aluminum box as standard. For NPT on side only, add an "L" suffix. To switch from top to bottom or left to right the box can be rotated 180°.

Miscellaneous Accessories



Finger* Drawplates	Protective Cap	Receptacle ⁺ Lockout Pin
61-3A346	22-3A426	LP-843

* Recommended for cord to cord assembly applications, for easier connector closure.
⁺ Requires Padlockable Pawl option (-843) on receptacle.

Angles (ATEX/IECEX)



* For panel mounting. Not a replacement part for 70° wall box.

Inclined Poly 30°	Inclined Poly 70°*
25-3A027	25-3A757

Boxes (ATEX/IECEX)



Ex cable gland	Wall Box Poly 30°
M20	25-3AB53
M25	25-3AB53-25P
M32	-

COMING SOON

160x160 w/o terminal blocks*	Wall Box Poly 30°	160x160 w/10mm ² terminal blocks**	Wall Box Poly 30°
7-14 mm	25-3AB88-20P	25-3A088-20P	
10-18 mm	25-3AB88-25P	25-3A088-25P	
17-24 mm	25-3AB88-32P	25-3A088-32P	

* With earth continuity + 1 hole with a poly cable gland.
^{**} With 2 holes (1 with a cable gland + 1 with a stopping plug), with 8+2E 10 mm² terminals blocks + 6 mm² wires, wiring 6-10 mm². For loop in loop out wiring.

Handles (ATEX/IECEX)



Ex cable gland	Straight Poly with Poly Cable Gland	Straight Poly with Metal Cable Gland
M20	25-3A753	7-14 mm 25-3A253-20M 8-10 mm
M25	25-3A783	10-18 mm 25-3A253-25M 12-14 mm
M32	25-3A253-32P	17-24 mm 25-3A253-32M 18-24 mm
M40	25-3A253-40P	17-31 mm - -

DXN60 DXN6



DXN – 60A Hazardous Location Plugs & Receptacles

Devices rated for hazardous locations are not returnable.

SP US Ratings DXN60/DXN6

- Max Amperage & Voltage**
60A, 600 VAC, 60 Hz
- Current Interruption Capability**
For current interrupting (AC)
- Horsepower Ratings**
 - 120V 1Ø 2 hp
 - 240V 3Ø 7.5 hp
 - 480V 3Ø 20 hp
 - 600V 3Ø 20 hp
- Wiring Capacity**
Min 10 AWG Max 4 AWG
Aux Contacts - Max 10 AWG
* Based on THHN wire sizes
- Applicable Standards**
CSA C22.2 No. 182.1
- Hazardous Location Ratings**

-40°C ≤ Ta ≤ +60°C
Ex de IIC T4 Gb Ex tb IIIC T100°C Db
Class I Zone1 AEx de IIC T4 Gb
Zone 21 AEx tD T100°C Db
Class I Div 2 Gr A,B,C,D
Class II Div 2 Gr E,F,G
cCSAus 00.1144106X

Receptacle



Receptacles & Inlets must be mounted to a DXN handle, angle or wall box.



Standard DXN20 lid opens to 120°

Inlet



North American Configurations (cCSAus)

Voltage	Polarity	Part # Poly	Voltage	Polarity	Part # Poly
120V	1P+N+G	22-64165	120V	1P+N+G	22-68165
125V	1P+N+G	22-64075	125V	1P+N+G	22-68075
208V	2P+G	22-64162	208V	2P+G	22-68162
208V	3P+G	22-64163	208V	3P+G	22-68163
208V	3P+N+G	22-64167	208V	3P+N+G	22-68167
250V	2P+G	22-64072	250V	2P+G	22-68072
250V	3P+G	22-64073	250V	3P+G	22-68073
250V	2P+N+G	22-64076	250V	2P+N+G	22-68076
277V	1P+N+G	22-64045	277V	1P+N+G	22-68045
480V	2P+G	22-64042	480V	2P+G	22-68042
480V	3P+G	22-64043	480V	3P+G	22-68043
480V	3P+N+G	22-64047	480V	3P+N+G	22-68047
600V	2P+G	22-64142	600V	2P+G	22-68142
600V	3P+G	22-64143	600V	3P+G	22-68143
600V	3P+N+G	22-64147	600V	3P+N+G	22-68147

Receptacle Options	Part #	Inlet Options	Part #
With 2 Auxiliary/Pilot Contacts*	Recept # - 972	With 2 Auxiliary/Pilot Contacts*	Inlet # - 972
Padlock Pawl	Recept # - 843	No Lockout Hole	Inlet # - A155
Metal Pawl on Poly Receptacle	Recept # - 924	* Not available with 600V devices, use -972-S74 for 550 VAC.	
Closed Lid Configuration	Recept # - R		
180° Lid Opening	Recept # - 180		

IEC/CE DXN6

- Current** 63A, 50 Hz
- Environmental** IP66/IP67
- Ambient Temp** -40°C to +60°C
- Hazardous Location Ratings**
ATEX/IECEx Zones 1 & 2, 21 & 22

MARECHAL ELECTRIC MAROMME
Ex de IIC T*Gb
Ex tb IIIC T*Db
-40 °C ≤ TA ≤ +60 °C T4 T107 °C
-40 °C ≤ TA ≤ +40 °C T5 T87 °C
IECEx LCI 09.0007 / LCIE 05 ATEX 6150

See MELTRIC's International Catalog (online) for additional product information.

Receptacle

IEC/CE Configurations (ATEX/IECEx)

Voltage	Polarity	Part #	Voltage	Polarity	Part #
20 - 24 V	2P	25-6408A	20 - 24 V	2P	25-6808A
190 - 230 V	3P+E	25-64033	190 - 230 V	3P+E	25-68033
220 - 250 V	1P+N+E	25-64015	220 - 250 V	1P+N+E	25-68015
380 - 440 V	3P+E	25-64013	380 - 440 V	3P+E	25-68013
380 - 440 V	3P+N+E	25-64017	380 - 440 V	3P+N+E	25-68017
480 - 500 V	3P+E	25-64093	480 - 500 V	3P+E	25-68093
480 - 500 V	3P+N+E	25-64097	480 - 500 V	3P+N+E	25-68097

Receptacle Options	Part #	Receptacle Options	Part #
Padlock Pawl w/shaft for 3 locks	Recept # + 844	Self-returning Lid	Recept # + R
180° Opening Lid	Recept # + 10	180° Opening & Self-returning Lid	Recept # + 18
With 2 Auxiliary/Pilot Contacts	Recept # + 972	Inlet # + 972	

Installation Accessories

Accessories rated for hazardous locations are not returnable.

Handles



Cable Range	Poly Handle w/Bushing*	NPT	Poly Handle w/NPT***
.51 - .75	22-6A013-25P+	1"	22-6A013-1***
.67 - .98	22-6A013-32P+		
.95 - 1.26	22-6A013-40P+		

+ ATEX rated for use in Zone 1/21, not listed for Class I or II, Division 2.

*** For use in Class I or II, Division 2 or Zone 1/21 depending on fitting used. Fitting manufactured by others.

Angles



Nylon 30° Angle

22-6A027

NPT Guidelines

Cable Range	NPT
.660 - 1.000	1"

NPT sizes are determined by the cable diameter and third party cord grip.

Wall Boxes



Cable Range	Poly 70°** Wall Box	NPT	Poly 30°* Wall Box	Poly 30°** Wall Box	Poly 70°*** Alum Wall Box
.629 - .984	22-6AB58	1/2"	-	-	22-6A058-12
		3/4"	-	-	22-6A058-34
		1"	22-6A023-1-T	22-6A023-1-B	22-6A058-1
		1 1/4"	-	-	22-6A058-114
		1 1/2"	-	-	22-6A058-112

Will be discontinued in 2017 - contact customer service for availability.

Miscellaneous Accessories



For Male Devices Only

Finger* Drawplates	Protective Cap	Receptacle* Lockout Pin
61-6A346	22-6A426	LP-843

* Recommended for cord to cord assembly applications, for easier connector closure.

+ Requires Padlockable Pawl option (-843) on receptacle.

+ Interior volume with receptacle installed.
 ** Poly cord grip is located on the top of box.
 For bottom cord entry, rotate the box 180°.

* NPT thread on top.

** NPT thread on bottom.

*** NPT is drilled on top of aluminum box as standard. For NPT on side only, add an "L" suffix. To switch from top to bottom or left to right the box can be rotated 180°.

Angles (ATEX/IECEX)



* For panel mounting. Not a replacement part for 70° wall box.

Inclined Poly 30°	Inclined Poly 70°*
25-6A027	25-6A757

Boxes (ATEX/IECEX)



Ex cable gland	Wall Box Poly 30°
M20	-
M25	25-6AB53
M32	-
M40	-

COMING SOON

160x160 w/o terminal blocks*



160x160 w/16mm² terminal blocks**

	Wall Box Poly 30°	Wall Box Poly 30°
7-14 mm	25-6AB88-20P	25-6A088-20P*
10-18 mm	25-6AB88-25P	25-6A088-25P*
17-24 mm	25-6AB88-32P	25-6A088-32P*
17-31 mm	25-6AB88-40P	25-6A088-40P*

* With earth continuity + 1 hole with a poly cable gland.

** With 2 holes (1 with a cable gland + 1 with a stopping plug), with 8+2E 16 mm² terminals blocks + 16 mm² wires, wiring 16 mm². For loop in loop out wiring.

+ -40°C ≤ Ta ≤ +55°C T4 T105°C
 -40°C ≤ Ta ≤ +50°C T5 T95°C

Handles (ATEX/IECEX)



with Earth continuity

Ex cable gland	Straight Poly with Poly Cable Gland		Straight Poly with Metal Cable Gland	
M20	25-6A253-20P	7-14 mm	25-6A253-20M	8-10 mm
M25	25-6A753	10-18 mm	25-6A253-25M	12-14 mm
M32	25-6A253-32P	17-24 mm	25-6A253-32M	18-24 mm
M40	25-6A253-40P	17-31 mm	-	-

DXN



Dimensions

Inlet – Provided in inches

Dimensions are for reference only and may change depending on accessories used. For precise dimensions contact MELTRIC Engineering.

plug

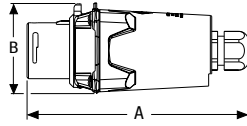

PRODUCT	A	B
DXN20	6.36	2.40
DXN30	6.47	2.83
DXN60	9.67	3.02

Inlet

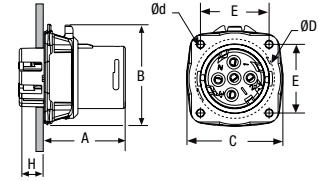

PRODUCT	A	C	E	H	Ød	ØD
DXN20	1.86	2.20	1.65	0.71	0.18	1.65
DXN30	1.97	2.63	1.89	1.06	0.19	2.18
DXN60	2.19	3.00	2.17	1.75	0.20	2.25

30° inclined inlet/angle with connector

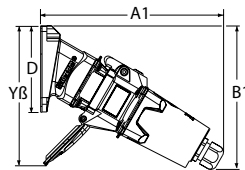

PRODUCT	A1	B1	D	YB
DXN20	7.52	5.91	3.54	5.75
DXN30	8.07	6.57	4.25	6.10
DXN60	9.41	7.48	4.00	9.02

30° inlet/angle

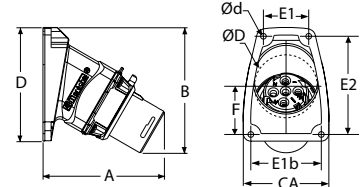

PRODUCT	A	B	CA	D	E1	E1b	E2	Ød	ØD
DXN20	3.74	3.94	2.68	3.54	1.42	1.42	3.07	0.18	2.00
DXN30	3.90	4.53	3.00	4.25	2.48	2.48	3.74	0.22	2.50
DXN60	4.29	4.88	3.00	4.25	2.48	2.48	3.74	0.22	2.50

30° inclined inlet/conduit box with connector

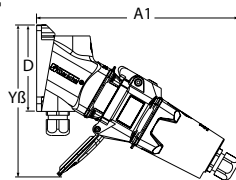

PRODUCT	A1	D	YB
DXN20	8.23	3.54	6.22
DXN30	8.70	4.25	7.80
DXN60	10.43	4.25	8.43

30° inlet/conduit box

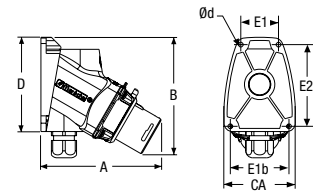

PRODUCT	A	B	CA	D	E1	E1b	E2	Ød
DXN20	4.53	4.37	2.68	3.54	1.42	2.20	3.07	0.18
DXN30	4.53	4.29	3.00	4.25	2.50		3.76	0.22
DXN60	5.35	5.04	3.00	4.25	2.50		3.76	0.22

70° inclined inlet/wall box with connector

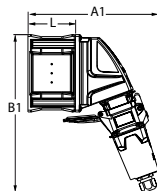

PRODUCT	A1	B1	L
DXN20	8.43	10.16	3.07
DXN30	8.62	10.90	3.07
DXN60	9.88	13.66	3.07

70°inlet/wall box

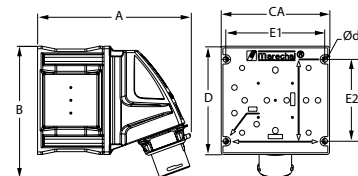

PRODUCT	A	B	CA	D	E1	E2	Ød
DXN20	7.05	6.06	4.97	4.97	4.57	3.78	0.26
DXN30	7.20	6.26	5.04	5.04	4.57	3.72	0.26
DXN60	8.27	7.99	6.69	6.69	6.14	5.43	0.26

Dimensions

Receptacle – Provided in inches

Dimensions are for reference only and may change depending on accessories used. For precise dimensions contact MELTRIC Engineering.

connector

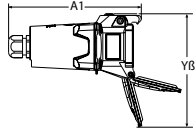

PRODUCT	A1	YB
DXN20	6.22	5.28
DXN30	7.17	7.05
DXN60	8.31	7.68

receptacle with plug

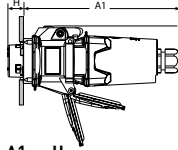

PRODUCT	A1	H
DXN20	6.50	0.68
DXN30	7.24	1.17
DXN60	8.58	1.18

receptacle

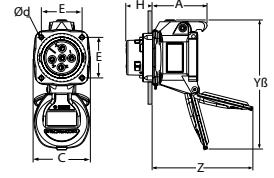

PRODUCT	A	C	E	H	YB	Z	Ød
DXN20	2.60	2.19	1.65	0.68	5.28	4.09	0.18
DXN30	2.93	2.60	1.89	1.20	7.05	4.29	0.20
DXN60	3.11	3.31	2.17	1.27	7.68	5.91	0.20

30° inclined receptacle/angle with plug

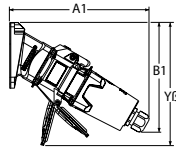

PRODUCT	A1	B1	YB
DXN20	7.52	5.91	6.65
DXN30	8.07	6.57	7.68
DXN60	9.41	7.48	8.62

30° receptacle/angle

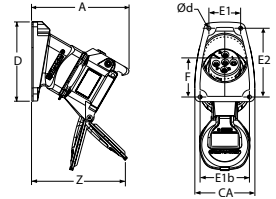

PRODUCT	A	CA	D	E1	E1b	E2	F	Z	Ød
DXN20	4.37	2.68	3.54	1.42	2.20	1.50	1.73	4.29	0.18
DXN30	5.08	3.03	4.25	2.50		2.75	1.46	4.64	0.23
DXN60	5.35	3.03	4.25	2.50		3.74	1.57	5.47	0.22

30° inclined receptacle/conduit box with plug

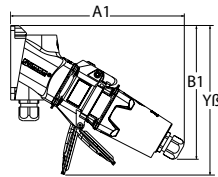

PRODUCT	A1	B1	YB
DXN20	8.23	6.38	7.09
DXN30	8.70	6.34	7.44
DXN60	10.43	7.68	8.86

30° receptacle/conduit box

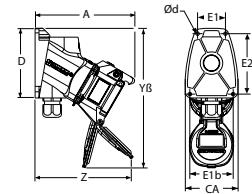

PRODUCT	A	CA	D	E1	E1b	E2	Z	Ød
DXN20	5.08	2.68	3.54	1.42	2.20	3.07	5.00	0.18
DXN30	5.71	3.24	3.25	2.50		3.75	6.30	0.22
DXN60	6.38	3.50	3.94	2.50		3.75	6.50	0.22

70° inclined receptacle/wall box with plug

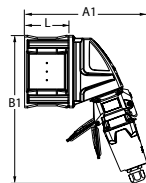

PRODUCT	A1	B1	L
DXN20	8.43	10.16	3.07
DXN30	8.43	10.91	3.07
DXN60	9.80	13.66	3.07

70° receptacle/wall box

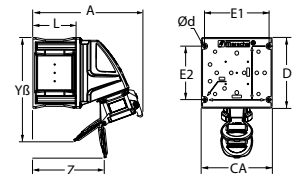

PRODUCT	A	CA	D	E1	E2	L	YB	Z	Ød
DXN20	7.80	4.97	4.97	4.57	3.78	3.07	7.36	5.20	0.26
DXN30	8.27	5.04	5.04	4.57	3.78	3.07	6.97	5.50	0.26
DXN60	9.21	6.69	6.69	6.14	5.47	3.07	9.45	5.75	0.26



Coming
SOON

Product Features



Locking Provision

For insertion of locking pin (or padlock) to prevent inadvertent disconnection.

Metal Casing

Provides excellent durability and protection.

Lid

Provides additional protection from harsh environments.

IP66/IP67 Watertightness

Environmental rating is achieved as soon as the plug is latched to the receptacle. There is no additional ring to tighten.

Silver-Nickel Contacts

Silver-nickel contact material provides superior conductivity, durability and corrosion resistance.

Spring Loaded Butt-Style Contacts

Ensures optimal contact force and superior electrical performance over thousands of operations.

Hazardous Duty Listings

ATEX

II 2 G D Ex de IIC T*Gb Ex tb IIIC T* Db

-55°C <Ta< 40°C T6 T68°C

-55°C <Ta< 60°C T5 T88 °C

LCIE 15 ATEX 3033 / IECEx LCIE 15.0030



The DXA product line is similar to the DXN, but uses a larger casing made of aluminum and equipped with dual pawls for use in more abusive and colder environments.

CSA CUS North American certifications are in process. Please contact customer service for estimated availability dates.

Visit meltric.com/dxa for updated ratings.

DXA1 – 20A

Hazardous Location Plugs & Receptacles

Devices/Accessories rated for hazardous locations are not returnable.



Plug
(Male)



Plug/30° Angle
(Male)



Plug/Wall Box
(Male)



North American Configurations

Available Voltages	Available Polarity	Part Numbers
120V, 125V, 277V	1P+N+G	Visit meltric.com/dxa for updated part numbers and ratings.
208V, 250V, 480V	2P+G	
208V, 250V, 480V	3P+G	
208V, 480V	3P+N+G	

Connector
(female receptacle w/handle)



Receptacle/30° Angle
(female)



Receptacle/Wall Box
(female)



North American Configurations

Available Voltages	Available Polarity	Part Numbers
120V, 277V	1P+N+G	Visit meltric.com/dxa for updated part numbers and ratings.
125V, 480V	2P+G	
208V, 600V	3P+G	
250V	3P+N+G	

Ratings

- **Voltage**
550 VAC
- **Current Interruption Capacity**
20A For current interrupting (AC)
- **Environmental Ratings**
IP66/IP67
- **Temperature Range**
Min -67°F / Max 140°F
- **Wiring Capacity**
Min 16 AWG Max 10 AWG
* Based on THHN wire sizes
- **Listings**
ATEX/IECEX Zones 1 & 2, 21 & 22
CSA Pending

XXX Suffix / Cable Range

XXX (Suffix #)	Cable Range
-25M	9 - 16 mm
-32M	12 - 21 mm

8-13 mm cable range is standard (if no suffix is ordered). For larger cables use suffixes above.

Accessories & Options

	Inlet Cap
Part #	29-1A426
	Padlock Pawl
Part #	Recept # - 843

Plug
(Male)

Plug/30° Angle
(Male)

Plug/Wall Box
(Male)

IEC/CE Configurations (ATEX/IECEX)

Voltage	Polarity	Part # Metal	Voltage	Polarity	Part # Metal	Voltage	Polarity	Part # Metal
220 - 250 V	2P	29-11015-XXX	220 - 250 V	2P	29-19015	220 - 250 V	2P	29-16015-XXX
380 - 440 V	3P+E	29-11013-XXX	380 - 440 V	3P+E	29-19013	380 - 440 V	3P+E	29-16013-XXX
380 - 440 V	1P+N+E	29-11017-XXX	380 - 440 V	1P+N+E	29-19017	380 - 440 V	1P+N+E	29-16017-XXX

Connector
(female receptacle w/handle)

Receptacle/30° Angle
(female)

Receptacle/Wall Box
(female)

IEC/CE Configurations (ATEX/IECEX)

Voltage	Polarity	Part # 30° Metal	Voltage	Polarity	Part # 30° Metal	Voltage	Polarity	Part # 30° Metal
220 - 250 V	1P+N+T	29-13015-XXX	220 - 250 V	1P+N+T	29-17015	220 - 250 V	1P+N+T	29-10015-XXX
380 - 440 V	3P+T	29-13013-XXX	380 - 440 V	3P+T	29-17013	380 - 440 V	3P+T	29-10013-XXX
380 - 440 V	3P+N+T	29-13017-XXX	380 - 440 V	3P+N+T	29-17017	380 - 440 V	3P+N+T	29-10017-XXX

HAZARDOUS
LOCATION

REFERENCE

DS60 DSN150

NEW
Model



Features and Ratings

p. 190

DS60

p. 191

DSN150

p. 193



Hazardous location rated plugs and receptacles

Metal DS60 and metal DSN150 plugs and receptacles are available for hazardous-rated Class I, Division 2 / Zone 2 environments. The devices are horsepower rated to meet code requirements for motor connections. Type 4X watertightness ratings are automatically achieved as soon as the plug mates with the receptacle.

Main Advantages

- ▶ Featuring silver nickel, butt-style contacts for maximum performance and durability
- ▶ Available in in-line and wall/panel mounted configurations
- ▶ Ideal for motor connections up to 75 hp

Product Features



General Ratings

Amperage	60 and 150A
Voltage	600 VAC
Frequency	60 Hz
Horsepower	2 to 75 hp
Environmental	Type 4X
Temperature	min -40°F/max 104°F

Hazardous Duty Listings

CSA
Class I Division 2 Groups ABCD, T6
Class I Zone 2, IIC

Plug & Receptacle Listings (CSA)

Category	CSA
Plugs and Receptacles	C22.2 No. 182.1
Electrical Equipment for Class I, Div 2 Locations	C22.2 No. 213-M1987

Highlighted Feature

Typical Device Labels

Meltric DSN150
150A, 480VAC
75hp, TYPE 4X
1002001
66-94043
RECEPTACLE/CONNECTOR
Class I, Division 2, Groups ABCD, T6
Class I, Zone 2, IIC

Meltric DS60
60A, 480VAC
20hp, TYPE 4X
1002001
36-64043
RECEPTACLE/CONNECTOR
Class I, Division 2, Groups ABCD, T6
Class I, Zone 2, IIC

DS60 and DSN150 plugs and receptacles are CSA horsepower rated for motor connections in hazardous locations. Not for current interrupting.

Operating Instructions



Before connection, ensure that the circuit is deenergized. Align the red dots, push the plug partially in, then turn clockwise slightly to line up the latch with the catch.



Push the plug fully home until it is held in place by the latch. The circuit is now closed.



Safety requirement: Tighten screw to lock the plug in the mated position.



Optional: Insert a 5/16" lock or locking pin to prevent disconnection or to lock the receptacle lid closed.

DS60



DS – 60A Hazardous Location Plugs & Receptacles

Devices rated for hazardous locations are not returnable.

SP US Ratings

- Voltage**
600 VAC
- Current Interruption Capability**
Not for current interrupting
- Horsepower Ratings**

120V	1Ø	2 hp
240V	1Ø	3 hp
208V	3Ø	7 1/2 hp
240V	3Ø	10 hp
480V	3Ø	20 hp
600V	3Ø	25 hp
- Short Circuit Rating**
100kA Close & Withstand
Testing was performed with RK1 current limiting fuses sized at 400% of the highest full load motor ampacity associated with the devices hp rating.
- Environmental Ratings**
Type 4X
- Temperature Range**
Min -40°F/Max 104°F
See pg 234 for temps below -15°F.
- Wiring Capacity**
Min 10 AWG Max 2 AWG
Aux Contacts - Max 14 AWG
- Applicable Standards**
CSA C22.2 No. 182.1
CSA 213-M1987
- Hazardous Ratings**
Class I, Division 2, Groups ABCD, T6
Class I, Zone 2, IIC



Receptacle



Don't forget to add installation accessories to your order

Standard DS60 Zone 2 lid is normally closed

Inlet



North American Configurations (cCSAus)

Voltage	Polarity	Part # Metal
120V	1P+N+G	36-64165
120/208V	3P+N+G	36-64167
125V	1P+N+G	36-64075
125/250V	2P+N+G	36-64076
208V	2P+G	36-64162
208V	3P+G	36-64163
250V	2P+G	36-64072
250V	3P+G	36-64073
277V	1P+N+G	36-64045
277/480V	3P+N+G	36-64047
347/600V	3P+N+G	36-64147
480V	2P+G	36-64042
480V	3P+G	36-64043
600V	2P+G	36-64142
600V	3P+G	36-64143

Voltage	Polarity	Part # Metal
120V	1P+N+G	36-68165
120/208V	3P+N+G	36-68167
125V	1P+N+G	36-68075
125/250V	2P+N+G	36-68076
208V	2P+G	36-68162
208V	3P+G	36-68163
250V	2P+G	36-68072
250V	3P+G	36-68073
277V	1P+N+G	36-68045
277/480V	3P+N+G	36-68047
347/600V	3P+N+G	36-68147
480V	2P+G	36-68042
480V	3P+G	36-68043
600V	2P+G	36-68142
600V	3P+G	36-68143

Receptacle Options

Suffix

- With 2 Auxiliary/Pilot Contacts Recept # - 972
- Normally Open Lid Configuration Recept # - NO

Inlet Options

Suffix

- With 2 Auxiliary/Pilot Contacts Inlet # - 972
- With No Lockout Hole Inlet # - A155

Feature Spotlight – Screw-Type Locking Pawl

Safety Requirement
Users must tighten screw to lock the plug in the mated position



DS60 Division 2 / Zone 2 receptacles feature a standard screw-type locking pawl. This required feature allows the user to lock the plug to the receptacle by tightening a screw on the pawl.

For added security, a lockout hole is included on the receptacle that enables the user to insert a 5/16" lock or locking pin to prevent the plug from being disconnected or to lock the receptacle lid closed.

5/16" hole for added security

See pgs 211-220 for detailed information on these options

Installation Accessories

Accessories rated for hazardous locations are not returnable.

Handles



NPT	Metal Handle
1/2"	6H12M
3/4"	6H34M
1"	6H1M
1 1/4"	6H114M
1 1/2"	6H112M

Notes: • For available third party cord grips, consult factory.

Angles



Metal 30° Angle	Metal 70° Angle	Metal Straight Adapter	Metal Lateral Angle 30°
MA6M	89-6A027M	MS6M	MAB6M

Junction Boxes



NPT	Metal Box
1/2"	-
3/4"	-
1"	MB61M
1 1/4"	MB6114M
1 1/2"	MB6112M
2"	MB62M

Miscellaneous Accessories



* Set of Two (2)

For Male Devices Only

For Male Devices Only

Finger Drawplates	Protective Cap	Padlockable Cap Aluminum	Receptacle+ Locking Pin
FDP6	31-6A426	DS6MC	LP-843

* Recommended for cord to cord assembly applications, for easier connector closure.
 + Requires Padlockable Pawl option (-843) on receptacle.

NPT Guidelines

Cable Range	NPT
.312 - .625	1/2"
.438 - .812	3/4"
.660 - 1.000	1"
.875 - 1.375	1 1/4"
.890 - 1.812	1 1/2"

NPT sizes are determined by the cable diameter and third party cord grip.

Accessory Spotlight

Receptacle Lockout Pin



A 5/16" lockout pin can be ordered to securely lockout receptacles that include the 'padlockable pawl' option. Alternatively the user can utilize a lock with a 5/16" shank. Locks with smaller shanks will NOT securely lockout a receptacle pawl.

Order Example

A typical order should include an inlet part number, a receptacle part number **AND** the matching handles, angles or other required accessories.



Male Inlet with Handle (Plug)
36-68043 + 6H12M



Female Receptacle with Angle Adapter
36-64043 + MA6M

DSN150



DSN – 150A

Hazardous Location Plugs & Receptacles

Devices rated for hazardous locations are not returnable.

SP US Ratings

- Voltage**
600 VAC
- Current Interruption Capability**
Not for current interrupting
- Horsepower Ratings**
 - 120V 1Ø 7 1/2 hp
 - 240V 1Ø 20 hp
 - 208V 3Ø 30 hp
 - 240V 3Ø 30 hp
 - 480V 3Ø 75 hp
 - 600V 3Ø 75 hp
- Short Circuit Rating**
100kA Close & Withstand
Testing was performed with 225A RK1 non-time delay Mersen fuses.
10kA Close & Withstand
Testing was performed with 400A RK1 non-time delay Mersen fuses.
- Environmental Ratings**
Type 4X
- Temperature Range**
Min -40°F/Max 104°F
See pg 234 for temps below -15°F.
- Wiring Capacity**
Min 4 AWG Max 2/0 AWG
Aux Contacts - Max 14 AWG
- Applicable Standards**
CSA C22.2 No. 182.1
CSA 213-M1987
- Hazardous Ratings**
Class I, Division 2, Groups ABCD, T6
Class I, Zone 2, IIC

Receptacle



Easy Closing Mechanism



Inlet



North American Configurations (cCSAus)

Voltage	Polarity	Part # Metal
120V	1P+N+G	66-94165
120/208V	3P+N+G	66-94167
125V	1P+N+G	66-94075
125/250V	2P+N+G	66-94076
208V	2P+G	66-94162
208V	3P+G	66-94163
250V	2P+G	66-94072
250V	3P+G	66-94073
277V	1P+N+G	66-94045
277/480V	3P+N+G	66-94047
347/600V	3P+N+G	66-94147
480V	2P+G	66-94042
480V	3P+G	66-94043
600V	2P+G	66-94142
600V	3P+G	66-94143

Voltage	Polarity	Part # Metal
120V	1P+N+G	66-98165
120/208V	3P+N+G	66-98167
125V	1P+N+G	66-98075
125/250V	2P+N+G	66-98076
208V	2P+G	66-98162
208V	3P+G	66-98163
250V	2P+G	66-98072
250V	3P+G	66-98073
277V	1P+N+G	66-98045
277/480V	3P+N+G	66-98047
347/600V	3P+N+G	66-98147
480V	2P+G	66-98042
480V	3P+G	66-98043
600V	2P+G	66-98142
600V	3P+G	66-98143

Receptacle Options

Suffix

With 2 Auxiliary/Pilot Contacts	Recept # - 262
With 3 Auxiliary/Pilot Contacts	Recept # - 263
With 4 Auxiliary/Pilot Contacts	Recept # - 264
With 5 Auxiliary/Pilot Contacts	Recept # - 975
With 6 Auxiliary/Pilot Contacts	Recept # - 976
180° Opening Lid	Recept # - 180**
Normally Open Lid Configuration	Recept # - NO

Inlet Options

Suffix

With 2 Auxiliary/Pilot Contacts	Inlet # - 262
With 3 Auxiliary/Pilot Contacts	Inlet # - 263
With 4 Auxiliary/Pilot Contacts	Inlet # - 264
With 5 Auxiliary/Pilot Contacts	Inlet # - 975
With 6 Auxiliary/Pilot Contacts	Inlet # - 976
With No Lockout Hole	Inlet # - A155

Notes: ** Required when mating to panel mounted male inlet.

Feature Spotlight – Screw-Type Locking Pawl



Safety Requirement
Users must tighten screw to lock the plug in the mated position

5/16" hole for added security

DSN150 Division 2 / Zone 2 receptacles feature a standard screw-type locking pawl. This required feature allows the user to lock the plug to the receptacle by tightening a screw on the pawl. For added security, a lockout hole is included on the receptacle that enables the user to insert a 5/16" lock or locking pin to prevent the plug from being disconnected or to lock the receptacle lid closed.



See pgs 211-220 for detailed information on these options

Installation Accessories

Accessories rated for hazardous locations are not returnable.

Handles



NPT	Metal Handle	Oversized Metal Handle
3/4"	9H34M	9MH34M
1"	9H1M	9MH1M
1 1/4"	9H114M	9MH114M
1 1/2"	9H112M	9MH112M
2"	9H2M	9MH2M
2 1/2"	-	9MH212M

Notes: • For available third party cord grips, consult factory.

Angles



Metal 30° Angle	Metal 70° Angle	Metal Straight Adapter
MA10M	89-9A027M	MS10M

Junction Boxes



NPT	Metal Box	Metal Box with Metal Angle
1 1/4"	MB10114M	39-9A053-080-114M
1 1/2"	MB10112M	39-9A053-080-112M
2"	MB102M	39-9A053-080-2M
2 1/2"	MB10212M	39-9A053-080-212M

+ Interior volume with receptacle installed.

Miscellaneous Accessories



For Male Devices Only



Padlockable Cap Aluminum	Cord Grip with Mesh	Receptacle Locking Pin
DS9MC	consult factory	LP-843

NPT Guidelines

Cable Range	NPT	Cable Range	NPT
.312 - .625	1/2"	.890 - 1.812	1 1/2"
.438 - .812	3/4"	1.190 - 2.438	2"
.660 - 1.000	1"	2.062 - 2.438	2 1/2"
.875 - 1.375	1 1/4"		

NPT sizes are determined by the cable diameter and third party cord grip.

Accessory Spotlight

Receptacle Lockout Pin



A 5/16" lockout pin can be ordered to securely lockout receptacles that include the 'padlockable pawl' option. Alternatively the user can utilize a lock with a 5/16" shank. Locks with smaller shanks will NOT securely lockout a receptacle pawl.

Order Example

A typical order should include an inlet part number, a receptacle part number **AND** the matching handles, angles or other required accessories.



Male Inlet with Handle (Plug)
69-98043 + 9H1



Female Receptacle with Angle Adapter
69-94043 + MA10M

DX



Features and Ratings	p. 196
Certifications and Testing	p. 197
DX Operation	p. 198
DX20	p. 199
DX30	p. 200
DX60	p. 201
DX100	p. 202
Dimensions	p. 203



Hazardous duty rated plugs and receptacles

DX Series plugs and receptacles are heavy duty metallic devices that are a good choice for refineries, petroleum platforms, chemical and pharmaceutical plants, grain silos and other locations where exposure to flammable gases and/or dusts is likely to occur. DX's are ATEX and IECEx rated and they have also been tested and approved by ETL for operation under load in a gaseous environment (14.5% acetylene).

Main Advantages

- ▶ Rugged Construction, cost effective design
- ▶ Rated for Zone 1 and Zone 21 applications

Product Features



General Ratings

Amperage	20 to 100A
Voltage	600 VAC Max
Frequency	50-400 Hz
Environmental	IP65
Temperature	min -13°F/max 140°F* (DX20/DX30) min -40°F/max 140°F* (DX60/DX100)

Highlighted Feature

Dead Front

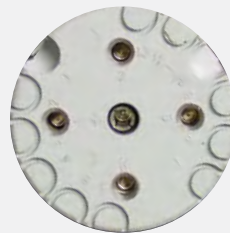

The dead front on the DX receptacle provides protection from accidental tool and wire insertion.

Operating Instructions



When a DX is connected there is total safety.



Pressing the pawl while turning the plug about 30° counterclockwise causes the circuit to be broken.



Press the pawl while withdrawing the plug from the receptacle. This is done in complete safety because the circuit is already dead.



The plug and receptacle are separated. The safety shutter prevents access to live parts.

5 To reconnect, insert plug into receptacle fully, then twist the plug approximately 30° clockwise to make the circuit.

DX Certifications

Hazardous Duty Certification

ATEX and IECEx

II 2 G/D DUST T85°C* Ex de IIC T6*

II – Indicates suitability for installation in surface applications (as opposed to underground mine applications).

2 – Indicates suitability for use where a high level of protection is required and where the presence of an explosive atmosphere is likely to occur (Zone 1 and Zone 21 environments).

G/D – Indicates suitability for installation in areas that may contain flammable gases, vapors/mists, or dusts.

T85°C* – Indicates a maximum surface temperature of the product of 85°C, at 40°C ambient.

Ex de – Indicates that explosion protection is provided with (e) increased safety in the conductor termination area, and (d) explosion proof chambers for making and breaking the current that can withstand the pressure of internal ignition and that prevent arcs, flame or other ignition events from being communicated to the surrounding atmosphere.

IIC – Indicates suitability for installation in areas where exposure to any type of gas, including the most dangerous subdivision C gases may occur.

T6* – Temperature class – the maximum product surface temperature is 185°F (85°C) for ambient temperature of 104°F (40°C).

ATEX & IECEx certification was performed by LCIE.

* Temperature ratings vary depending on product and ambient temperature. See specific product section for temperature ratings.

Electrical Performance Testing

Key Performance Tests Passed				
Model	Mechanical Endurance	Electrical Endurance ¹	Overload Testing ²	Dielectric Test
DX20	-	5000 Operations	50 Operations	2 x V (rated) + 1000V
DX30	1000 Cycles	1000 Operations	50 Operations	2 x V (rated) + 1000V
DX60	1000 Cycles	1000 Operations	50 Operations	2 x V (rated) + 1000V
DX100	1000 Cycles	1000 Operations	50 Operations	2 x V (rated) + 1000V

¹ @ 100% of rated current and voltage and 0.6 power factor.

² @ 125% of rated current, 110% of rated voltage, & 0.6 power factor.

DX Operation

Connection

1

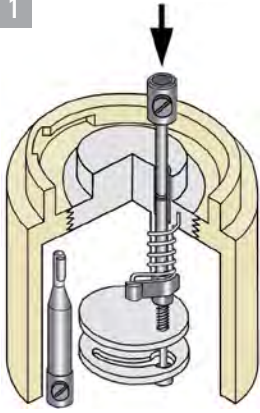

Insertion of the Plug

As the plug contact is inserted, it engages and depresses the 'dead' switching contact.

This releases the locking mechanism. The switching contact is free to operate.

2

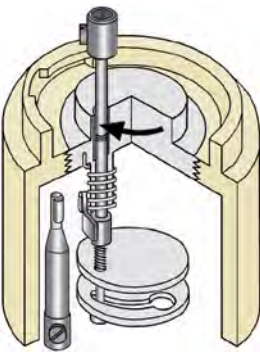

Charging the Operating Spring

Clockwise rotation of the inserted plug winds the operating spring and rotates the switching contact into position to engage with the live receptacle contact.

3

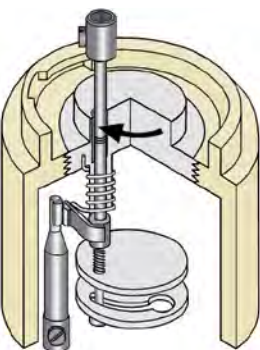

Making the Circuit

With the final few degrees of rotation, the switching contact is released and force from the spring quickly drives it into engagement with the live receptacle contact.

Disconnection

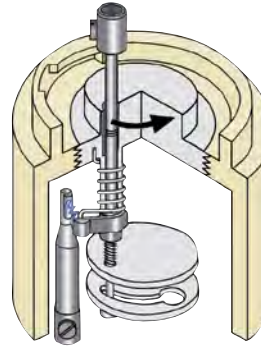

After depressing the pawl, the plug is rotated in a counter-clockwise direction. This frees the switching contact for operation and the release of the remaining spring tension causes a quick breaking of the contacts. The plug may now be removed, if desired.

Receptacle with Plug Disconnected

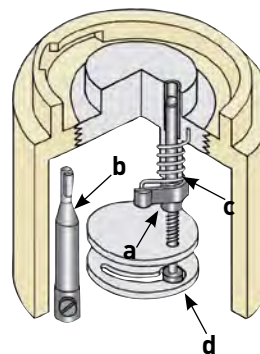

- a. **Switching Contact**
Shown in the open (dead) position
- b. **'Live' Receptacle Contact**
Accessibility is denied
- c. **Operating Spring**
Shown with tension released
- d. **Mechanical Locking Device**
Blocks contact operation

DX20



DX – 20A

Hazardous Location Plugs & Receptacles

Devices & accessories rated for hazardous locations are not returnable.

Ratings

- **Max Amperage & Voltage**
20A, 600 VAC
- **Environmental Ratings**
IP65
- **Temperature Range**
Min -13°F / Max 140°F
- **Wiring Capacity**
Min 14 AWG Max 8 AWG
* Based on THHN wire sizes
- **Applicable Standards**
ATEX, IECEx
- **Hazardous Location Ratings**

MARECHAL ELECTRIC MAROMME
 © II2 G/D Ex de IIC tD A21
 -25°C ≤ Ta ≤ +60°C T5 T84°C
 -25°C ≤ Ta ≤ +50°C T6 T74°C
 IECEx LCI 09.0014/LCIE 05 ATEX 6127

XXX Suffix / Cable Range

XXX (Suffix #)	Cable Range
-20M	.31" - .51"
-25M	.35" - .63"

XX Suffix / NPT Size

NPT Thread Size	XX (Suffix #)
1/2"	-12
3/4"	-34
1"	-1

NPT sizes are determined by the cable diameter and third party cord grip.

Accessories



Protective Cap

For Male Devices Only

Part #

DX20 26-2A126



Metal Wall Box

NPT

Part #

1/2" 26-2A023-12

3/4" 26-2A023-34

1" 26-2A023-1

Plug (male inlet w/handle)



Replace XXX or XX with suffix number to indicate desired cable range (see chart)

Inlet w/cap on box (male)



or

North American Configurations

Voltage	Polarity	Part # Metal
120V	1P+N+G	26-21165-XXX
125V	1P+N+G	26-21075-XXX
208V	2P+G	26-21162-XXX
208V	3P+G	26-21163-XXX
208V	3P+N+G	26-21167-XXX
250V	2P+G	26-21072-XXX
250V	3P+G	26-21073-XXX
250V	2P+N+G	26-21076-XXX
277V	1P+N+G	26-21045-XXX
480V	2P+G	26-21042-XXX
480V	3P+G	26-21043-XXX
480V	3P+N+G	26-21047-XXX
600V	3P+G	26-21143-XXX

Voltage	Polarity	Part # Metal
120V	1P+N+G	26-26165-XX
125V	1P+N+G	26-26075-XX
208V	2P+G	26-26162-XX
208V	3P+G	26-26163-XX
208V	3P+N+G	26-26167-XX
250V	2P+G	26-26072-XX
250V	3P+G	26-26073-XX
250V	2P+N+G	26-26076-XX
277V	1P+N+G	26-26045-XX
480V	2P+G	26-26042-XX
480V	3P+G	26-26043-XX
480V	3P+N+G	26-26047-XX
600V	3P+G	26-26143-XX

For international configurations (IEC/CE) visit meltric.com/international-catalog or contact customer service at 800.433.7642.

Connector (female recept w/handle) Receptacle on box (female) Receptacle (female)



or



or



North American Configurations

Voltage	Polarity	Part # Metal
120V	1P+N+G	26-23165-XXX
125V	1P+N+G	26-23075-XXX
208V	2P+G	26-23162-XXX
208V	3P+G	26-23163-XXX
208V	3P+N+G	26-23167-XXX
250V	2P+G	26-23072-XXX
250V	3P+G	26-23073-XXX
250V	2P+N+G	26-23076-XXX
277V	1P+N+G	26-23045-XXX
480V	2P+G	26-23042-XXX
480V	3P+G	26-23043-XXX
480V	3P+N+G	26-23047-XXX
600V	3P+G	26-23143-XXX

Part # Metal	Part # Metal
26-20165-XX	26-24165
26-20075-XX	26-24075
26-20162-XX	26-24162
26-20163-XX	26-24163
26-20167-XX	26-24167
26-20072-XX	26-24072
26-20073-XX	26-24073
26-20076-XX	26-24076
26-20045-XX	26-24045
26-20042-XX	26-24042
26-20043-XX	26-24043
26-20047-XX	26-24047
26-20143-XX	26-24143

For international configurations (IEC/CE) visit meltric.com/international-catalog or contact customer service at 800.433.7642.

DX – 30A

Hazardous Location Plugs & Receptacles

Devices & accessories rated for hazardous locations are not returnable.

Plug (male inlet w/handle)



Replace XXX or XX with suffix number to indicate desired cable range (see chart)

Inlet w/cap on box (male)



or

North American Configurations

Voltage	Polarity	Part # Metal
120V	1P+N+G	26-31165-XXX
125V	1P+N+G	26-31075-XXX
208V	2P+G	26-31162-XXX
208V	3P+G	26-31163-XXX
208V	3P+N+G	26-31167-XXX
250V	2P+G	26-31072-XXX
250V	3P+G	26-31073-XXX
250V	2P+N+G	26-31076-XXX
277V	1P+N+G	26-31045-XXX
480V	2P+G	26-31042-XXX
480V	3P+G	26-31043-XXX
480V	3P+N+G	26-31047-XXX
600V	3P+G	26-31143-XXX

Voltage	Polarity	Part # Metal
120V	1P+N+G	26-36165-XX
125V	1P+N+G	26-36075-XX
208V	2P+G	26-36162-XX
208V	3P+G	26-36163-XX
208V	3P+N+G	26-36167-XX
250V	2P+G	26-36072-XX
250V	3P+G	26-36073-XX
250V	2P+N+G	26-36076-XX
277V	1P+N+G	26-36045-XX
480V	2P+G	26-36042-XX
480V	3P+G	26-36043-XX
480V	3P+N+G	26-36047-XX
600V	3P+G	26-36143-XX

For international configurations (IEC/CE) visit meltric.com/international-catalog or contact customer service at 800.433.7642.

Ratings

- **Max Amperage & Voltage**
30A, 600 VAC
- **Environmental Ratings**
IP65
- **Temperature Range**
Min -13°F/Max 140°F
- **Wiring Capacity**
Min 14 AWG Max 8 AWG
* Based on THHN wire sizes
- **Applicable Standards**
ATEX, IECEx
- **Hazardous Location Ratings**

MARECHAL ELECTRIC MAROMME
© IIE2 G/D Ex de IIC tD A21
-25°C ≤ Ta ≤ +60°C T5 T84°C
-25°C ≤ Ta ≤ +50°C T6 T74°C
IECEX LCI 09.0014/LCIE 05 ATEX 6127

XXX Suffix / Cable Range

XXX (Suffix #)	Cable Range
-25M	.35" - .63"
-32M	.47" - .83"

Connector (female recept w/handle)



Receptacle on box (female)



Receptacle (female)



or

or

North American Configurations

Voltage	Polarity	Part # Metal
120V	1P+N+G	26-33165-XXX
125V	1P+N+G	26-33075-XXX
208V	2P+G	26-33162-XXX
208V	3P+G	26-33163-XXX
208V	3P+N+G	26-33167-XXX
250V	2P+G	26-33072-XXX
250V	3P+G	26-33073-XXX
250V	2P+N+G	26-33076-XXX
277V	1P+N+G	26-33045-XXX
480V	2P+G	26-33042-XXX
480V	3P+G	26-33043-XXX
480V	3P+N+G	26-33047-XXX
600V	3P+G	26-33143-XXX

Part # Metal	Part # Metal	Part # Metal
26-30165-XX	26-34165	
26-30075-XX	26-34075	
26-30162-XX	26-34162	
26-30163-XX	26-34163	
26-30167-XX	26-34167	
26-30072-XX	26-34072	
26-30073-XX	26-34073	
26-30076-XX	26-34076	
26-30045-XX	26-34045	
26-30042-XX	26-34042	
26-30043-XX	26-34043	
26-30047-XX	26-34047	
26-30143-XX	26-34143	



For international configurations (IEC/CE) visit meltric.com/international-catalog or contact customer service at 800.433.7642.

XX Suffix / NPT Size

NPT Thread Size	XX (Suffix #)
1/2"	-12
3/4"	-34
1"	-1

NPT sizes are determined by the cable diameter and third party cord grip.

Accessories

	Protective Cap
For Male Devices Only	Part #
DX30	26-3A126
	Metal Wall Box
NPT	Part #
1/2"	26-3A023-12
3/4"	26-3A023-34
1"	26-3A023-1

HAZARDOUS LOCATION

DX60



DX - 60A

Hazardous Location Plugs & Receptacles

Devices & accessories rated for hazardous locations are not returnable.

Ratings

- **Max Amperage & Voltage**
60A, 600 VAC
- **Environmental Ratings**
IP65
- **Temperature Range**
Min -40°F / Max 140°F
- **Wiring Capacity**
Min 6 AWG Max 1/0 AWG
* Based on THHN wire sizes
- **Applicable Standards**
ATEX, IECEx
- **Hazardous Location Ratings**

MARECHAL ELECTRIC MAROMME
 Ⓢ II2 G/D Ex de IIC tD A21
 -40°C ≤ Ta ≤ +60°C T5 T90°C
 -40°C ≤ Ta ≤ +50°C T6 T80°C
 IECEx LCI 09.0015/LCIE 04 ATEX 6038

Plug (male inlet w/handle)

Replace XXX or XX with suffix number to indicate desired cable range (see chart)



or



Inlet w/cap on box (male)

North American Configurations

Voltage	Polarity	Part # Metal
120V	1P+N+G	26-61165-XXX
125V	1P+N+G	26-61075-XXX
208V	2P+G	26-61162-XXX
208V	3P+G	26-61163-XXX
208V	3P+N+G	26-61167-XXX
250V	2P+G	26-61072-XXX
250V	3P+G	26-61073-XXX
250V	2P+N+G	26-61076-XXX
277V	1P+N+G	26-61045-XXX
480V	2P+G	26-61042-XXX
480V	3P+G	26-61043-XXX
480V	3P+N+G	26-61047-XXX
600V	3P+G	26-61143-XXX

Voltage	Polarity	Part # Metal
120V	1P+N+G	26-66165-XX
125V	1P+N+G	26-66075-XX
208V	2P+G	26-66162-XX
208V	3P+G	26-66163-XX
208V	3P+N+G	26-66167-XX
250V	2P+G	26-66072-XX
250V	3P+G	26-66073-XX
250V	2P+N+G	26-66076-XX
277V	1P+N+G	26-66045-XX
480V	2P+G	26-66042-XX
480V	3P+G	26-66043-XX
480V	3P+N+G	26-66047-XX
600V	3P+G	26-66143-XX

For international configurations (IEC/CE) visit meltric.com/international-catalog or contact customer service at 800.433.7642.

XXX Suffix / Cable Range

XXX (Suffix #)	Cable Range
-32M	.47" - .83"
-40M	.63" - 1.06"

XX Suffix / NPT Size

NPT Thread Size	XX (Suffix #)
1"	-1
1 1/4"	-114
1 1/2"	-112
2"	-2

NPT sizes are determined by the cable diameter and third party cord grip.

Connector

(female recept w/handle)



or

Receptacle on box

(female)



or

Receptacle

(female)



North American Configurations

Voltage	Polarity	Part # Metal
120V	1P+N+G	26-63165-XXX
125V	1P+N+G	26-63075-XXX
208V	2P+G	26-63162-XXX
208V	3P+G	26-63163-XXX
208V	3P+N+G	26-63167-XXX
250V	2P+G	26-63072-XXX
250V	3P+G	26-63073-XXX
250V	2P+N+G	26-63076-XXX
277V	1P+N+G	26-63045-XXX
480V	2P+G	26-63042-XXX
480V	3P+G	26-63043-XXX
480V	3P+N+G	26-63047-XXX
600V	3P+G	26-63143-XXX

Part # Metal	Part # Metal
26-60165-XX	26-64165
26-60075-XX	26-64075
26-60162-XX	26-64162
26-60163-XX	26-64163
26-60167-XX	26-64167
26-60072-XX	26-64072
26-60073-XX	26-64073
26-60076-XX	26-64076
26-60045-XX	26-64045
26-60042-XX	26-64042
26-60043-XX	26-64043
26-60047-XX	26-64047
26-60143-XX	26-64143

For international configurations (IEC/CE) visit meltric.com/international-catalog or contact customer service at 800.433.7642.

Accessories



Protective Cap

For Male Devices Only

Part #

DX60 26-6A126



Metal Wall Box

NPT

Part #

1" 26-6A023-1
 1 1/4" 26-6A023-114
 1 1/2" 26-6A023-112
 2" 26-6A023-2

DX - 100A

Hazardous Location Plugs & Receptacles

Devices & accessories rated for hazardous locations are not returnable.

Plug (male inlet w/handle)



Replace XXX or XX with suffix number to indicate desired cable range (see chart)

Inlet w/cap on box (male)



North American Configurations

Voltage	Polarity	Part # Metal
120V	1P+N+G	26-91165-XXX
125V	1P+N+G	26-91075-XXX
208V	2P+G	26-91162-XXX
208V	3P+G	26-91163-XXX
208V	3P+N+G	26-91167-XXX
250V	2P+G	26-91072-XXX
250V	3P+G	26-91073-XXX
250V	2P+N+G	26-91076-XXX
277V	1P+N+G	26-91045-XXX
480V	2P+G	26-91042-XXX
480V	3P+G	26-91043-XXX
480V	3P+N+G	26-91047-XXX
600V	3P+G	26-91143-XXX

Voltage	Polarity	Part # Metal
120V	1P+N+G	26-96165-XX
125V	1P+N+G	26-96075-XX
208V	2P+G	26-96162-XX
208V	3P+G	26-96163-XX
208V	3P+N+G	26-96167-XX
250V	2P+G	26-96072-XX
250V	3P+G	26-96073-XX
250V	2P+N+G	26-96076-XX
277V	1P+N+G	26-96045-XX
480V	2P+G	26-96042-XX
480V	3P+G	26-96043-XX
480V	3P+N+G	26-96047-XX
600V	3P+G	26-96143-XX

For international configurations (IEC/CE) visit meltric.com/international-catalog or contact customer service at 800.433.7642.

Connector (female recept w/handle)



Receptacle on box (female)



Receptacle (female)



North American Configurations

Voltage	Polarity	Part # Metal
120V	1P+N+G	26-93165-XXX
125V	1P+N+G	26-93075-XXX
208V	2P+G	26-93162-XXX
208V	3P+G	26-93163-XXX
208V	3P+N+G	26-93167-XXX
250V	2P+G	26-93072-XXX
250V	3P+G	26-93073-XXX
250V	2P+N+G	26-93076-XXX
277V	1P+N+G	26-93045-XXX
480V	2P+G	26-93042-XXX
480V	3P+G	26-93043-XXX
480V	3P+N+G	26-93047-XXX
600V	3P+G	26-93143-XXX

Part # Metal	Part # Metal	Part # Metal
26-90165-XX	26-90075-XX	26-94165
26-90075-XX	26-90162-XX	26-94075
26-90162-XX	26-90163-XX	26-94162
26-90163-XX	26-90167-XX	26-94163
26-90167-XX	26-90072-XX	26-94167
26-90072-XX	26-90073-XX	26-94072
26-90073-XX	26-90076-XX	26-94073
26-90076-XX	26-90045-XX	26-94076
26-90045-XX	26-90042-XX	26-94045
26-90042-XX	26-90043-XX	26-94042
26-90043-XX	26-90047-XX	26-94043
26-90047-XX	26-90143-XX	26-94047
26-90143-XX		26-94143

For international configurations (IEC/CE) visit meltric.com/international-catalog or contact customer service at 800.433.7642.

Ratings

- **Max Amperage & Voltage**
100A, 600 VAC
- **Environmental Ratings**
IP65
- **Temperature Range**
Min -40°F / Max 140°F
- **Wiring Capacity**
Min 1/0 AWG Max 2/0 AWG
* Based on THHN wire sizes
- **Applicable Standards**
ATEX, IECEx
- **Hazardous Location Ratings**

MARECHAL ELECTRIC MAROMME
 Ex II 2 G/D Ex de IIC tD A21
 -40°C ≤ Ta ≤ +60°C T5 T90°C
 -40°C ≤ Ta ≤ +50°C T6 T80°C
 IECEx LCI 09.0015/LCIE 04 ATEX 6038

XXX Suffix / Cable Range

XXX (Suffix #)	Cable Range
-32M	.47" - .83"
-40M	.63" - 1.06"
-50M	.91" - 1.38"
-63M	1.42" - 1.89"

XX Suffix / NPT Size

NPT Thread Size	XX (Suffix #)
1"	-1
1 1/4"	-114
1 1/2"	-112
2"	-2

NPT sizes are determined by the cable diameter and third party cord grip.

Accessories



Protective Cap

For Male Devices Only

Part #

DX100 26-9A126



Metal Wall Box

NPT

Part #

1" 26-9A023-1
 1 1/4" 26-9A023-114
 1 1/2" 26-9A023-112
 2" 26-9A023-2

HAZARDOUS LOCATION

DX



Dimensions

Inlet – Provided in inches

Dimensions are for reference only and may change depending on accessories used. For precise dimensions contact MELTRIC Engineering.

plug

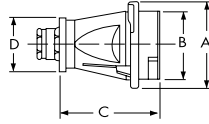

PRODUCT	A	B	C	D
DX20/DX30	4.06	3.19	4.65	2.68
DX60/DX100	5.75	4.65	8.66	3.94

Inlet + Connector

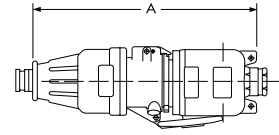

PRODUCT	A
DX20/DX30	15.94
DX60/DX100	24.88

Dimensions

Receptacle – Provided in inches

Dimensions are for reference only and may change depending on accessories used. For precise dimensions contact MELTRIC Engineering.

connector + plug

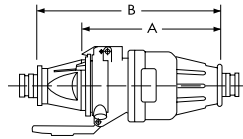

PRODUCT	A	B
DX20/DX30	9.65	12.68
DX60/DX100	16.06	21.14

receptacle + plug

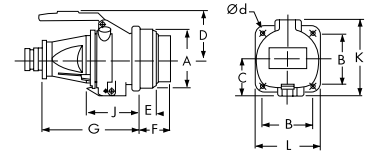

PRODUCT	A	B	C	D	E	F	G	J	K	L	Ød
DX20/DX30	4.09	3.62	2.60	3.35	1.14	2.17	6.77	3.74	5.39	4.61	0.26
DX60/DX100	5.83	4.80	3.62	4.33	1.06	3.54	11.89	6.81	7.28	6.30	0.35

receptacle/box + plug

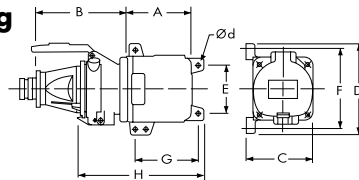

PRODUCT	A	B	C	D	E	F	G	H	Ød
DX20/DX30	4.76	6.77	4.76	6.57	3.54	5.71	4.69	9.45	.35
DX60/DX100	7.17	11.89	6.50	8.70	5.12	7.68	6.85	14.88	.39

MULTIPIN PXN12c

Product Features



Metal Casing

Provides excellent durability and protection.

IP65/IP66 Watertightness

Environmental rating is achieved as soon as the plug is latched to the receptacle. There is no additional rings to tighten.

Lid

Provides additional protection from harsh environments.

Recessed Contacts

Provides IP2X protection from live electrical parts.

Locking Provision

Turn triangular screw with special tool (provided) to prevent plug removal.

Spring Loaded Butt-Style Contacts

Ensures optimal contact force and superior electrical performance over thousands of operations.

Silver-Nickel Contacts

Silver-nickel contact material provides superior conductivity, durability and corrosion resistance.

Hazardous Duty Listings

ATEX

II 2 Ex e IIC Gb tb IIIC Db
 Suitable for Zone 1 & 2 (gas) 21 & 22 (dust)
 10A: -40 °C <Ta<+55 °C T5 T69 °C
 Ex ia or ib IIC Tb Gb
 IECEx LCIE 14.0041X/LCIE 07 ATEX 6070X



Highlighted Feature

- Crimped Contacts**
 PXN12c devices now feature contacts that can be crimped or soldered. Each device is supplied with 13 contacts so that the product can be set up to suit application needs.

Simple Assembly and Disassembly

DSN37c shown



Assembly

To insert contacts when they have been wired is simple. Push wired contact into rear of insulator until it stops to complete the installation.



Disassembly

To remove, use the tool provided. Push tool from front onto contact until tool stops. Contact is then released at rear of insulator.

PXN12c Multipin – 10A Hazardous Location Plugs & Receptacles

Devices & accessories rated for hazardous locations are not returnable.

Connector
(female receptacle w/handle)



Receptacle/Angle Receptacle/Angle/Box
(female)



Ratings

- **Voltage**
220 VAC or VDC
- **Amperage Ratings**
10A Not for disconnection of a live circuit
- **Environmental Ratings**
IP65/IP66
- **Temperature Range**
Min -40°F / Max 131°F
- **Wiring Capacity**
Min 16 AWG Max 14 AWG
* Based on THHN wiring connection type solder
- **Terminal Type**
Solder/Crimp
- **Applicable Standards**
ATEX, IECEx

North American Configurations

Voltage	Polarity	Cable Range	Part # Metal	Part # Metal	Part # Metal
220V	11P+G	[.35 - .63]	06-A3001-25M	06-A7001	06-A0001-25M
220V	11P+G	[.47 - .82]	06-A3001	06-A7001	06-A0001

For international configurations (IEC/CE) visit meltric.com/international-catalog or contact customer service at 800.433.7642.

Plug
(male inlet w/handle)



Inlet/Angle
(male)



Inlet/Angle/Box
(male)



North American Configurations

Voltage	Polarity	Cable Range	Part # Metal	Part # Metal	Part # Metal
220V	11P+G	[.35 - .63]	06-A1001-25M	06-A9001	06-A6001-25M
220V	11P+G	[.47 - .82]	06-A1001	06-A9001	06-A6001

For international configurations (IEC/CE) visit meltric.com/international-catalog or contact customer service at 800.433.7642.

Miscellaneous Accessories



Protective Cap	Multi-Contact Removal Tool	European Crimping Tool	Crimper Tool (Greenlee or equal)	Bag of 13 Female Contacts*	Bag of 13 Male Contacts*
06-2A126	9-LD12-37	61-CA500	4CN30	01-AA213	61-CA113

* Includes insulation sleeves and ferrules.

Dimensions Receptacle – Provided in inches

Dimensions are for reference only and may change depending on accessories used. For precise dimensions contact MELTRIC Engineering.

plug

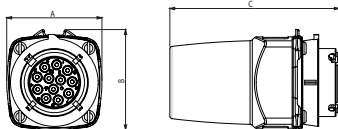

PRODUCT	A	B	C
PXN12c	2.28	2.40	4.09

receptacle / angle / junction box

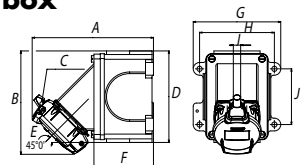

PRODUCT	A	B	C	D	E	F	G	H	I	J
PXN12c	5.98	5.12	4.53	2.95	4.33	3.70	.36	2.76		

MULTIPIN DXN25c/DXN37c

Product Features



Locking Provision

For insertion of locking pin (or padlock) to prevent inadvertent disconnection.

Metal Casing

Provides excellent durability and protection.

Lid

Provides additional protection from harsh environments.

Silver-Nickel Contacts

Silver-nickel contact material provides superior conductivity, durability and corrosion resistance.

Recessed Contacts

Provides IP2X protection from live electrical parts.

Spring Loaded Butt-Style Contacts

Ensures optimal contact force and superior electrical performance over thousands of operations.

IP66/IP67 Watertightness

Environmental rating is achieved as soon as the plug is latched to the receptacle. There is no additional ring to tighten.

Hazardous Duty Listings

ATEX

II 2 Ex e IIC Gb tb IIIC Db
Suitable for Zone 1 & 2 (gas) 21 & 22 (dust)
Ex ia or ib IIC T6 Gb

DXN25c -40°C ≤ Ta ≤ 60°C T5 T71°C
-40°C ≤ Ta ≤ 40°C T6 T51 °C

DXN37c -40°C ≤ Ta ≤ 55°C T5 T76°C
-40°C ≤ Ta ≤ 40°C T6 T56 °C



Highlighted Feature

- **Crimped Contacts**
DXN25c / DXN37c devices now feature contacts that can be crimped or soldered. Each device is supplied with 26 or 39 contacts so that the product can be set up to suit application needs.

Simple Assembly and Disassembly

DSN37c shown



Assembly

To insert contacts when they have been wired is simple. Push wired contact into rear of insulator until it stops to complete the installation.



Disassembly

To remove, use the tool provided. Push tool from front onto contact until tool stops. Contact is then released at rear of insulator.

DXN25c / DXN37c – 10A Hazardous Location Plugs & Receptacles

Devices & accessories rated for hazardous locations are not returnable.

Connector (female receptacle w/handle)



or

Receptacle/Angle (female)



or

Receptacle /Angle/Box (female)



North American Configurations

Voltage	Polarity	Cable Range	Part # Metal	Part # Metal	Part # Metal
440V	24P+G	(.50" - .825")	36-D3002-32M	36-D7002	36-D0002-32M
440V	24P+G	(.63" - 1.05")	36-D3002	36-D7002	36-D0002
230V	36P+G	(.50" - .825")	36-C3003-32M	36-C7003	36-C0003-32M
230V	36P+G	(.63" - 1.05")	36-C3003	36-C7003	36-C0003

For international configurations (IEC/CE) visit meltric.com/international-catalog or contact customer service at 800.433.7642.

Plug (male inlet w/handle)



or

Inlet/Angle (male)



or

Inlet/Angle/Box (male)



North American Configurations

Voltage	Polarity	Cable Range	Part # Metal	Part # Metal	Part # Metal
440V	24P+G	(.50" - .825")	36-D1002-32M	36-D9002	36-D6002-32M
440V	24P+G	(.63" - 1.05")	36-D1002	36-D9002	36-D6002
230V	36P+G	(.50" - .825")	36-C1003-32M	36-C9003	36-C6003-32M
230V	36P+G	(.63" - 1.05")	36-C1003	36-C9003	36-C6003

For international configurations (IEC/CE) visit meltric.com/international-catalog or contact customer service at 800.433.7642.

Ratings

- Voltage**
440 VAC or VDC DXN25c
230 VAC or VDC DXN37c
- Amperage Ratings**
10A DXN25c Not for disconnection of a live circuit
10A DXN37c Not for disconnection of a live circuit
- Environmental Ratings**
IP66/IP67
- Temperature Range**
Min -40°F/Max 140°F – (DXN25c)
Min -40°F/Max 131°F – (DXN37c)
- Wiring Capacity**
Min 16 AWG Max 14 AWG
* Based on THHN wiring connection type solder
- Terminal Type**
DXN25c: Solder/Crimp
DXN37c: Solder/Crimp
- Applicable Standards**
ATEX, IECEx

Accessories

Mult-Contact Removal Tool

Part # 9-LD12-37

European Crimping Tool

Part # 61-CA500

Crimper Tool Greenlee or equal

Part # 4CN30

Spare Bag of 13 Female Contacts*

Part # 01-AA213

Spare Bag of 13 Male Contacts*

Part # 61-CA113

* Includes insulation sleeves and ferrules.

Dimensions Receptacle – Provided in inches

Dimensions are for reference only and may change depending on accessories used. For precise dimensions contact MELTRIC Engineering.

connector

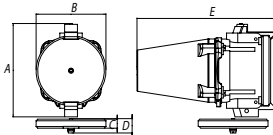

PRODUCT	A	B	C	D	E
DXN25c/37c	4.49	3.35	.43	.71	6.57

plug

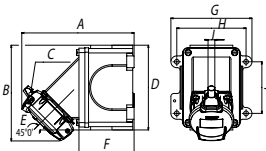

PRODUCT	A	B	C
DXN25c/37c	3.43	3.19	5.83

receptacle/angle/junction box

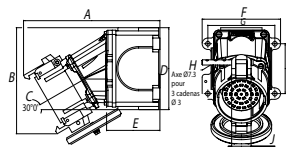

PRODUCT	A	B	C	D	E	F	G	H	I	J
DXN25c/37c	7.52	5.87	4.53	2.95	4.33	3.7	2.76	1.06		

Product Features



Hazardous Duty Listings

CSA	ATEX
Class I, Division 2, Group ABCD	⊕ II 2 G D Ex e IIC T* Gb Ex tIIIC T* Db IP65/IP66
Class II, Division 1 Groups EFG; Class III, Division 1	Suitable for Zone 1 & 2 (gas) 21 & 22 (dust)
Ex e IIC; Ex tb IIIC T56°C or T76°: IP66 (For Canada)	-20°C ≤ Ta ≤ 40°C T5 T56°C
Class I, Zone 1, AEx e IIC T5 or T6	-20°C ≤ Ta ≤ 60°C T5 T76°C
AEx tb IIIC T56°C or T76°C	-20°C ≤ Ta ≤ 40°C T6 T56°C
IP65/IP66 (For US)	-20°C ≤ Ta ≤ +60°C T4 T79°C



Amperage Ratings by Cable Size and ATEX Rating

	-20°C ≤ Ta ≤ 40°C G/D T5/T56°C	-20°C ≤ Ta ≤ 40°C G/D T6/T56°C	-20°C ≤ Ta ≤ 60°C G/D T5/T76°C
70mm ²	290A	235A	235A
95mm ²	415A	335A	335A
120mm ²	456A	376A	376A
150mm ²	493A	415A	415A
185mm ²	530A	450A	450A
240mm ²	570A	497A	497A
300mm ²	620A	540A	540A
400mm ²	680A	600A	600A

SPeX

Hazardous Location Plugs & Receptacles

Devices & accessories rated for hazardous locations are not returnable.

Plug (male inlet w/handle)



Receptacle on Angle (female)



North American Configurations

Color Code	Polarity	Part # without lug (by cable diameter)				Color Code	Polarity	Part # without lug
		.70-.98 in	.94-1.33 in	1.33-1.65 in	1.57-1.89 in			
	L1	42-41001-32P	42-41001-40P	42-41001-50P	42-41001-63P		L1	42-47001
	L2	42-41002-32P	42-41002-40P	42-41002-50P	42-41002-63P		L2	42-47002
	L3	42-41003-32P	42-41003-40P	42-41003-50P	42-41003-63P		L3	42-47003
	NEUTRAL	42-4100N-32P	42-4100N-40P	42-4100N-50P	42-4100N-63P		NEUTRAL	42-4700N
	GROUND	42-4100T-32P	42-4100T-40P	42-4100T-50P	42-4100T-63P		GROUND	42-4700T
	POSITIVE	42-4100P-32P	42-4100P-40P	42-4100P-50P	42-4100P-63P		POSITIVE	42-4700P
	NEGATIVE	42-4100M-32P	42-4100M-40P	42-4100M-50P	42-4100M-63P		NEGATIVE	42-4700M

IEC/CE Configurations

Color Code	Polarity	Part # without lug (by cable diameter)				Color Code	Polarity	Part # without lug
		.70-.98 in	.94-1.33 in	1.33-1.65 in	1.57-1.89 in			
	L1	46-41001-32P	46-41001-40P	46-41001-50P	46-41001-63P		L1	42-47001
	L2	46-41002-32P	46-41002-40P	46-41002-50P	46-41002-63P		L2	42-47002
	L3	46-41003-32P	46-41003-40P	46-41003-50P	46-41003-63P		L3	42-47003
	NEUTRAL	46-4100N-32P	46-4100N-40P	46-4100N-50P	46-4100N-63P		NEUTRAL	42-4700N
	GROUND	46-4100T-32P	46-4100T-40P	46-4100T-50P	46-4100T-63P		GROUND	42-4700T
	POSITIVE	46-4100P-32P	46-4100P-40P	46-4100P-50P	46-4100P-63P		POSITIVE	42-4700P
	NEGATIVE	46-4100M-32P	46-4100M-40P	46-4100M-50P	46-4100M-63P		NEGATIVE	42-4700M

Ratings

- **Voltage**
1000 VAC
- **Amperage Ratings**
See table page 209
- **Environmental Ratings**
IP65/IP66
- **Temperature Range**
See table page 209
- **Wiring Capacity**
Min 2/0 AWG Max 750 MCM
Aux Contacts 12-14 AWG
See table page 209
- **Applicable Standards**
CSA C22.2 No. 182.1,
CSA 213-M1987, CSA 25-1966,
ATEX, IECEx

Crimping lug*



Flexible MCM+ Wire Size	Straight with Terminal	Straight Threaded**
1	45-4A50C	45-4A50D
2/0	45-4A70C	45-4A70D
3/0	45-4A95C	45-4A95D
250	45-4A12C	45-4A12D
300	45-4A15C	45-4A15D
350	45-4A18C	45-4A18D
450	45-4A24C	45-4A24D
600	45-4A30C	45-4A30D
777	45-4A40C	45-4A40D

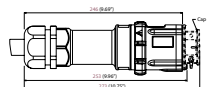

Dimensions
see page 142

* Use the straight threaded lug when cord mounting with handle accessory.

** Conductor sizes are approximations based on metric wire size conversions

+ Based on flexible type copper cables. See appropriate NEC tables for applicable ampacities.

Accessories & Options

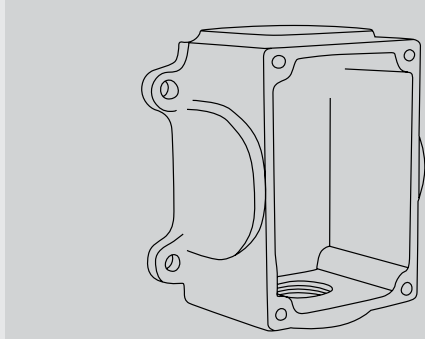
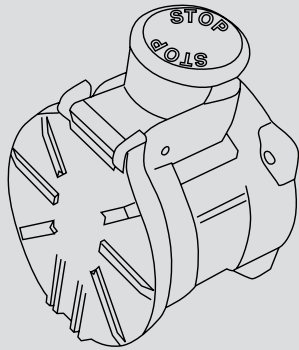
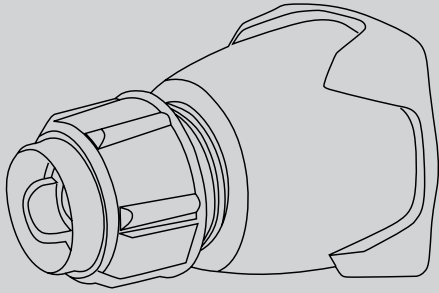

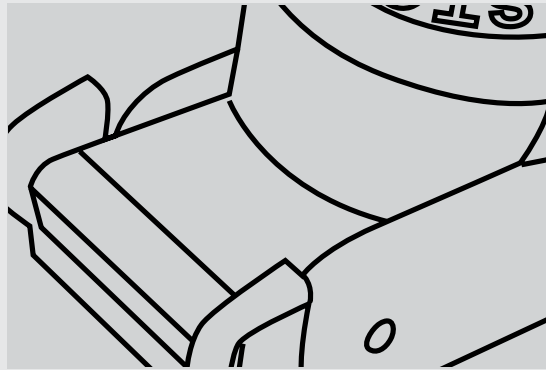

ACCESSORIES & OPTIONS

Auxiliary / Pilot Contacts	p. 213
Additional Watertightness	p. 214
Lid Configurations	p. 215
Plug Caps	p. 216
Pawl Options	p. 217
Auxiliary Switches	p. 218
Self-Ejecting Devices	p. 219

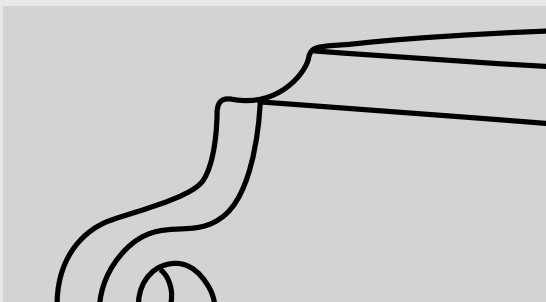
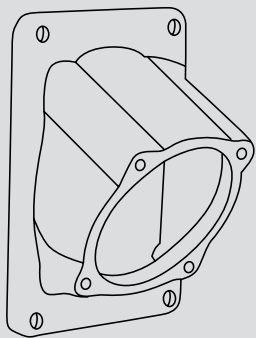

Auxiliary / Pilot Contacts

Auxiliary/pilot contacts can operate secondary circuits on the inlet or receptacle side of the circuit. They make last and break first when the plug is engaged or disengaged from the receptacle. To order a device with auxiliary/pilot contacts, add the appropriate suffix numbers listed to the right. Amperage ratings for the auxiliary/pilot contacts depend on the device size and operating voltage (see table below).

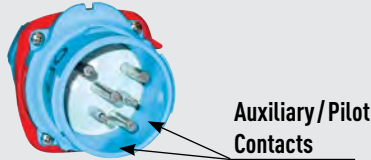

Decontactors with auxiliary/pilot contacts can make the operation of a facility safer and more efficient by facilitating the use of advanced control schemes. Decontactors with auxiliary/pilot contacts allow facilities to:

- ▶ **Quickly reconfigure or change-out processing equipment.**
The need for hard-wiring or multiple plug connections is eliminated.
- ▶ **Reduce equipment costs.**
The need for separate connections for the auxiliary/pilot contacts is eliminated.
- ▶ **Simplify the monitoring of key parameters.**
Thermistors on a motor driving a critical process pump can communicate temperature problems via auxiliary/pilot contacts in the Decontactor.
- ▶ **Communicate alarm signals or turn off equipment.**
When a motor is disconnected or unplugged, the auxiliary/pilot contacts can convey a signal that will de-energize the motor starter.

Auxiliary Contact Amperage Ratings

Product	120 VAC	240 VAC	480 VAC	600 VAC
DSN30, DSN60	6A	3A	1.5A	1.2A
DSN150	1.5A	0.75A	0.38A	0.3A
DS20, DS30, DS60, DS100C	6A	3A	1.5A	1.2A
DS100	3A	1.5A	0.75A	.6A
DS200	3A	1.5A	0.75A	-
DB30, DB60, DB100	6A	3A	1.5A	1.2A
DXN30, DXN60	5A*	5A*	5A	*5A (550V max)
PFQ300	7A	5A	2A*	2A*
PF (All sizes)	10A*	10A*	10A*	10A*
DR30, DR50, DR100	6A	3A	1.5A	1.2A
DR150, DR400	1.5A	0.75A	0.38A	0.3A
DR225, DR250	3A	1.5A	0.75A	.6A
SP	0.6A**	0.3A**	-	-
SPeX	-	6A(220V max)**	-	-
DS7c	-	-	5A(400V max)*	-
DR7c	-	5A*	-	-

* Rating is not UL or CSA listed

** Rating is not UL listed

Ordering Information

To order on a device, add the appropriate suffix to both the inlet and receptacle part numbers.

Product	2 Contacts	3 Contacts	4 Contacts	5 Contacts	6 Contacts
DSN30	-972	-	-	-	-
DSN60	-972	-973	-974	-	-
DSN150	-262	-263	-264	-975	-976
DS20	-972	-	-	-	-
DS30	-972	-973	-974	-	-
DS60/Poly	-972	-263	-	-	-
DS60/Metal	-972	-	-	-	-
DS100C/Poly	-972	-263	-	-	-
DS100C/Metal	-972	-	-	-	-
DS100	-262	-263	-264	-975	-976
DS200	-172	-173	-174	-175	-
DB30	-172	-	-	-	-
DB60	-172	-	-	-	-
DB100	-	-	-174	-	-
DXN30	-972	-	-	-	-
DXN60	-972	-	-	-	-
PFQ300	-	-	Standard (8)	-	-
PF300	-	-	Standard (4)	-	-
PF400	-	-	Standard (4)	-	-
PF600	-	-	Standard (4)	-	-
DR30	-972	-	-	-	-
DR50	-972	-973	-974	-	-
DR100/Poly	-972	-263	-	-	-
DR100/Metal	-972	-	-	-	-
DR150	-262	-263	-264	-975	-976
DR250	-172	-173	-174	-175	-
DS7c/DR7c	-172	-173	-	-	-
SP	Standard (2)	-	-	-	-

Replacement Auxiliary Contacts

Product	Male Pilot	Female Pilot
DSN30	61-3A011	61-3A021
DSN60	61-6A011-264	61-6A021-264
DSN150	61-9A011-219	61-9A229
DS20	31-1A011-30	31-1A021
DS30	61-6A011-262	61-6A021-262
DS60	31-6A011-172	31-6A229
DS100c	31-6A011-172	31-6A229
DR30	31-1A011-30	31-1A021
DR50	61-6A011-262	61-6A021-262
DR100	31-6A011-172	31-6A229
DR150	61-9A011-219	61-9A229

Additional Watertightness

For additional water protection when the inlet and receptacle are mated the following Type 4X option may be ordered for DS or DR models.



Type 4X Watertightness

Type 4X waterproofing is used for applications where connectors, plugs, and receptacles are subjected to water pressure. A gasket is added to the inlet and the receptacle lid is made to normally close.

Example:

To order on a device add suffix -4X to the inlet and receptacle part number.

DS20 Poly Inlet 2P + E = 33-18162-4X

To Order Gaskets Separately...

Model	Type 4X Watertightness
DS20	31-1A056
DS30	31-3A056
DS60	31-6A066
DS100C	31-6A066
DS200	39-2A056
.....	
DR30	31-1A056
DR50	31-3A056
DR100	31-6A066
DR250	39-2A056

Lid Configurations

There are four standard open lid configurations depending on the model and size of the device: 180° open, 120° open, 90° open and detached. Optionally, customers can order lids that are normally closed, or if the lid opens to 120° as standard, it can be ordered to open 180° for flush mounted inlets (DS & DR only).

Standard Lid Configurations

180° opening lids



Standard for:
 DSN20, DSN30, DSN60, DSN 150 poly
 DS20, DS30, DS60 Poly, DS100C poly, DS100 poly
 DR30, DR50, DR100 poly, DR150 poly
 DSDC1, DSDC3, DSDC6 poly, DSDC9 poly

120° Opening Lids



Standard for:
 DX20, DX30, DX60, DX100
 DXN20, DXN30, DXN60

90° Opening Lids



Standard for:
 DSN150 metal
 DS60 metal, DS100c metal, DS100 metal, DS200
 DR100 metal, DR150 metal, DR250, DR400
 DSDC6 metal, DSDC9 metal, DSDC2 metal
 DS60, DSN150 Hazardous Rated

Detached Lids

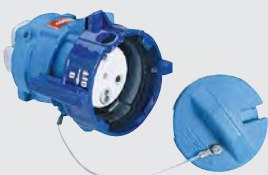

Standard for:
 DB30, DB60, DB100
 PFQ300, PF300, PF400, PF600
 SP
 DXA1
 DXN25c, DXN37c

Optional Lid Configurations

Closed Lid Configuration

Designed for female devices only. A normally closed lid configuration is available for applications where it is desirable to protect the receptacle face from dust, debris, or potential damage. This option provides a lid that will automatically close to a pre-latch position after removal of the plug. The lid must still be latched manually in order to achieve rated watertightness.



Lid



Available as option on:
 DSN (All sizes)
 DS (All sizes)
 DR (All sizes)
 DN (All sizes, except DN7c)

Normally closed lid configuration is recommended for cord to cord applications to keep the lid tucked in and avoid damage.

Examples:

To order a DSN, DS, DR, or DN device with a closed lid add **-NC** to the receptacle part number.

DS20 Poly receptacle 2P+G = 33-14162-NC

To order a DXN device with a closed lid add **-R** to the receptacle part number.

DXN receptacle 2P+G = 22-14162-R

180° Open Lid for Flush Mounted Inlets (DS, DR & DXN devices only)

When ordering an inlet that will be mounted directly flush against a wall or surface without an angle or box, the connector (receptacle + handle) may require the lid to be set for 180° opening.



Available as option on:
 DSN 150 metal
 DS100 metal, DS200
 DR150 metal, DR250
 DXN20, DXN30, DXN60

Example:

To order this configuration add suffix **-180** to the receptacle part number.

DS100 Metal Receptacle 3P+N+G = 37-94047-180

Plug Caps

Protective Neoprene Plug Caps

Neoprene caps provide an extra level of protection from dust, dirt, and rough handling for male plugs.

Watertight

Non-Watertight*



Typical for DSN, DS20, DS30, DS60, DS100c, DR30, DR50, DR100, DXN

Typical for DS100, DS200, DR150, DR250

Typical for DB and DN devices

Typical for PN devices

Ordering Information

Model	Neoprene Plug Cap
DSN20	61-1A426
DSN30	61-3A426
DSN60	61-6A426
DSN150	31-9A126
DS20	31-1A426
DS30	31-3A426
DS60	31-6A426
DS100C	31-6A426
DS100	31-9A126
DS200	31-2A126
DB30	89-3A126
DB60	89-6A126
DB100	89-9A126
DXN20	22-1A426
DXN30	22-3A426
DXN60	22-6A426
DR30	31-1A426
DR50	31-3A426
DR100	31-6A426
DR150	31-9A126
DR250	31-2A126
DN9c	DN16R
DN20c	DN63R
DN7c (90A)	DN63R
DN7c (150A)	31-2A126
PN20	01-2A126

Padlockable Plug Caps

Padlockable caps can be locked in place to prevent unwanted removal.



Typical for: DSN20, DSN30, DSN60, DS20, DS30, DS60, DS100C, DR30, DR50

Typical for: DS60, DS100C, DS100, DS200, DSN150, DR100, DR150, DR250

Ordering Information

Model	Padlockable Plug Cap
DSN20	61-1A826*
DSN30	61-3A826*
DSN60	61-6A826*
DSN150	DS9MC (Alum)
DS20	DS1PC (poly)
DS30	DS3PC (poly)
DS60	DS6MC (Alum)/DS6PC (Poly)
DS100C	DS6MC (Alum)/DS6PC (Poly)
DS100	DS9MC (Alum)
DS200	DS2MC (Alum)
DB30	-
DB60	-
DB100	-
DXN20	-
DXN30	-
DXN60	-
DR30	DS1PC (poly)
DR50	DS3PC (poly)
DR100	DS6MC (Alum)/DS6PC (Poly)
DR150	DS9MC (Alum)
DR250	DS2MC (Alum)

* Maintains IP66/IP67 and Type 4X protection

Notes: A 5/16" diameter lock/pin is needed for proper operation. Do not substitute a smaller diameter lock/pin.



* The lockout hole is not completely sealed off by the neoprene caps or the DS_PC and DS_MC caps. If environmental protection is needed while the plug is disconnected, the inlet should be ordered without the standard hole.

Example:

To order an inlet without a lockout hole add suffix **-A155** to the inlet part number.

DS20 Poly inlet 2P+G= 33-18162-**A155**

Pawl Options

Mushroom Pawl

The mushroom pawl is available as an alternative to the standard pawl. It is ideal for a quick disconnection of motors and other equipment, or in areas where employees use gloves and it is difficult to operate the standard pawls. The button has a red “stop” label for easy recognition.

Example:
To order on a receptacle add suffix **-375** to the receptacle part number.

DSN20 poly receptacle 2P+G=63-14162-375

Locking Mushroom Pawl

Locking mushroom pawls are available that include a screw which can be tightened to “lock” the pawl in place thus preventing release of the plug or the lid.

Example:
To order on a receptacle add suffix **-845** to the receptacle part number.

DS30 poly receptacle 3P+G =33-34163-845

Padlockable Mushroom Pawl

A padlockable mushroom pawl can be provided with a .32” hole that enables the lid to be locked closed, prohibiting access to the receptacle. Lockout Pin sold separately.

Example:
To order on a receptacle add **-375-843** to the receptacle part number.
To order a lockout pin order part **LP-843**.
DS30 poly receptacle 3P+G = 33-38043-375-843

Padlockable Standard Pawl

Standard pawls can be provided with a .32” hole that allows the lid of the receptacle to be locked closed or alternatively the plug can be locked in the connected position. Lockout Pin sold separately.

Example:
To order on a receptacle add suffix **-843** to the receptacle part number.
To order a lockout pin order part **LP-843**.
DSN20 poly receptacle 2P+G = 63-14162-843

Metal Pawl

Metal pawls are standard with metal receptacles only. If you prefer a metal pawl on a poly receptacle, add suffix **-824** to the poly receptacle part number. Available on DSN, DS and DR devices only.

Example:
DS60 poly receptacle 3P+G=33-64163-824

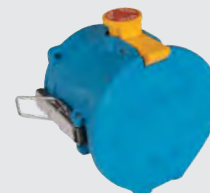

Available on:
DSN, DS, DR and DN devices only



Available on:
DSN, DS, DR and DN devices only



Available on:
DSN, DS, DR and DN devices only

Notes: A 5/16” diameter lock or lockout pin is needed for proper operation. Do not substitute a smaller diameter lock/pin.



Available on:
DSN, DS, DR and DN devices only

Notes: A 5/16” diameter lock or lockout pin is needed for proper operation. Do not substitute a smaller diameter lock/pin.



Available on:
DSN, DS and DR devices only

Auxiliary Switches

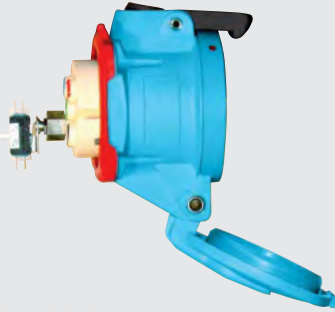

Female receptacles/connectors with up to 3 poles/4 wires are available with an optional auxiliary switch for operating secondary circuits on the line side of the circuit. The auxiliary switch is rated at 5A and includes one set of NO and one set of NC contacts. With the three phase devices the neutral contact of the plug operates the switch which is located in the neutral contact position in the receptacle. With the single phase units the third phase contact on the plug operates the switch which is located in the third phase contact position in the receptacle.

Auxiliary switches are available on:

DSN Series – DSN30, DSN60, and DSN150 only

DS Series – All Sizes

DR Series – All Sizes

Examples:

Order a receptacle with an auxiliary switch by adding suffix **-270** to the receptacle part number.

DSN30 Poly Receptacle 3P+G = 63-34043-270

*If the receptacle is 3 pole/4 wire, the mating plug must be ordered as a 4 pole/5 plus the suffix **-NNF** should be added.*

*DSN30 Poly Inlet 3P+N+G = 63-38047-**NNF***

*If the receptacle is 2 pole/4 wire (with neutral) the mating plug must be ordered as a 4 pole/5 wire and the suffix **-3NF** must be added.*

*DSN30 Poly Inlet 2P+N+G =63-38076-**3NF***

Notes: Devices ordered with auxiliary switch option are not UL/CSA listed.

Self-Ejecting Devices

General

Self-ejecting devices protect equipment from damage caused when mobile equipment is accidentally moved without disconnecting power. Self-ejecting systems are designed to automatically release the plug or connector when tension is detected by a tension cord attached between the pawl and the power cable.

Applications

Self-ejecting devices are commonly used on truck hook-ups, cranes, railroad cars, refrigerated food carts, delivery vehicles and other portable equipment.



Operation

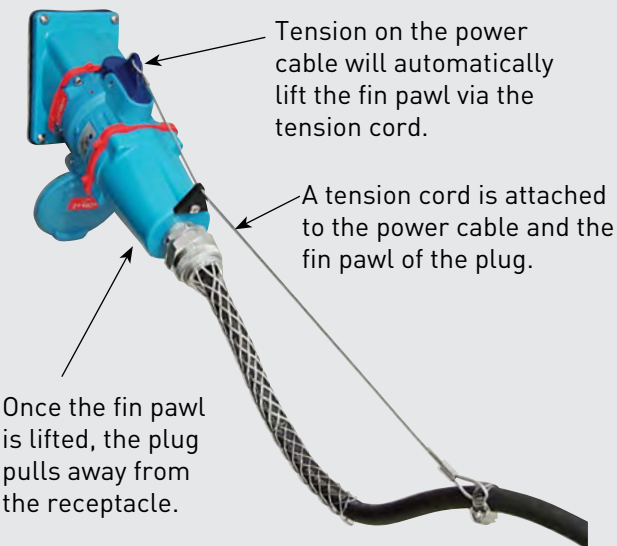

Self-Ejecting Female Connector/Receptacle



For self-ejecting female connectors, the standard pawl on the connector is replaced by a “shark’s fin” pawl that is attached to the power cable via a tension cord. If the connected equipment is moved, the tension cord lifts the shark’s fin pawl and the connector is released before damage can occur.

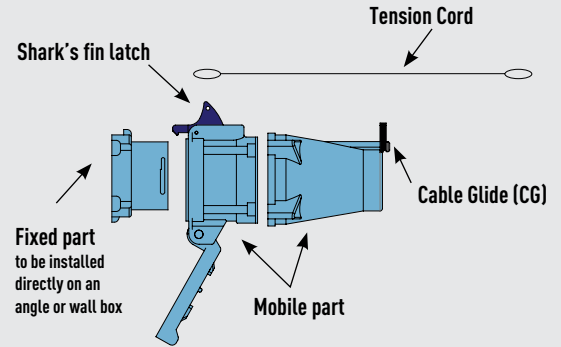

Available on:

DSN (All sizes)

DS (All sizes, except DS200)

DR (All sizes, except DR250)

How To Order:

To the female receptacle, add suffix **-354**
To the handle part number, add suffix **-CG**

Example:

To order a DSN30 with a nylon handle and metal angle, the part numbers would be:

Receptacle: 63-34043-354

Handle: 61-3A013-34-CG

Notes: Self-ejecting devices are modified to allow straight insertion. This defeats the safety shutter and voids the device's switch-rating.

Self-Ejecting Plug



For self-ejecting plugs, a shark's fin mechanism is added to the assembly and attached to the power cable via a tension cord. When tension is applied to the power cable, the tension cord lifts the shark fin mechanism, which in turn lifts the standard pawl on the receptacle and releases the plug before damage can occur.

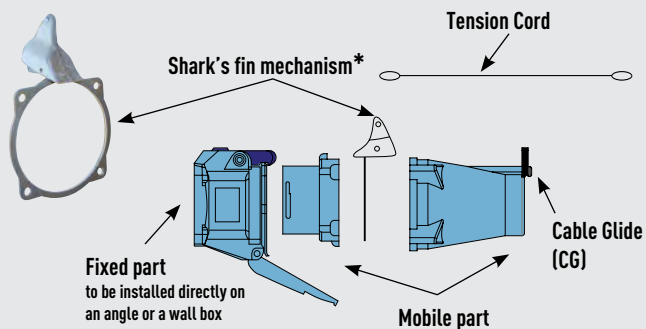

Available on:

DSN20, DSN30, DSN60

DR30, DR50, DR100

DS20, DS30, DS60

DSN24c, DSN37c, DS7, DR7

How To Order:

To the male inlet, add suffix **-338**

To the female receptacle, add suffix **-352**

To the handle part number, add suffix **-CG**

Example:

To order a DSN30 with a nylon handle and metal angle, the part numbers would be:

Inlet: 63-38043-**338**

Receptacle (straight Insertion): 63-34043-**352**

Handle: 61-3A013-34-**CG**

Notes: Self-ejecting devices are modified to allow straight insertion. This defeats the safety shutter and voids the device's switch-rating.

* A new shark's fin mechanism with similar functionality will be implemented in 2017. Contact Customer Service or visit meltric.com for updates.

Self-Ejecting Plug (DS100, DSN150, DS200, DR150, DN9c, DN20c only)



For self-ejecting plugs on DS100, DSN150, DS200, DR150, DN9c and DN20c models, a cam mechanism is used in lieu of the 'shark-fin mechanism'. The principle of operation remains the same.

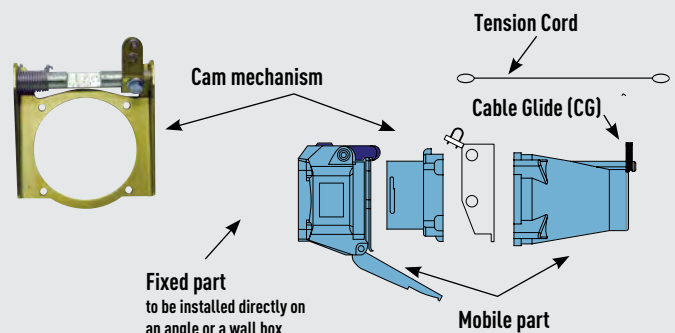

Available on:

DS100, DS200

DSN150

DR150

DN9c, DN20c

How To Order:*

To the male inlet, add suffix **-338**

To the female receptacle, add suffix **-352**

To the handle part number, add suffix **-CG**

Example:

To order a poly DS100 with a nylon handle and metal angle, the part numbers would be:

Inlet: 33-98043-**338**

Receptacle (straight Insertion): 33-94043-**352**

Handle: 9PH34-**CG**

* For DS200 ordering, use suffixes listed in DS200 section

Notes: Self-ejecting devices are modified to allow straight insertion. This defeats the safety shutter and voids the device's switch-rating.

Technical Manual

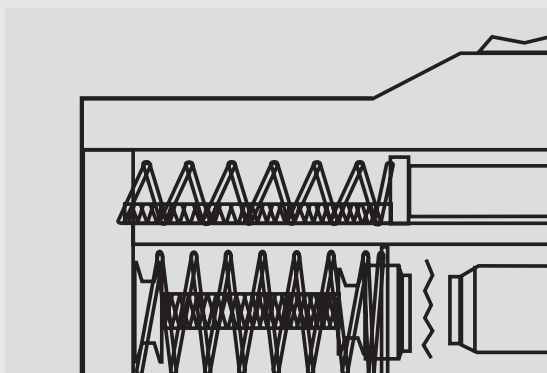
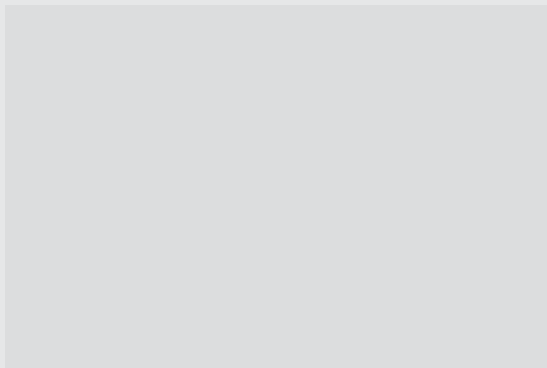
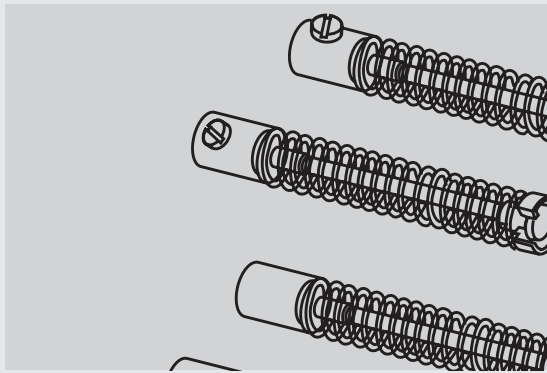
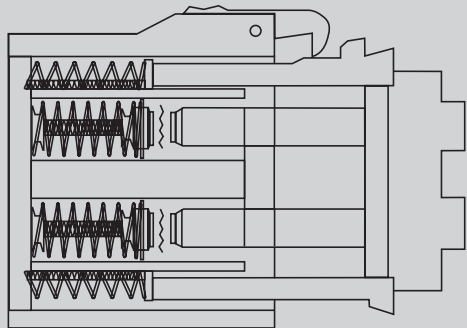

TYPE 4X

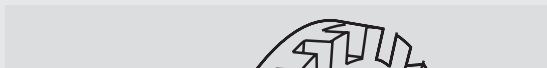

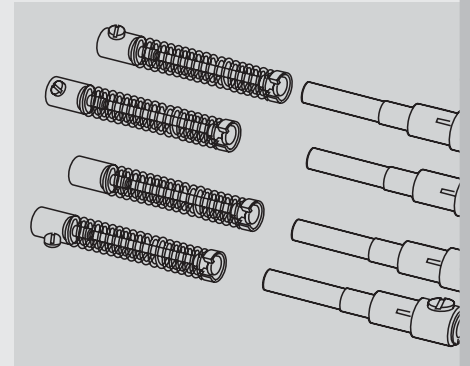

TECHNICAL MANUAL

Switch-Ratings vs Current Interrupting Ratings	p. 223
Electrical Performance	p. 224
Butt-Contact Technology	p. 227
Dead-Front Construction	p. 229
Keying System	p. 230
Dual Voltage Devices	p. 230
Resistance to Environments and Chemicals	p. 231
Watertightness/Ingress Protection	p. 233
Impact Resistance	p. 234
Operating Temperatures	p. 234
Color-Coded Gaskets & Labels	p. 235

Electrical Performance – Switch-Rated, Current Interrupting Rated and Non-Current Interrupting Rated Devices

Switch-Rated Plugs & Receptacles

MELTRIC’s DSN, DS & DB Series products are UL & CSA listed as switch-rated plugs and receptacles. These ratings allow them to be used as a motor circuit disconnect switch, as well as a branch circuit disconnect switch. Switch-rated plugs and receptacles have passed electrical overload, short circuit and endurance tests that are far more rigorous than those applied to other plugs and receptacles. These tests include the functional requirements for safety disconnect switches in addition to manual motor controllers. For more information about the tested electrical performance of switch-rated devices consult pages 223 - 226.

Current Interrupting Rated Plugs & Receptacles

Other MELTRIC devices such as the DXN plugs and receptacles are UL and/or CSA rated for “current interrupting”. A current interrupting rated plug and receptacle is not subjected to the same level of endurance testing as a switch-rated device and does not need to be subjected to any overload-locked rotor or short circuit testing (see pages 223 - 226 for performance test comparisons). Plug and receptacles rated for “current interrupting” are not intended to be used as switches, but can withstand making and breaking of normal resistive loads. Devices that are not hp and short circuit rated are not intended to make and break motor loads or other inductive loads.

Non-Current Interrupting Rated Plugs & Receptacles

Many competitive plugs and receptacles, as well as some MELTRIC devices are “non-current interrupting” rated. They are not approved by UL or CSA for connecting or disconnecting under load. They have passed the minimum test requirements for plugs and receptacles but they have not passed current interrupting performance tests or the more demanding electrical endurance, overload and short circuit tests required of switch-rated devices. For more information about the tested electrical performance of non-current interrupting rated devices consult pages 223 - 226.



Ratings	Product
Switch-Rated	DSN
	DS
	DB
Current Interrupting Rated	DXN
	DXA1
	Multipin
	DR
	PN
	DX
	Competitors Pin and Sleeve
Non-Current Interrupting Rated	Multipin
	PF/PFQ
	DSDC
	SPeX
	DS60 DSN150 (Haz Loc) Competitors Pin and Sleeve

Note: DXN37c, PXN12c, and SPeX hazardous duty devices are not to be connected or disconnected while the circuit is energized.

Electrical Performance

Overload Conditions

UL & CSA standards for plugs and receptacles require that the devices be able to withstand overload conditions. General use conditions are simulated by testing a device to a specified number of operations (50) at 150% of rated current and a power factor between 0.75 and 0.80. Switch-rated plugs and receptacles that are horsepower rated must perform overload testing at 600% of full load motor current with a more severe power factor (between 0.40 and 0.50) to simulate locked rotor conditions.

UL & CSA Standards – Overload Test Requirements and Ratings Comparisons

Test	UL 1682 & CSA 22.2 No. 182.1		UL Subject 2682 (used for both UL & CSA listings)
	Plugs, Receptacles & Cable Connectors of the Pin & Sleeve Type		Switch-Rated Plugs & Receptacles
	Non-Current Interrupting (Typical)	Current Interrupting (Typical)	Motor / Branch Circuit Switch-Rated (Typical)
Overload (General Use Devices)	3 Operations @ 150% of Rated Current (p.f. = .75 - .80)	50 Operations @ 150% of Rated Current (p.f. = .75 - .80)	50 Operations @ 150% of Rated Current (p.f. = .75 - .80)
Overload - Locked Rotor (Horsepower Rated Devices)	-	-	50 Operations @ 600% of Full Load Motor Current (p.f. = .40 - .50)

- The overload requirement for testing DC devices is 1 operation.

Test Results: Completed Operations at Overload/Locked Rotor Condition

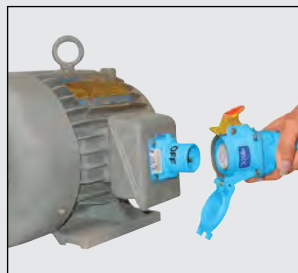
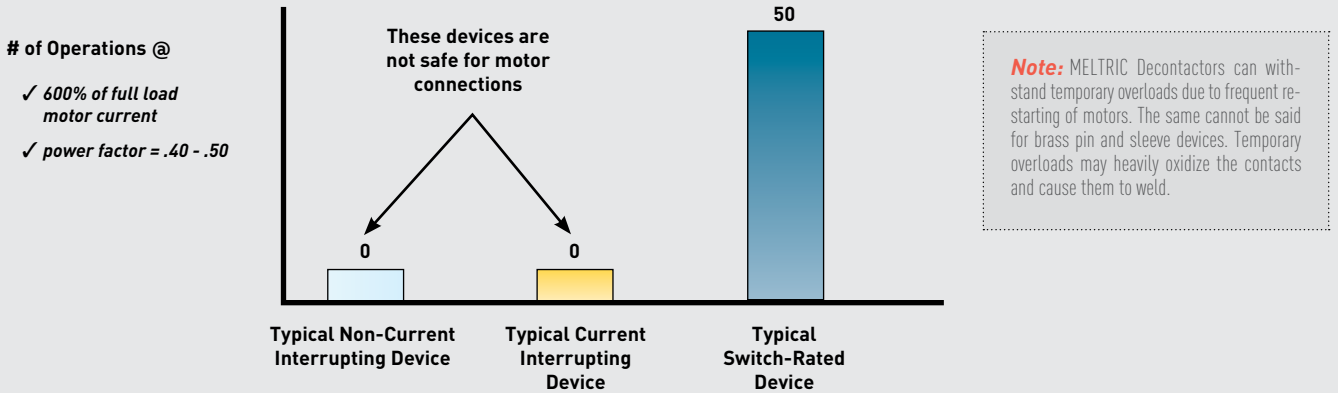

Motors and other equipment can be quickly and safely connected or disconnected with MELTRIC's Switch-Rated DECONNECTOR™ Series plug and receptacles.

Electrical Performance

Mechanical and Electrical Endurance

UL and CSA standards require endurance testing to ensure that rated performance is maintained over the expected life of the device. The severity of this testing depends on the rating of the device.

As shown in the chart below, non-current interrupting devices are tested only for mechanical endurance. Current interrupting devices are additionally subjected to moderate electrical endurance testing, and switch-rated devices are subjected to a much more severe level of electrical endurance testing, which is similar to that required of disconnect switches. In this regard, switch-rated devices may be required to make and break under full load more than 20 times as many operations (depending upon device amperage) as a current interrupting rated pin and sleeve device.

UL & CSA Standards – Endurance Test Requirements and Ratings Comparisons

Test	UL 1682 & CSA 22.2 No. 182.1		UL Subject 2682 (used for both UL & CSA listings)
	Plugs, Receptacles & Cable Connectors of the Pin & Sleeve Type		Switch-Rated Plugs & Receptacles
	Non-Current Interrupting	Current Interrupting	Motor / Branch Circuit Switch-Rated
Mechanical Endurance (no load)	15-20A = 5000 Operations 21-63A = 2000 Operations 64-250A = 250 Operations	15-20A = 0 Operations 21-63A = 1000 Operations 64-250A = 500 Operations	6000 Operations (Covered by Electrical Endurance testing)
Electrical Endurance (With Load)	-	15-20A = 5000 Operations 21-63A = 1000 Operations ¹ 64-250A = 250 Operations ¹ @ Rated Current & Voltage (p.f. = .75 - .80)	6000 Operations @ Rated Current & Voltage (p.f. = .75 - .80)

Notes: ¹ Testing alternates between mechanical & electrical operations. This reduces the severity of the electrical test by allowing additional cooling time during electrical testing.

Electrical Endurance Test Comparison

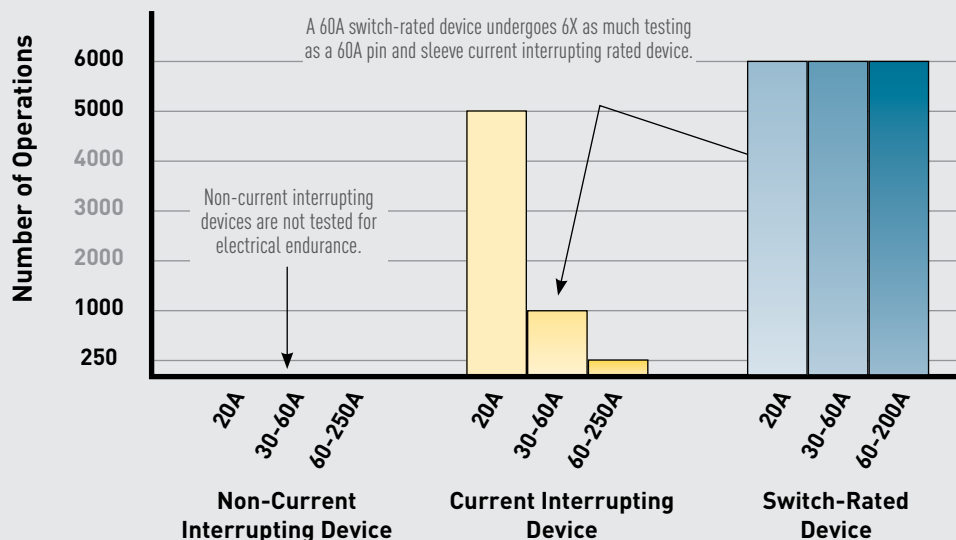

Electrical Performance

Short Circuit Protection

MELTRIC's DS, DSN, and DB products have successfully completed high fault current short circuit testing. All these devices have short circuit make (close) and withstand ratings of either 65 kA or 100 kA. UL witnessed and approved this testing.

UL Recognized Short Circuit Capabilities

UL Recognized Short Circuit Capabilities			
Plug & Receptacle Type	Short Circuit Ratings		Product Standard
	Withstand	Make	
General Use Pin & Sleeve Devices	None	None	UL 1682
HP Rated Twist-Type Devices	1kA	None	UL 498
Motor Rated Pin & Sleeve Devices	10kA	None	UL 1682
MELTRIC Switch-Rated Devices	≥ 65kA	≥ 65kA	UL Subject 2682

Short Circuit Test Information

Fusing – The amperage and time delay characteristics of the fusing used in testing affects the electrical load seen by the device. UL Subject 2682 requires short circuit tests be performed with fuses having an amperage rating that is no less than 400% of full load motor ampacity for horsepower rated devices, or no less than 100% of the device's amperage rating for general use devices.

MELTRIC used RK1 non-time delay type fusing for the horsepower rated devices because it is a common type of fuse used in motor applications. MELTRIC selected RK5 Time Delay fusing for the non-horsepower rated devices (DS9 & DS2) because it represents the most severe case of the various fusing scenarios that are typically used for general use applications.

Power Factor – The lower the power factor (p.f.) the more rigorous the test. UL Subject 2682 requires short circuit testing at 42,000 amps and above to be performed with a p.f. of 0.15 or less. By comparison, the p.f. for the 10,000 amp short circuit withstand test required by UL 1682 for horsepower rated plugs & receptacles, is a much less rigorous 0.50.

Short Circuit Test Summary Table

Device Information			Short Circuit Make & Withstand Rating ¹			
Model	General Use Rating	Max Motor FLA	kA	VAC	Fusing used in Testing	
DSN20	20A	8A (2 hp @ 208 VAC)	100	600	RK1	35A
DSN30	30A	17A (15 hp @ 600 VAC)	100	600	RK1	125A
DSN60	60A	27A (20 hp @ 480 VAC)	100	600	RK1	125A
DSN150	150A	96A (75 hp @ 480 VAC)	10	600	RK1	400A
	-	-	100	600	RK1	225A
DS20	20A	17A (5 hp @ 208 VAC)	100	600	RK1	80A
DS30	30A	21A (15 hp @ 480 VAC)	100	600	RK1	125A
DS60	60A	27A (25 hp @ 600 VAC)	100	600	RK1	250A
DS100C	100A	34A (25 hp @ 480 VAC)	100	600	RK1	250A
DS100	100A	40A (30 hp @ 480 VAC)	65	600	RK1	175A
	100A	-	65	600	RK5 TD	100A
DS200	200A	-	65	600	RK5 TD	200A
DB30	30A	27A (25 hp @ 600 VAC)	100	600	RK1	125A
DB60	60A	49A (15 hp @ 208 VAC)	100	600	RK1	250A
DB100	100A	92A (30 hp @ 208 VAC)	100*	600	RK1	250A

¹ Testing was performed with RK1 current limiting fuses sized at 400% of the highest full load motor ampacity associated with the device's hp rating. DS100 & 200 are rated 65kA.

* The fusing used limits the 100kA rating to 60hp @ 600V, 40hp @ 480V, 20hp @ 240V & 208V

Contact Technology

MELTRIC products feature silver-nickel, spring-loaded butt contacts similar to those used in motor starters and contactors.

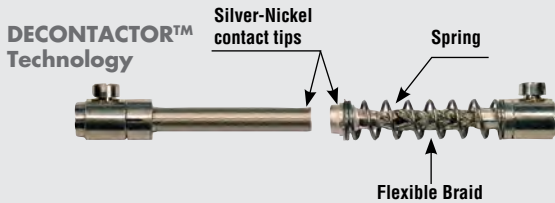

Silver-Nickel Contact Material

MELTRIC uses solid silver-nickel (85%/15%) contacts. The silver-nickel material has significant advantages over the brass contacts commonly used on competitive devices.

Silver has very low initial contact resistance and is not negatively affected by oxidation. This helps to give it excellent electrical properties that are maintained even at high temperatures and after tarnishing. Nickel is a much harder material and contributes excellent mechanical properties. The combination of silver and nickel results in a contact material that has both superior electrical capabilities and excellent resistance to wear. Silver-nickel only welds at extremely high pressure and temperature, and thus, also withstands arcs very well. These features make silver-nickel a commonly used contact material by switchgear manufacturers.

By contrast, the brass material used in most competitive plugs and receptacles has much higher initial contact resistance and is negatively affected by oxidation. In an oxidized state, the contact resistance of brass is more than 20 times higher than that of silver-nickel. In addition, brass is a soft material that wears rapidly. In use, brass pin and sleeve and arcuate contacts suffer from the combined effects of the limitations of the material and the design. As oxidation and wear induced reductions in contact force occur, contact resistance increases. This increases operating temperature, which causes further oxidation and wear, perpetuating a vicious cycle of degradation. Brass is not arc resistant and is not suitable for making and breaking under load.

MATERIAL	CONTACT	RESISTANCE
	NEW	OXIDIZED
SILVER	6 $\mu\Omega$	25 $\mu\Omega$
SILVER-NICKEL	23 $\mu\Omega$	60 $\mu\Omega$
COPPER	29 $\mu\Omega$	400 $\mu\Omega$
BRASS	370 $\mu\Omega$	1400 $\mu\Omega$

In an oxidized state, silver-nickel is 20 times more conductive than brass.

Spring-Loaded Contacts

Spring-loading of the contacts ensures that optimal pressure between the contacts is maintained – even after tens of thousands of operations. This point is important because contact force is a key determinant of the quality of the connection. As the accompanying graph demonstrates, contact resistance increases as contact force decreases. Higher contact resistance generates more heat and oxidation, both of which contribute to the deterioration of the contact. This is a problem with pin and sleeve and arcuate type contacts because their contact force varies with manufacturing tolerances and is reduced due to wear that occurs with normal use.

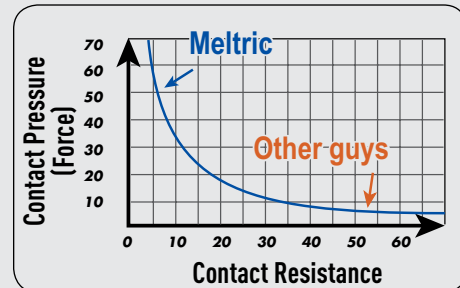

Higher contact pressure leads to lower contact resistance.

Butt-Style Connection

MELTRIC's butt-style contact configuration provides a positive and secure connection and also makes connection and disconnection easy. With butt contacts, the force applied to the contacts is in-line with the insertion motion, so inserting a plug into its socket requires only a known and limited amount of effort. Contact wear and sensitivity to manufacturing tolerances is negligible, because the spring-loading is sufficient to compensate for minor differences in contact length.

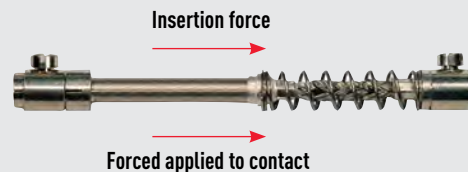

With MELTRIC's butt contacts the force applied to the contacts is in-line with the insertion motion.

With the pin and sleeve design used by our competitors, the contact force is at a right angle to the insertion/withdrawal force. There are numerous drawbacks to such a design:

- ▶ The contact pressure must be sufficient to prevent excessive temperature rise but is limited by the need to keep the insertion force reasonable.
- ▶ The necessary friction wears out the contacts, and diminishes contact pressure over time.
- ▶ Normal manufacturing tolerances result in wide variations in performance, even with new devices.
- ▶ The sliding contact design does not make & break cleanly, so arcing is more likely to occur.

Quick Break Mechanism

On most MELTRIC devices, the circuit is broken simply by depressing the pawl. Doing so releases the energy in a spring-loaded operating mechanism, which instantaneously breaks the circuit and ejects the plug to the 'OFF' position. Contact breaking time is about 15 milliseconds. The quick break mechanism is automatically reloaded when the plug is re-inserted.

DECONTACTOR™ Technology

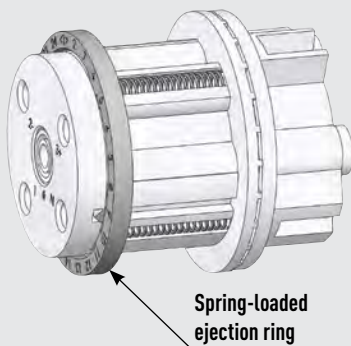

Spring-loaded ejection system ensures a quick break of the contacts.

In contrast, the disconnection speed of pin and sleeve and twist type devices is dependent on the users motion when removing the plug.

Self-Cleaning System

MELTRIC contacts close with a self-cleaning, wiping action. When the contacts initially mate, they are slightly offset. In completing the connection, the plug contacts are rotated partially across the receptacle contacts, helping to remove deposits from the contact surface.

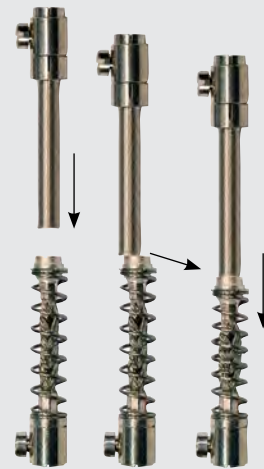

MELTRIC contacts are self cleaning.

Contact Mating Sequence

Decontactor contacts mate in a specific sequence to ensure a proper and safe connection.

1. The earth (ground) closes first
2. Then the neutral,
3. Then the phases,
4. Then the auxiliary contacts, if any. These auxiliary contacts can, therefore, be used as "pilot" contacts.

On opening, the sequence is reversed.

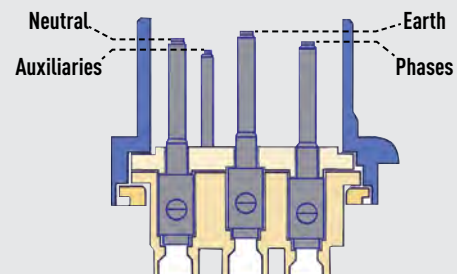

The contacts are set in the plug at different levels to achieve the desired mating sequence.

Dead Front and Enclosed Arc Chambers

For Maximum Protection from Live Parts

Most MELTRIC receptacles feature a dead front which encloses and isolates the live contacts when the plug is removed. Only electrically compatible plugs can unlock the safety shutter and gain access to the live parts. In addition to preventing accidental exposure to live parts, the safety shutter also keeps the contacts clean and out of reach even if the lid is left open.



The receptacle's dead front protects workers from accidental tool and wire insertion.

Protection During the Making and Breaking Process

When disconnecting or connecting a MELTRIC plug from/to a receptacle, the user is completely protected from exposure to arc flash or live parts. This is because the contacts can only make or break while they are enclosed in internal arc chambers within the receptacle.

During disconnection, the pressing of the pawl on the receptacle breaks the connection (inside the arc chambers) and ejects the plug to its rest or "OFF" position. While in the rest position, the plug and receptacle casings maintain a dead front and thus protect the user from live parts. The plug can not be fully withdrawn until it is rotated 30° counterclockwise. This closes and locks the safety shutter preventing access to live parts during and after the removal of the plug.

During connection, the plug contacts can only access the receptacle contacts after the plug has been partially inserted into the receptacle and has then been rotated 30° to open the safety shutter. Because the interaction of the skirted plug casing with the receptacle forms a protective enclosure that prevents access to the contacts as soon as insertion begins, a dead front is maintained even after the safety shutter is opened. Once the safety shutter has been opened, the plug contacts can be safely inserted into the arc chambers where the connection is made as the plug is latched to the receptacle.

DECONTACTOR™ Technology

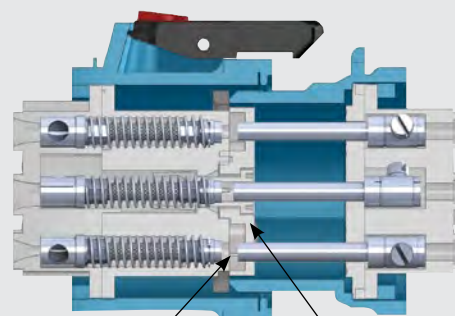

Arc chamber prevents outside exposure to arc flash.

Safety shutter prevents finger or tool access to live parts.

Protection from Insertion of Inappropriate Plugs

MELTRIC products offer up to 24 different keying positions. Only plugs and receptacles that are keyed/notched in the same positions will mate with each other. Non-compatible plugs will be unable to open the safety shutter. This system prevents potentially dangerous situations. For example, a 250VAC plug (notch 07) can not be inserted into a 480VAC receptacle (notch 04). Alternatively, on the PF and DX series, pegs and holes perform the same function as the notches.

Note: Some of the keying positions have been assigned to a designated global voltage. A few others are unassigned and are available if a user prefers to limit mating of plugs and receptacles that are only to be used on particular applications.

Commonly Used Keying Positions

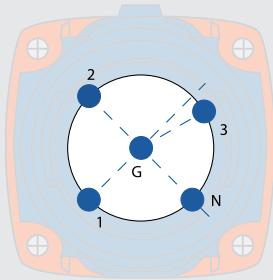

Position 04
255-277VAC/440-480VAC 60Hz

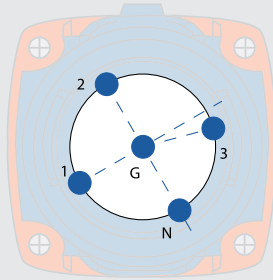

Position 07
110-125/220-250VAC 60Hz

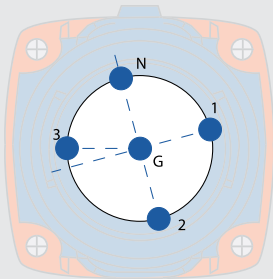

Position 14
347/600VAC 60Hz

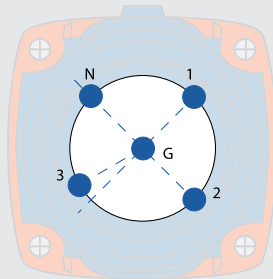

Position 16
120-127VAC/208-220VAC 60Hz

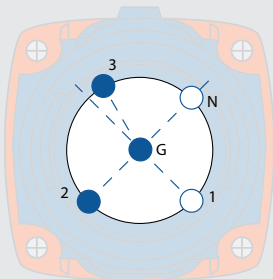

Position 10
110-130VDC

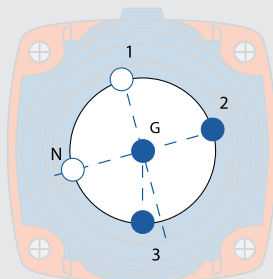

Position 20
220-250VDC

Note: See chart on page 15 for a complete list of voltage polarization positions and associated voltages.

How to Identify Keying Positions of an Existing Device

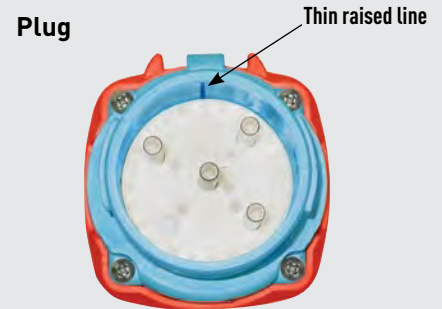

The keying position of most MELTRIC plugs can be determined by looking at the plug interior and finding a thin, raised line in the casing. This line is always directly above a number that identifies the plug's keying position.



The keying position for most receptacles can be determined by identifying a raised arrowhead (usually on the pawl or on the casing next to the pawl). This arrow points to a key number that can be found on the ring that surrounds the safety shutter.

Dual Voltages Devices Maximize User Flexibility

Some MELTRIC receptacles are designed to safely allow dual voltage capabilities.

For example, a 208V rated 3P+N+G receptacle will safely provide power to several configurations of 208V plugs and a single phase 120V plug. Having two voltages delivered by a single receptacle allows some facilities to significantly reduce the number of receptacles that need to be installed.

Dual voltage receptacles are supplied with dual color coded voltage stickers.

Dual Voltages Typically Available from MELTRIC

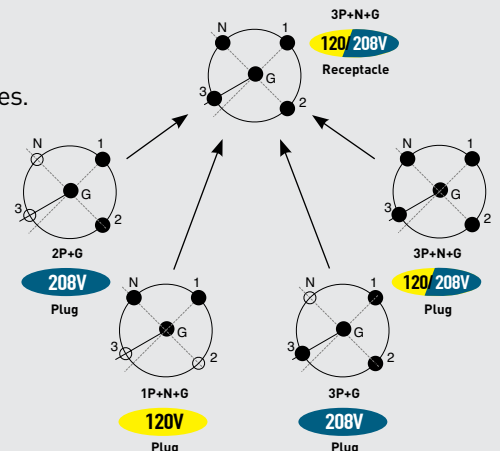
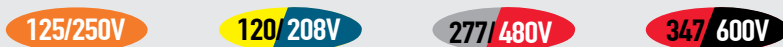

Device Materials and their Resistance to Environments and Chemicals

Polymeric Materials

Casings – The common technical name for the “Poly” material used by MELTRIC is PBT or PBTP (Polybutylene Teraphthalate). It consists of a special blend of thermoplastic polyester, fiberglass and elastomers which provides outstanding resistance to most chemical agents and environmental conditions, including UV and gamma rays. This material also offers high impact resistance across a broad spectrum of temperatures (shock resistance ratings to IK08).

Interiors – The arc chambers for most MELTRIC devices are made of Melamine or of a special compound of thermoplastic polyester, fiberglass, and elastomer. Other materials are used such as Polyamide and Bakelite.

Accessories – Handles, angles and wall boxes are made of Polyamide (they are supplied with self tapping screws).

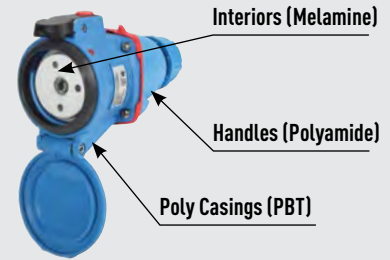

Products with Poly (PBT) casings

DSN20, DSN30, DSN60, DSN150

DS20, DS30, DS60, DS100, DS100C

DR30, DR50, DR100, DR150

DXN20, DXN30, DXN60

DSN24, DSN37, DS7, DR7

Resistance of Polymeric Casings to Various Chemical Agents * see note on following page

Agent	Polyester reinforced glass fiber			Polyamide		
	23°C	60°C	80°C	23°C	60°C	80°C
Butyl acetate	☆☆	☆☆		☆☆		
Ethyl acetate	☆			☆☆		
Acetone	☆			☆☆		
Acetic acid	5%	☆☆	☆☆	☆	☆	-
	10%	☆☆	☆	☆	-	-
Hydrochloric acid	10%	☆☆	☆☆	☆☆		
Chromic acid	40%	☆☆	☆☆	☆☆		
Citric acid	10%	☆☆	☆☆	☆☆		
Formic acid	5%	☆☆	☆	☆☆		
Nitric acid	10%	☆☆	☆	☆☆		
Oleic acid	100%	☆☆	☆☆	☆☆		
Phosphoric acid	3%	☆☆	☆☆	☆☆		
	30%	☆☆	☆☆	☆☆		
	85% (conc)	☆☆	☆☆	☆☆		
Sulphuric acid	3%	☆☆	☆☆	☆☆		
	30%	☆☆	☆☆	☆☆		
Ethyl alcohol		☆☆		☆☆		
Methyl alcohol		☆☆		☆☆		
Aniline		☆☆		-		
Benzene		☆	☆	☆☆		
Soda Bicarbonate	10%	☆☆	☆☆	-	☆☆	☆☆
Potassium bichromate	10%		☆☆		☆☆	
Sodium bisulphate	10%	☆☆	☆☆	-	☆☆	☆☆
Butane		☆☆		☆☆		
Butanol		☆☆		☆☆		
Soda carbonate	10%	☆☆	-	☆☆	☆☆	☆☆
	20%	☆☆	-	☆☆	☆☆	☆☆
Disulphuric carbonate		☆☆		☆☆		
Calcium chloride	10%	☆☆	☆☆	☆☆		
Potassium chloride	10%	☆☆	☆☆	☆☆		
Sodium chloride	10%	☆☆	☆☆	☆☆		
Detergents	1%	☆☆	☆☆	☆☆	☆☆	☆☆
	25%	☆☆	☆☆	☆☆	☆☆	☆☆
Dibutylphtalate		☆☆	☆☆	☆☆		
Dichlorethane		-		☆☆		
Dioxane		☆☆	-	☆☆		
Water		☆☆	☆☆	☆☆	☆☆	☆☆
Bleach		☆☆	☆☆	☆☆		
Gas		☆☆		☆☆		
Turpentine		☆☆		☆☆	☆☆	☆☆

Agent	Polyester reinforced glass fiber			Polyamide		
	23°C	60°C	80°C	23°C	60°C	80°C
White spirit	☆☆			☆☆		
Ether	☆☆			☆☆		
Freon 11	☆☆			☆☆		
Glycerine	☆	☆☆		☆☆	☆☆	-
Glycol	☆☆	☆☆		☆☆	☆☆	-
Grease	☆☆	☆☆	☆☆	☆☆	☆☆	☆☆
Heptane	☆☆			☆☆		
Hexane	☆☆			☆☆		
Cotton seed oil	☆☆	☆☆	☆☆	☆☆	☆☆	☆☆
Silicon oil	☆☆	☆☆	☆☆	☆☆	☆☆	☆☆
Processing oil	☆☆	☆☆	☆☆	☆☆	☆☆	☆☆
Diesel oil	☆☆			☆☆		
Olive oil	☆☆	☆☆	☆☆	☆☆	☆☆	☆☆
Mineral oil	☆☆	☆☆	☆☆	☆☆	☆☆	☆☆
Engine oil	☆☆	☆☆	☆☆	☆☆	☆☆	☆☆
Plant oil	☆☆	☆☆	☆☆	☆☆	☆☆	☆☆
Ammonium hydroxide	10%	☆☆		☆☆		
	conc	-		☆☆		
Potassium hydroxide	1%	-	-	☆☆		
	10%	-	-	☆☆		
Sodium hydroxide	1%	-	-	☆☆		
	10%	-	-	☆☆		
Calcium hypochlorite	☆☆	☆☆		☆☆		
Sodium hypochlorite	10%	☆☆	☆☆	☆☆		
Isopropanol	☆☆	☆☆		☆☆		
Braking liquid	☆☆	☆☆	☆☆	☆☆		
Methylethycetone	☆☆	☆☆		☆☆		
Perchlorethylene	☆☆	☆☆		☆☆	☆☆	-
Potassium permanganate	10%	☆☆		☆☆		
Oil		-		☆☆		
Hydrogen peroxide	3%	☆☆		☆☆		
	30%	☆☆		☆☆		
Soap solution	1%	☆☆	-	☆☆		
Carbon tetrachloride	☆☆			☆☆		
Tetrahydrofurane	☆☆			☆☆		
Toluene	☆☆			☆☆		
Trichlorethylene	☆☆			☆☆	☆☆	☆☆
Vaseline	☆☆	☆☆	☆☆	☆☆	☆☆	☆☆
Xylene	☆☆			☆☆		

Legend: ☆☆☆ = Excellent ☆☆☆ = Good -- = Poor

Metal Materials

Casings – Metal casings providing even greater impact resistance are standard on some MELTRIC products and are optional on others. Depending upon the product line, these casings may be made of zamak, aluminum or stainless steel. Zamak, a zinc - aluminum alloy is the most commonly used. Zamak receptacles are blue epoxy coated and zamak plugs are specially treated to further improve corrosion resistance.

Contacts – All MELTRIC contact surfaces are made of solid silver-nickel with the exception of the PF and PFQ contacts which are solid pure silver. Silver-nickel and silver both provide excellent resistance to climatic conditions and to all known chemical agents found in industry with the exception of sulphuric acid. Products installed in sulphuric acid environments should have an environmental rating of at least Type 4X or IP66.

Accessories – Wall boxes, angles, and handles are in zamak or aluminum alloy. All zamak accessories are standardly protected by an epoxy paint.

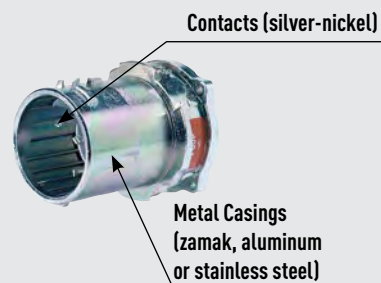

Products with Metal Zamak casings:

DS60, DS100c, DS100, DS200, DSN150

DSN150

DB30, DB60, DB100

DR100, DR150, DR250

PN7c, PN12c, DN7c, DN20c, DS7c, DR7c

Products with Aluminum Casings

PN (HT)

DX20, DX30, DX60, DX100

PFQ300, PF300, PF400, PF600

Products with Stainless Steel Casings

PN7c, PN12c

DS24c, DS37c

Contact customer service for availability of Stainless Steel on other products.

Resistance of Metal Casings to Corrosive Agents *

Agent	Protected Zamak or Aluminum
Dry lighting gas	☆☆
Water steam	☆
Hot water	☆
Artificial sea water	☆
Soluble oil 3%	☆
Soluble oil 5%	☆☆
Cleansing soap	☆☆
Potash solution 1%	☆
Potash solution 5%	☆
Ammonia 1%	☆
Ammonia 5%	☆
Sodium chloride 1%	☆
Sodium chloride 5%	☆
Acetic acid 1%	☆
Acetic acid 5%	-
Gas	☆☆
Engine oil	☆☆
Printing ink	☆
Ethyl or methyl alcohol	☆☆
Trichloethylene	☆
Dry insecticides	☆

Legend: ☆☆ = Excellent ☆ = Good - = Poor

*** Important Note:** These resistance charts are intended to give a general overview of the performance of our casings and mounting accessories. It is not intended to provide a guarantee of performance of our product as that will depend on the concentration of the chemical, the application temperature, the duration of the exposure, and other application specific factors. In cases where chemical compatibility may be in question the established practice is to place a representative sample device in the application environment to see how it holds up.

Watertightness / Ingress Protection (NEMA and IP ratings)

Environmental Ratings for MELTRIC Devices



Most MELTRIC products achieve rated watertightness as soon as the plug is fully inserted into the receptacle. The primary exception is the DB product line which requires the turning of a locking ring.

Product	Type	IP (plug + receptacle)	IP (receptacle alone)
DSN	4X	66/67	66/67
DS+	3R	54	55
DB	-	67	67
DXN	-	66/67	66/67
DXN25c/37c	-	66/67	66/67
DX	-	65	65
DN	-	54	55
PF/PFQ	-	66/67	66/67
DR+	3R	54	55
PN	-	66/67	66/67
PXN12c	-	65/66	65/66
SP	-	66/67	66/67
SPeX	-	66	66

+ Additional watertightness is available on DS and DR devices, see pg 214.

Environmental Ratings Explained:

NEMA/UL/CSA Enclosure Types (UL50)

Enclosure Type	Intended Use and Description
1	Indoor use primarily to provide a degree of protection against limited amounts of falling dirt.
2	Indoor use primarily to provide a degree of protection against limited amounts of waste and falling dirt.
3, 3R, 3S	Outdoor use primarily to provide a degree of protection against rain, sleet, and damage from external ice formation.
4, 4X	Indoor or outdoor use primarily to provide a degree of protection against windblown dust and rain, splashing water, hose-directed water, and damage from external ice formation.
12	Indoor use primarily to provide a degree of protection against circulating dust, falling dirt and dripping non-corrosive liquids.

IP Ratings (IEC/EN 60529)

First Digit		Second Digit	
Protection against the ingress of solid foreign objects and access to hazardous parts		Protection against the ingress of water with harmful effects	
0	No protection	0	No protection
1	50mm Back of hand	1	Vertically dripping water (condensation)
2	12.5mm Finger	2	Dripping water at 15°
3	2.5mm Tool	3	Spraying water at 60° (rain)
4	1mm Wire	4	Splashing water from any direction
5	Against Dust -	5	Jetting water from any direction
6	Dust-tight -	6	Powerful jetting water from any direction
-		7	Temporary submersion

Impact Resistance

MELTRIC product resistance to mechanical shocks is specified in accordance with their IK ratings.

MELTRIC Products IK Ratings (per IEC/EN 50102)

Product	Material	IK Rating
DSN	Poly	08 (5 Joules)
DS	Poly	08 (5 Joules)
DS	Metal	09 (10 Joules)
DB	Metal	09 (10 Joules)
DR	Poly	08 (5 Joules)
DR	Metal	09 (10 Joules)
DN	Metal	09 (10 Joules)
PN	Poly	08 (5 Joules)
PN/PXN12c	Metal	09 (10 Joules)
PF	Metal	10 (20 Joules)
DX	Metal	10 (20 Joules)
DXN	Poly	08 (5 Joules)
DXN25c/37c	Metal	09 (10 Joules)
SP/SPeX	Poly	08 (5 Joules)



Operating Temperatures

All MELTRIC plugs and receptacles (except SPeX) can be used with no particular precaution from -15°F to 140°F/-26°C to 60°C.

Hot Temperatures

Some devices that do not contain any polyamide can operate up to 175°F/80°C but precise conditions and duty cycles must be submitted to the MELTRIC engineering department for approval. A limited range of products are available for ambient temperatures up to 465°F/240°C. Contact MELTRIC customer service for more information.

Cold Temperatures

Below -15°F materials become more brittle and impact should be avoided, especially on polyamide materials. However, MELTRIC's metal and polyester casings can be used as low as -40°F/-40°C and some MELTRIC devices are in service at -75°F/-60°C. Consult factory for more information.

Note: SPeX temperature range Min -4°F/Max 140°F

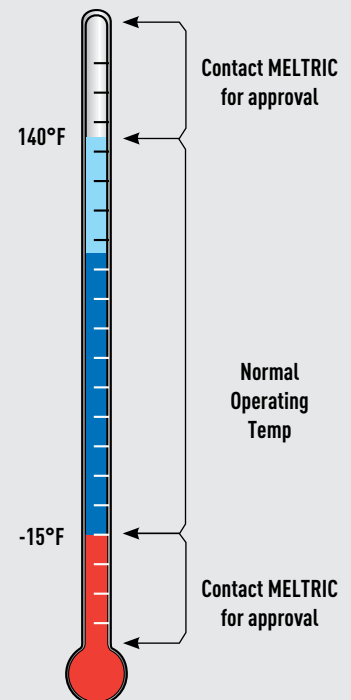

Color Coded Gaskets & Labels

For Voltage Identification

PIN CONFIGURATION	VOLTAGE RANGE	FREQUENCY	5th, 6th and 7th PART NUMBER DIGITS	RECEPTACLE/CONNECTOR		PLUG/INLET	
				COLOR GASKET	VOLTAGE STICKER	COLOR GASKET	VOLTAGE STICKER
1P+N+G	110 - 125V	60Hz	075	ORANGE	ORANGE	ORANGE	ORANGE
	120 - 127V	60Hz	165	YELLOW	YELLOW	YELLOW	YELLOW
	255 - 277V	60Hz	045	GREY	GREY	GREY	GREY
	347V	60Hz	145	RED	RED	RED	RED
	110 - 130V	50Hz	035	YELLOW	YELLOW	YELLOW	YELLOW
	220 - 250V	50Hz	015	BLUE	BLUE	BLUE	BLUE
	380 - 440V	50Hz	195	RED	RED	RED	RED
	577V	50Hz	225	BLACK	BLACK	BLACK	BLACK
	115 - 127V	200Hz	125	GREEN	YELLOW	GREEN	YELLOW
	115 - 127V	400Hz	115	GREEN	YELLOW	GREEN	YELLOW
2P	20 - 24V	60Hz	02A	VIOLET	VIOLET	VIOLET	VIOLET
	20 - 24V	50Hz	08A	VIOLET	VIOLET	VIOLET	VIOLET
	25 - 28V	50Hz	06A	VIOLET	VIOLET	VIOLET	VIOLET
	40 - 48V	50Hz	13A	WHITE	WHITE	WHITE	WHITE
2P+G	208 - 220V	60Hz	162	BLUE	BLUE	BLUE	BLUE
	220 - 250V	60Hz	072	ORANGE	ORANGE	ORANGE	ORANGE
	440 - 480V	60Hz	042	RED	RED	RED	RED
	600V	60Hz	142	BLACK	BLACK	BLACK	BLACK
	190 - 230V	50Hz	032	BLUE	BLUE	BLUE	BLUE
	380 - 440V	50Hz	012	RED	RED	RED	RED
	480 - 500V	50Hz	092	BLACK	BLACK	BLACK	BLACK
	660 - 690V	50Hz	192	BLACK	BLACK	BLACK	BLACK
	1000V	50Hz	222	BLACK	BLACK	BLACK	BLACK
	200 - 220V	200Hz	122	GREEN	BLUE	GREEN	BLUE
	200 - 220V	400Hz	112	GREEN	BLUE	GREEN	BLUE
	110 - 130V	DC	109	YELLOW	YELLOW	YELLOW	YELLOW
	220 - 250V	DC	209	BLUE	BLUE	BLUE	BLUE

PIN CONFIGURATION	VOLTAGE RANGE	FREQUENCY	5th, 6th and 7th PART NUMBER DIGITS	RECEPTACLE/CONNECTOR		PLUG/INLET		
				COLOR GASKET	VOLTAGE STICKER	COLOR GASKET	VOLTAGE STICKER	
2P+N+G	<u>110 - 125V</u> 220 - 250V	60Hz	076	ORANGE	ORANGE	ORANGE	ORANGE	
	<u>120 - 127V</u> 208 - 220V	60Hz	166	BLUE	YELLOW BLUE	BLUE	YELLOW BLUE	
	<u>255 - 277V</u> 440 - 480V	60Hz	046	RED	GREY RED	RED	GREY RED	
	347 - 600V	60Hz	146	BLACK	RED BLACK	BLACK	RED BLACK	
	<u>110 - 130V</u> 190 - 230V	50Hz	036	BLUE	YELLOW BLUE	BLUE	BLUE	
	<u>220 - 250V</u> 380 - 440V	50Hz	016	RED	BLUE RED	RED	RED	
	<u>380 - 400V</u> 660 - 690V	50Hz	196	BLACK	RED BLACK	BLACK	BLACK	
	480 - 500V	50Hz	096	BLACK	BLACK	BLACK	BLACK	
	<u>115 - 127V</u> 200 - 220V	200Hz	126	GREEN	YELLOW BLUE	GREEN	BLUE	
	<u>115 - 127V</u> 200 - 220V	400Hz	116	GREEN	YELLOW BLUE	GREEN	BLUE	
	3P+G	208 - 220V	60Hz	163	BLUE	BLUE	BLUE	BLUE
		220 - 250V	60Hz	073	ORANGE	ORANGE	ORANGE	ORANGE
		440 - 480V	60Hz	043	RED	RED	RED	RED
		600V	60Hz	143	BLACK	BLACK	BLACK	BLACK
190 - 230V		50Hz	033	BLUE	BLUE	BLUE	BLUE	
380 - 440V		50Hz	013	RED	RED	RED	RED	
480 - 500V		50Hz	093	BLACK	BLACK	BLACK	BLACK	
660 - 690V		50Hz	193	BLACK	BLACK	BLACK	BLACK	
1000V		50Hz	223	BLACK	BLACK	BLACK	BLACK	
200 - 220V		200Hz	123	GREEN	BLUE	GREEN	BLUE	
200 - 220V		400Hz	113	GREEN	BLUE	GREEN	BLUE	
3P+N+G		<u>110 - 125V</u> 220 - 250V	60Hz	077	ORANGE	ORANGE	ORANGE	ORANGE
	<u>120 - 127V</u> 208 - 220V	60Hz	167	BLUE	YELLOW BLUE	BLUE	YELLOW BLUE	
	<u>255 - 277V</u> 440 - 480V	60Hz	047	RED	GREY RED	RED	GREY RED	
	347 - 600V	60Hz	147	BLACK	RED BLACK	BLACK	RED BLACK	
	<u>110 - 130V</u> 190 - 230V	50Hz	037	BLUE	YELLOW BLUE	BLUE	BLUE	
	<u>220 - 250V</u> 380 - 440V	50Hz	017	RED	BLUE RED	RED	RED	
	<u>380 - 400V</u> 660 - 690V	50Hz	197	BLACK	RED BLACK	BLACK	BLACK	
	480 - 500V	50Hz	097	BLACK	BLACK	BLACK	BLACK	
	<u>115 - 127V</u> 200 - 220V	200Hz	127	GREEN	YELLOW BLUE	GREEN	BLUE	
	<u>115 - 127V</u> 200 - 220V	400Hz	117	GREEN	YELLOW BLUE	GREEN	BLUE	
	MULTIPIN	NOT SPECIFIED			SKY BLUE	SKY BLUE	SKY BLUE	SKY BLUE

Index

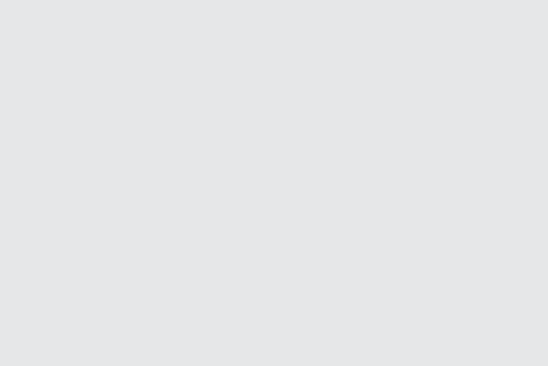
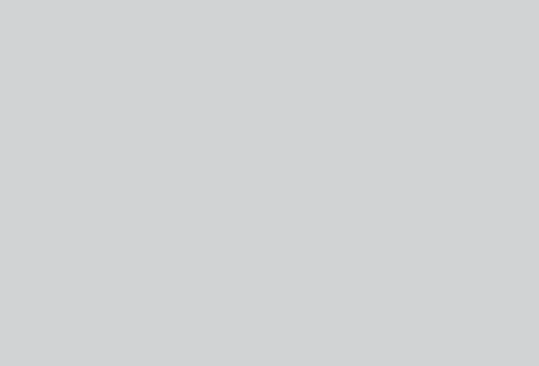
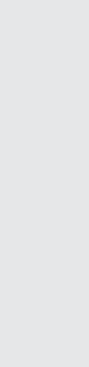
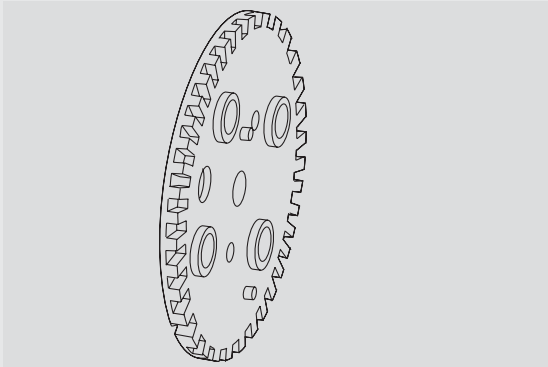
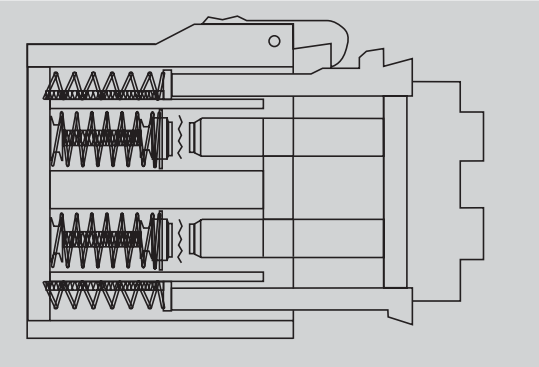
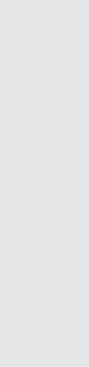
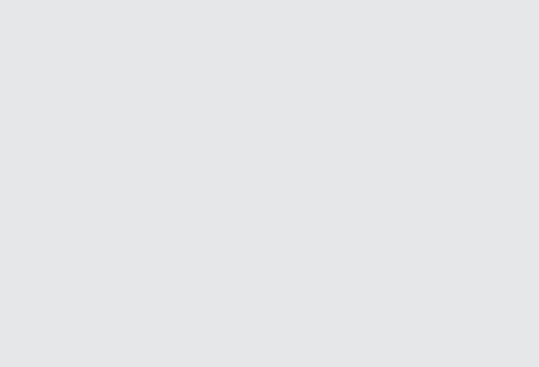
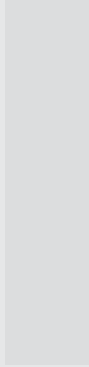
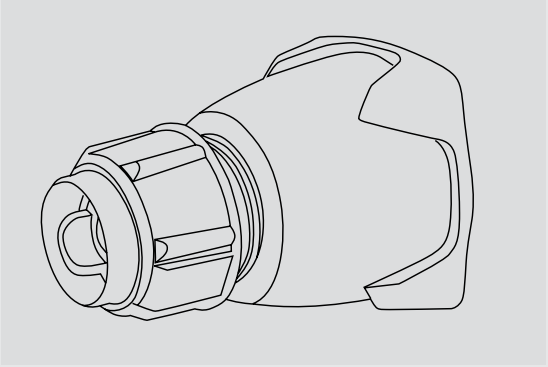
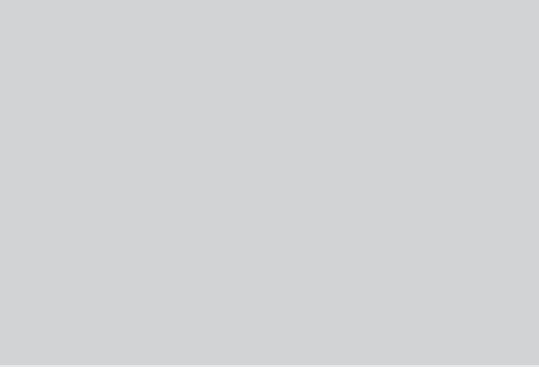

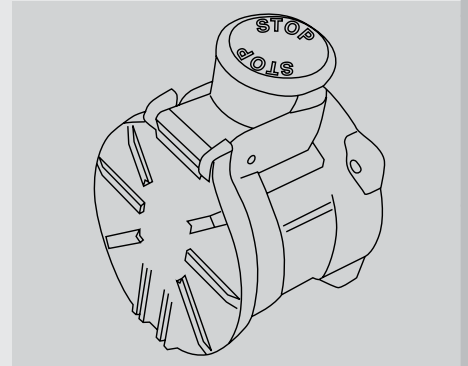
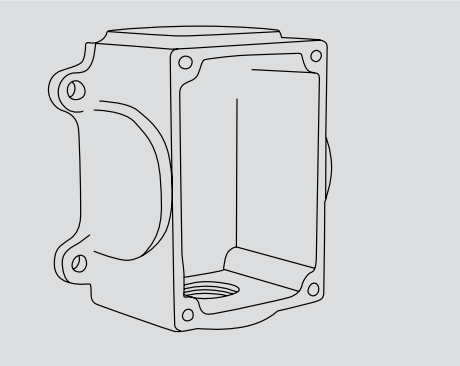

INDEX

Suffix Index	p. 239
Part Number Index	p. 241
Literature Order Form	p. 252

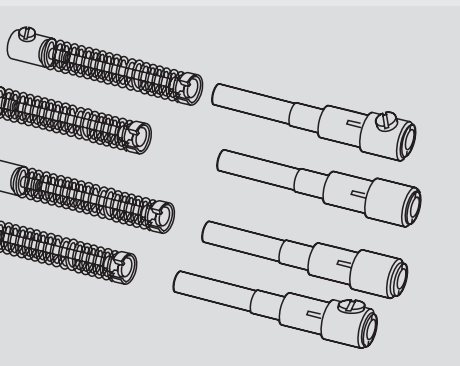
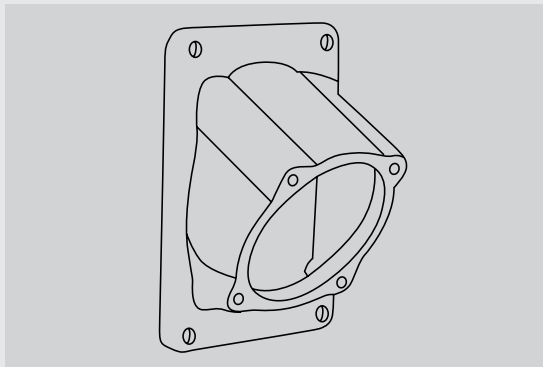

Suffixes

Quick Reference Table

Suffix	Description	Applicable Products	Special Instructions
-001	Reverse interior for PN, DSN24, DSN37 device only	PN, DSN24, DSN37	Add to inlet and receptacle part numbers
-026	Black device gasket	DS, DR, DSN	
-080	Junction box with angle	All	
-1	1" NPT thread size for conduit entry	DSN, DS, DR, DX, PN, DN, DB	Add to applicable accessories
-112	1 1/2" NPT thread size for conduit entry	DSN, DS, DR, DX, DN, DB	Add to applicable accessories
-12	1/2" NPT thread size for conduit entry	DS, DR, DX, DN, DB	Add to applicable accessories
-114	1 1/4" NPT thread size for conduit entry	DSN, DS, DR, DX, PN, DN, DXN, DB	Add to applicable accessories
-172	Two auxiliary pilot contacts	DS200, DS100, DB30, DB60	Add to inlet and receptacle part number
-173	Three auxiliary pilot contacts	DS200, DS100	Add to inlet and receptacle part number
-174	Four auxiliary pilot contacts	DS200, DS100, DB100	Add to inlet and receptacle part number
-175	Five auxiliary pilot contacts	DS200, DS100	Add to inlet and receptacle part number
-180	180° lid opening for flush mounted inlets	DS100, DS200, DR150, DR250	Add to the receptacle part number
-185	High temp product	PN	Add to inlet or receptacle part number
-2	2" NPT thread size for conduit entry	DS, DR, DX, DN, DB	Add to applicable accessories
-200	Cable range for PF/PFQ Handle 2.000" - 2.125"	PF/PFQ	Add to the handle part number
-20	2" NPT fitting size	PF/PFQ	Add to PF/PFQ junction box
-20P	Cable range .28" - .41"	DXN20, DXN30	Add to plug/connector part number
-212	2 1/2" NPT thread size for conduit entry	DS, DR, DN	
-225	Cable range for PF/PFQ Handle 2.125" - 2.375"	PF/PFQ	Add to the handle part number
-237	Cable range for PF/PFQ Handle 2.25" - 2.375"	PF/PFQ	Add to the handle part number
-25	2 1/2" NPT fitting size	PF/PFQ	Add to PF/PFQ junction box
-25P	Cable range .35" - .67"	DXN	Add to plug/connector part number
-250	Cable range for PF/PFQ Handle 2.375" - 2.5"	PF/PFQ	Add to the handle part number
-263	Three auxiliary pilot contacts	DS60, DS100C, DR100	Add to inlet and receptacle part number
-270	Auxiliary switch for female devices	DS, DSN, DR	Add to receptacle part number
-275	Cable range for PF/PFQ Handle 2.5" - 2.75"	PF/PFQ	Add to the handle part number
-30	3" NPT fitting size	PF/PFQ	Add to PF/PFQ junction box
-300	Cable range for PF/PFQ Handle 2.75" - 3"	PF/PFQ	Add to the handle part number
-30A	30A capacity for PN devices	PN	Add to inlet & receptacle part numbers
-312	Cable range for PF/PFQ Handle 3" - 3.125"	PF/PFQ	Add to the handle part number
-32P	Cable range .43" - .83"	DXN	Add to plug/connector part number
-335	Cable range for PF/PFQ Handle 3.125" - 3.35"	PF/PFQ	Add to the handle part number
-338	PRL release pawl	DSN, DS20, DS30, DS60, DS100C, DS100, DN	Add to inlet part number
-338-A188	PRL release pawl with straight insertion	DS200	Add to inlet part number
-34	3/4" NPT thread size for conduit entry	DSN, DS, DR, DX, PN, DN, DXN, DB	Add to applicable accessories
-348-A188	SRL release pawl with straight insertion for receptacles	DS200	Add to receptacle part number
-352	Straight insertion	DSN, DS20, DS30, DS60, DS100C, DS100, DN	Add to inlet part number

Suffix	Description	Applicable Products	Special Instructions
-354	SRL release pawl with straight insertion for receptacles	DSN,DS20,DS30,DS60,DS100C,DS100,DN	Add to receptacle part number
-35	3 1/2" NPT fitting size	PF/PFQ	Add to PF/PFQ junction box
-350	Cable range for PF/PFQ Handle 3.35" - 3.5"	PF/PFQ	Add to the handle part number
-375	Mushroom Pawl	DS, DSN, DR	Add to receptacle part number
-375-843	Padlockable Mushroom Pawl	DS, DSN, DR, DN	Add to receptacle part number
-3NF	Non functioning contact to activate auxiliary switch	DS, DSN	Activates 2 Pole 4 wire receptacle.
-40	4 NPT fitting size	PF/PFQ	Add to PF/PFQ junction box
-40P	Cable range .75" - 1.10"	DXN	Add to plug/connector part number
-473	Finger drawplate on handle	DS	Add to handle part number
-48	Inlet or receptacle without cap	PF, DB	Add to inlet and receptacle part number
-4X	Type 4X watertightness	DS, DR	Add to inlet and receptacle
-601	Special adapter plate for DSN1 angle on junction box	DSN20	
-824	Metal pawl for poly receptacles	DS, DSN, DR	
-824-300	Locking pawls	PN	Add to the receptacle part number
-843	Padlock pawl	DS, DSN, DR	Add to receptacle part number
-845	Oversize padlock pawl	DS, DR	Add to receptacle part number
-924	Metal Pawl for Poly Receptacles	DXN	Add to Receptacle part number
-972	Two auxiliary pilot contacts	DS20-60, DSN30-60, DR30-100	Add to inlet and receptacle part number
-973	Three auxiliary pilot contacts	DSN60, DS30-60, DR50	Add to inlet and receptacle part number
-974	Four auxiliary pilot contacts	DS30, DS60, DSN60	Add to inlet and receptacle part number
-A06	Allows up to 4/0 AWG wiring capacity	DS200, DR250	Add to inlet and receptacle part number
-A155	Inlet without the standard lockout hole	DS, DSN	Add to inlet part number
-A188	Straight insertion	DS200	Add to inlet and receptacle part number
-B	Bottom interior piece	All	
-CG	Cable guide for PRL or SRL release pawl for handle	DS, DSN, DN	Add to handle part number
-C-***	Suffixes for DS100C inlets & receptacles	DS	Included in inlet/receptacle part number
-E323	Allows up to 2/0 AWG wiring capacity	DS100, DR150	
-HP	High pressure water protection	DN	Add to inlet and receptacle part number
-K**	Voltage being used when notching position is not standard	All	Add to inlet and receptacle part number
-LC	Less cover	DS, DSN	Add to receptacle part number
-MTR	Phase Rotation Meter	DS, DSN, DR, DB	Add to Plug
-NC	Normally closed lid	DS, DSN, DR, DN	Add to receptacle part number
-NNF	Non Functioning Neutral - Activates 3 Pole 4 wire receptacle	DS, DSN, DR	Add to inlet part number
-NP	No paint on accessories	All accessories	
-R	Normally closed lid	DXN	Add to receptacle part number
-SS	Stainless steel	PN7, PN12, DS	
-T	Top interior piece	All	

Parts Index

Part Number	Pages	Part Number	Pages	Part Number	Pages	Part Number	Pages	Part Number	Pages
01-2A010	123	01-NA013-12	74*	07-A4001	73	09-N4142	113	09-S4162	113
01-2A010-185	123	01-NA013-34	74*	07-A4001-SS	75	09-N4143	113	09-S4163	113
01-2A010-185-B	123	01-NA014	89*	07-A8001	73	09-N4147	113	09-S4167	113
01-2A010-185-T	123	01-NA023-12	74*	07-A8001-SS	75	09-N4162	113	09-SA024	124
01-2A010-B	123	01-NA023-34	74*	09-04041-SS	71	09-N4163	113	17-14051	81
01-2A010-T	123	01-NA024	95	09-04051-SS	71	09-N4167	113	17-14060	81
01-2A011	123	01-NA025-12	74*	09-04061-SS	71	09-N8042	113	17-14061	81
01-2A011-185	123	01-NA025-34	74*	09-08041-SS	71	09-N8043	113	17-14070	81
01-2A020	124	01-NA027	74*	09-08051-SS	71	09-N8045	113	17-14071	81
01-2A020-185	124	01-NA053-080-12	74*	09-08061-SS	71	09-N8047	113	17-14080	81
01-2A020-185-B	124	01-NA126	74*	09-24012-185	121	09-N8072	113	17-14081	81
01-2A020-185-T	124	01-NA313	74*	09-24013-185	121	09-N8073	113	17-14090	81
01-2A020-B	124	01-NA583	123*	09-24015-185	121	09-N8075	113	17-18051	81
01-2A020-T	124	01-P4041	71	09-24016-185	121	09-N8076	113	17-18060	81
01-2A021	124	01-P4051	71	09-24017-185	121	09-N8142	113	17-18061	81
01-2A021-185	124	01-P4061	71	09-24032-185	121	09-N8143	113	17-18070	81
01-2A142	74*	01-P8041	71	09-24033-185	121	09-N8147	113	17-18071	81
01-AA113	95	01-P8051	71	09-24035-185	121	09-N8162	113	17-18080	81
01-AA910	95	01-P8061	71	09-24037-185	121	09-N8163	113	17-18081	81
01-AA920	96	01-PA910	95	09-28012-185	121	09-N8167	113	17-18090	81
01-MA911	95	01-PA920	96	09-28013-185	121	09-NA014	89*	17-64091	83
01-N4042	113	01-S4042	113	09-28015-185	121	09-NA024	90*	17-64100	83
01-N4043	113	01-S4043	113	09-28016-185	121	09-NA025-12	74*	17-64101	83
01-N4045	113	01-S4045	113	09-28017-185	121	09-NA025-34	74*	17-64110	83
01-N4047	113	01-S4047	113	09-28032-185	121	09-NA027	74*	17-64111	83
01-N4072	113	01-S4072	113	09-28033-185	121	09-NA053-080-12	74*	17-64120	83
01-N4073	113	01-S4073	113	09-28035-185	121	09-NA053-080-12-185	122	17-64121	83
01-N4075	113	01-S4075	113	09-28037-185	121	09-P4041	71	17-64130	83
01-N4076	113	01-S4076	113	09-2A013-SS-12	76	09-P4051	71	17-64131	83
01-N4142	113	01-S4142	113	09-2A013-SS-34	72*	09-P4061	71	17-64140	83
01-N4143	113	01-S4143	113	09-2A014-185	123	09-P8041	71	17-64141	83
01-N4162	113	01-S4147	113	09-2A024-185	124	09-P8051	71	17-64150	83
01-N4163	113	01-S4162	113	09-2A025-185-12	122	09-P8061	71	17-64151	83
01-N4167	113	01-S4163	113	09-2A025-185-34	122	09-PA910	95	17-64160	83
01-N8042	113	01-S4167	113	09-2A027-185	122	09-PA911	95	17-64161	83
01-N8043	113	03-A4001	73	09-2A027-SS	76*	09-PA919	95	17-64170	83
01-N8045	113	03-A8001	73	09-2A053-080-SS-1	76*	09-PA920	96	17-64171	83
01-N8047	113	04-2A090-5-10	74*	09-2A583	123*	09-PA921	96	17-64180	83
01-N8072	113	04-2A090-5-12	74*	09-2A583-185	123*	09-PA929	96	17-64181	83
01-N8073	113	04-2A090-5-34	74*	09-2A913-67	122	09-S4042	113	17-64190	83
01-N8075	113	06-A0001	206	09-AA910	95	09-S4043	113	17-64191	83
01-N8076	113	06-A0001-25M	206	09-AA920	96	09-S4045	113	17-64200	83
01-N8142	113	06-A1001	206	09-N4042	113	09-S4047	113	17-68091	83
01-N8143	113	06-A1001-25M	206	09-N4043	113	09-S4072	113	17-68100	83
01-N8147	113	06-A3001	206	09-N4045	113	09-S4073	113	17-68101	83
01-N8162	113	06-A3001-25M	206	09-N4047	113	09-S4075	113	17-68110	83
01-N8163	113	06-A6001	206	09-N4072	113	09-S4076	113	17-68111	83
01-N8167	113	06-A6001-25M	206	09-N4073	113	09-S4142	113	17-68120	83
01-NA013	74*	06-A7001	206	09-N4075	113	09-S4143	113	17-68121	83
01-NA013-1	74*	06-A9001	206	09-N4076	113	09-S4147	113	17-68130	83

Part Number	Pages	Part Number	Pages	Part Number	Pages	Part Number	Pages	Part Number	Pages
17-68131	83	22-14045	179	22-38042	181	22-68076	183	25-34015	181
17-68140	83	22-14047	179	22-38043	181	22-68142	183	25-34017	181
17-68141	83	22-14072	179	22-38045	181	22-68143	183	25-34033	181
17-68150	83	22-14073	179	22-38047	181	22-68147	183	25-3408A	181
17-68151	83	22-14075	179	22-38072	181	22-68162	183	25-34093	181
17-68160	83	22-14076	179	22-38073	181	22-68163	183	25-34097	181
17-68161	83	22-14162	179	22-38075	181	22-68167	183	25-38013	181
17-68170	83	22-14163	179	22-38076	181	22-6A013-1	184	25-38015	181
17-68171	83	22-14167	179	22-38142	181	22-6A013-25P	184	25-38017	181
17-68181	83	22-18042	179	22-38143	181	22-6A013-32P	184	25-38033	181
17-68190	83	22-18043	179	22-38147	181	22-6A013-40P	184	25-3808A	181
17-68191	83	22-18045	179	22-38162	181	22-6A023-1-B	184	25-38093	181
17-68200	83	22-18047	179	22-38163	181	22-6A023-1-T	184	25-38097	181
19-1A014	95	22-18072	179	22-38167	181	22-6A027	184	25-3A027	182
19-1A024	96	22-18073	179	22-3A013-1	182	22-6A058-1	184	25-3A088-20P	182
19-1A711	95	22-18075	179	22-3A013-20P	182	22-6A058-112	184	25-3A088-25P	182
19-1A721	96	22-18076	179	22-3A013-25P	182	22-6A058-114	184	25-3A088-32P	182
19-1A910	95	22-18162	179	22-3A013-32P	182	22-6A058-12	184	25-3A253-20M	182
19-1A911	95	22-18163	179	22-3A013-34	182	22-6A058-34	184	25-3A253-25M	182
19-1A920	96	22-18167	179	22-3A013-40P	182	22-6AB58	184	25-3A253-32M	182
19-1A921	96	22-1A013-12	180	22-3A023-34-B	182	25-14013	179	25-3A253-32P	182
19-1A925	96	22-1A013-20P	180	22-3A023-34-T	182	25-14015	179	25-3A253-40P	182
19-34061	89	22-1A013-25P	180	22-3A027	182	25-14017	179	25-3A753	182
19-38061	89	22-1A013-32P	180	22-3A058-1	182	25-14033	179	25-3A757	182
19-64061	89	22-1A013-34	180	22-3A058-112	182	25-1408A	179	25-3A783	182
19-68061	89	22-1A023-12-B	180	22-3A058-114	182	25-14093	179	25-3AB53	182
19-6A013-1	89	22-1A023-12-T	180	22-3A058-12	182	25-14097	179	25-3AB53-25P	182
19-6A013-112	89	22-1A023-34-B	180	22-3A058-34	182	25-18013	179	25-3AB88-20P	182
19-6A013-114	89	22-1A023-34-T	180	22-3AB58	182	25-18015	179	25-3AB88-25P	182
19-6A013-2	89	22-1A027	180	22-64042	183	25-18017	179	25-3AB88-32P	182
19-6A013-34	89	22-1A058-1	180	22-64043	183	25-18033	179	25-64013	183
19-6A711	95	22-1A058-112	180	22-64045	183	25-1808A	179	25-64015	183
19-6A721	96	22-1A058-114	180	22-64047	183	25-18093	179	25-64017	183
19-6A910	95	22-1A058-12	180	22-64072	183	25-18097	179	25-64033	183
19-6A911	95	22-1A058-34	180	22-64073	183	25-1A027	180	25-6408A	183
19-6A920	96	22-1A426	180	22-64075	183	25-1A088-20P	180	25-64093	183
19-6A921	96	22-34042	181	22-64076	183	25-1A088-25P	180	25-64097	183
19-6A925	96	22-34043	181	22-64142	183	25-1A253-25M	180	25-68013	183
1H1SS	78	22-34045	181	22-64143	183	25-1A253-25P	180	25-68015	183
1PH1	40*	22-34047	181	22-64147	183	25-1A253-32M	180	25-68017	183
1PH114	40*	22-34072	181	22-64162	183	25-1A253-32P	180	25-68033	183
1PH12	40*	22-34073	181	22-64163	183	25-1A53-20M	180	25-6808A	183
1PH34	40*	22-34075	181	22-64167	183	25-1A753	180	25-68093	183
1PM514	28*	22-34076	181	22-68042	183	25-1A757	180	25-68097	183
1PM516	28*	22-34142	181	22-68043	183	25-1AB53	180	25-6A027	184
1PM518	28*	22-34143	181	22-68045	183	25-1AB53-25P	180	25-6A088-20P	184
1PM520	28*	22-34147	181	22-68047	183	25-1AB88-20P	180	25-6A088-25P	184
1PM522	28*	22-34162	181	22-68072	183	25-1AB88-25P	180	25-6A088-32P	184
22-14042	179	22-34163	181	22-68073	183	25-1AB88-32P	180	25-6A088-40P	184
22-14043	179	22-34167	181	22-68075	183	25-34013	181	25-6A253-20M	184

Note: * This part number is also displayed on other pages.

Parts Index

Part Number	Pages	Part Number	Pages	Part Number	Pages	Part Number	Pages	Part Number	Pages
25-6A253-20P	184	26-24045	199	26-33042-XXX	200	26-60163-XX	201	26-6A023-1	201
25-6A253-25M	184	26-24047	199	26-33043-XXX	200	26-60167-XX	201	26-6A023-112	201
25-6A253-32M	184	26-24072	199	26-33045-XXX	200	26-61042-XXX	201	26-6A023-114	201
25-6A253-32P	184	26-24073	199	26-33047-XXX	200	26-61043-XXX	201	26-6A023-2	201
25-6A253-40P	184	26-24075	199	26-33072-XXX	200	26-61045-XXX	201	26-6A126	201
25-6A753	184	26-24076	199	26-33073-XXX	200	26-61047-XXX	201	26-90042-XX	202
25-6A757	184	26-24143	199	26-33075-XXX	200	26-61072-XXX	201	26-90043-XX	202
25-6AB53	184	26-24162	199	26-33076-XXX	200	26-61073-XXX	201	26-90045-XX	202
25-6AB88-20P	184	26-24163	199	26-33143-XXX	200	26-61075-XXX	201	26-90047-XX	202
25-6AB88-25P	184	26-24167	199	26-33162-XXX	200	26-61076-XXX	201	26-90072-XX	202
25-6AB88-32P	184	26-26042-XX	199	26-33163-XXX	200	26-61143-XXX	201	26-90073-XX	202
25-6AB88-40P	184	26-26043-XX	199	26-33167-XXX	200	26-61162-XXX	201	26-90075-XX	202
26-20042-XX	199	26-26045-XX	199	26-34042	200	26-61163-XXX	201	26-90076-XX	202
26-20043-XX	199	26-26047-XX	199	26-34043	200	26-61167-XXX	201	26-90143-XX	202
26-20045-XX	199	26-26072-XX	199	26-34045	200	26-63042-XXX	201	26-90162-XX	202
26-20047-XX	199	26-26073-XX	199	26-34047	200	26-63043-XXX	201	26-90163-XX	202
26-20072-XX	199	26-26075-XX	199	26-34072	200	26-63045-XXX	201	26-90167-XX	202
26-20073-XX	199	26-26076-XX	199	26-34073	200	26-63047-XXX	201	26-93042-XXX	202
26-20075-XX	199	26-26143-XX	199	26-34075	200	26-63072-XXX	201	26-93043-XXX	202
26-20076-XX	199	26-26162-XX	199	26-34076	200	26-63073-XXX	201	26-93045-XXX	202
26-20143-XX	199	26-26163-XX	199	26-34143	200	26-63075-XXX	201	26-93047-XXX	202
26-20162-XX	199	26-26167-XX	199	26-34162	200	26-63076-XXX	201	26-93072-XXX	202
26-20163-XX	199	26-2A023-1	199	26-34163	200	26-63143-XXX	201	26-93073-XXX	202
26-20167-XX	199	26-2A023-12	199	26-34167	200	26-63162-XXX	201	26-93075-XXX	202
26-21042-XXX	199	26-2A023-34	199	26-36042-XX	200	26-63163-XXX	201	26-93076-XXX	202
26-21043-XXX	199	26-2A126	199	26-36043-XX	200	26-63167-XXX	201	26-93143-XXX	202
26-21045-XXX	199	26-30042-XX	200	26-36045-XX	200	26-64042	201	26-93162-XXX	202
26-21047-XXX	199	26-30043-XX	200	26-36047-XX	200	26-64043	201	26-93163-XXX	202
26-21072-XXX	199	26-30045-XX	200	26-36072-XX	200	26-64045	201	26-93167-XXX	202
26-21073-XXX	199	26-30047-XX	200	26-36073-XX	200	26-64047	201	26-94042	202
26-21075-XXX	199	26-30072-XX	200	26-36075-XX	200	26-64072	201	26-94043	202
26-21076-XXX	199	26-30073-XX	200	26-36076-XX	200	26-64073	201	26-94045	202
26-21143-XXX	199	26-30075-XX	200	26-36143-XX	200	26-64075	201	26-94047	202
26-21162-XXX	199	26-30076-XX	200	26-36162-XX	200	26-64076	201	26-94072	202
26-21163-XXX	199	26-30143-XX	200	26-36163-XX	200	26-64143	201	26-94073	202
26-21167-XXX	199	26-30162-XX	200	26-36167-XX	200	26-64162	201	26-94075	202
26-23042-XXX	199	26-30163-XX	200	26-3A023-1	200	26-64163	201	26-94076	202
26-23043-XXX	199	26-30167-XX	200	26-3A023-12	200	26-64167	201	26-94143	202
26-23045-XXX	199	26-31042-XXX	200	26-3A023-34	200	26-66042-XX	201	26-94162	202
26-23047-XXX	199	26-31043-XXX	200	26-3A126	200	26-66043-XX	201	26-94163	202
26-23072-XXX	199	26-31045-XXX	200	26-60042-XX	201	26-66045-XX	201	26-94167	202
26-23073-XXX	199	26-31047-XXX	200	26-60043-XX	201	26-66047-XX	201	26-9A023-1	202
26-23075-XXX	199	26-31072-XXX	200	26-60045-XX	201	26-66072-XX	201	26-9A023-112	202
26-23076-XXX	199	26-31073-XXX	200	26-60047-XX	201	26-66073-XX	201	26-9A023-114	202
26-23143-XXX	199	26-31075-XXX	200	26-60072-XX	201	26-66075-XX	201	26-9A023-2	202
26-23162-XXX	199	26-31076-XXX	200	26-60073-XX	201	26-66076-XX	201	26-9A126	202
26-23163-XXX	199	26-31143-XXX	200	26-60075-XX	201	26-66143-XX	201	26-9A126	202
26-23167-XXX	199	26-31162-XXX	200	26-60076-XX	201	26-66162-XX	201	29-10013	188
26-24042	199	26-31163-XXX	200	26-60143-XX	201	26-66163-XX	201	29-10015	188
26-24043	199	26-31167-XXX	200	26-60162-XX	201	26-66167-XX	201	29-10017	188

Part Number	Pages	Part Number	Pages	Part Number	Pages	Part Number	Pages	Part Number	Pages
29-11013-XXX	188	31-18242-K04	95	31-34951	87	31-3A911-172	95	31-6A020-B	52*
29-11015-XXX	188	31-18243-K04	95	31-34960	87	31-3A919	95	31-6A020-C	52
29-11017-XXX	188	31-18245-K04	95	31-34961	87	31-3A920-263	96	31-6A020-C-B	52
29-13013-XXX	188	31-18247-K04	95	31-34970	87	31-3A921	96	31-6A020-C-T	52
29-13015-XXX	188	31-1A010	51*	31-38172-K07	97	31-3A921-172	96	31-6A020-T	52*
29-13017-XXX	188	31-1A010-B	51*	31-38173-K07	97	31-3A929	96	31-6A021	52*
29-16013-XXX	188	31-1A010-T	51*	31-38175-K07	97	31-3AB26	51*	31-6A021-C	52
29-16015-XXX	188	31-1A011	51*	31-38176-K07	97	31-3AC26	51*	31-6A024	52*
29-16017-XXX	188	31-1A014	51*	31-38182-K14	97	31-3AM26	95	31-6A053-080-1	44*
29-17013	188	31-1A020	52*	31-38183-K14	97	31-3AN26	51*	31-6A053-080-112	44*
29-17015	188	31-1A020-B	52*	31-38187-K14	97	31-3AR26	51*	31-6A053-080-114	44*
29-17017	188	31-1A020-T	52*	31-38232-K16	97	31-611	44*	31-6A053-080-2	44*
29-19013	188	31-1A021	52*	31-38233-K16	97	31-64172-K07	99	31-6A066	214
29-19015	188	31-1A024	52*	31-38235-K16	97	31-64173-K07	99	31-6A110-C	51
29-19017	188	31-1A053-080-1	40*	31-38237-K16	97	31-64175-K07	99	31-6A226	44*
2H1	50*	31-1A053-080-114	40	31-38242-K04	97	31-64176-K07	99	31-6A310-972	51
2H112	50*	31-1A053-080-12	40	31-38243-K04	97	31-64182-K14	99	31-6A310-C-972	51
2H114	50*	31-1A053-080-34	40	31-38245-K04	97	31-64183-K14	99	31-6A320-972	52
2H2	50*	31-1A056	214	31-38247-K04	97	31-64187-K14	99	31-6A320-C-972	52
2H212	50*	31-1A226	40*	31-38931	87	31-64232-K16	99	31-6A426	44*
2PH112	50*	31-1A310-972	51	31-38940	87	31-64233-K16	99	31-6A583	51*
2PH2	50*	31-1A320-972	52	31-38941	87	31-64235-K16	99	31-6AB26	51*
2PH212	50*	31-1A320-C-972	52	31-38950	87	31-64237-K16	99	31-6AC26	51*
31-111	40*	31-1A426	40*	31-38951	87	31-64242-K04	99	31-6AM26	89*
31-14172-K07	95	31-1A583	51*	31-38960	87	31-64243-K04	99	31-6AN26	51*
31-14173-K07	95	31-1AB26	51*	31-38961	87	31-64245-K04	99	31-6AR26	51*
31-14175-K07	95	31-1AC26	51*	31-38970	87	31-64247-K04	99	31-94172-K07	101
31-14176-K07	95	31-1AN26	51*	31-3A010	51*	31-68172-K07	99	31-94173-K07	101
31-14182-K14	95	31-1AR26	51*	31-3A010-B	51*	31-68173-K07	99	31-94175-K07	101
31-14183-K14	95	31-2A126	50*	31-3A010-T	51*	31-68175-K07	99	31-94176-K07	101
31-14187-K14	95	31-311	82*	31-3A011-380	51*	31-68182-K14	99	31-94182-K14	101
31-14232-K16	95	31-34172-K07	97	31-3A014	51*	31-68183-K14	99	31-94183-K14	101
31-14233-K16	95	31-34173-K07	97	31-3A020	52*	31-68187-K14	99	31-94187-K14	101
31-14235-K16	95	31-34175-K07	97	31-3A020-B	52*	31-68232-K16	99	31-94232-K16	101
31-14237-K16	95	31-34176-K07	97	31-3A020-T	52*	31-68233-K16	99	31-94233-K16	101
31-14242-K04	95	31-34182-K14	97	31-3A021-380	52*	31-68235-K16	99	31-94235-K16	101
31-14243-K04	95	31-34183-K14	97	31-3A024	52*	31-68237-K16	99	31-94237-K16	101
31-14245-K04	95	31-34187-K14	97	31-3A026	95	31-68242-K04	99	31-94242-K04	101
31-14247-K04	95	31-34232-K16	97	31-3A053-080-1	42*	31-68243-K04	99	31-94243-K04	101
31-18172-K07	95	31-34233-K16	97	31-3A053-080-114	42	31-68245-K04	99	31-94245-K04	101
31-18173-K07	95	31-34235-K16	97	31-3A053-080-12	42	31-68247-K04	99	31-94247-K04	101
31-18175-K07	95	31-34237-K16	97	31-3A053-080-34	42	31-6A010	51*	31-98172-K07	101
31-18176-K07	95	31-34242-K04	97	31-3A056	214	31-6A010-B	51*	31-98173-K07	101
31-18182-K14	95	31-34243-K04	97	31-3A226	42*	31-6A010-C-B	51	31-98175-K07	101
31-18183-K14	95	31-34245-K04	97	31-3A310-972	51	31-6A010-C-T	51	31-98176-K07	101
31-18187-K14	95	31-34247-K04	97	31-3A320-972	52	31-6A010-T	51*	31-98182-K14	101
31-18232-K16	95	31-34931	87	31-3A426	42*	31-6A011	51*	31-98183-K14	101
31-18233-K16	95	31-34940	87	31-3A583	51*	31-6A011-C	51	31-98187-K14	101
31-18235-K16	95	31-34941	87	31-3A910-263	95	31-6A014	51*	31-98232-K16	101
31-18237-K16	95	31-34950	87	31-3A911	95	31-6A020	52*	31-98233-K16	101

Note: * This part number is also displayed on other pages.

Parts Index

Part Number	Pages	Part Number	Pages	Part Number	Pages	Part Number	Pages	Part Number	Pages
31-98235-K16	101	33-14209	125	33-34167	41	33-61042-MTR	172	33-64182-C-K14	45
31-98237-K16	101	33-18042	39	33-34209	125	33-61043-MTR	172	33-64183-C-K14	45
31-98242-K04	101	33-18043	39	33-34531	85	33-61045-MTR	172	33-64187-C-K14	45
31-98243-K04	101	33-18045	39	33-34540	85	33-61047-MTR	172	33-64209	125
31-98245-K04	101	33-18047	39	33-34541	85	33-61072-MTR	172	33-64232-C-K16	45
31-98247-K04	101	33-18058-S82	125	33-34550	85	33-61073-MTR	172	33-64233-C-K16	45
31-9A026	89*	33-18072	39	33-34551	85	33-61075-MTR	172	33-64235-C-K16	45
31-9A053-080-112	48	33-18073	39	33-34560	85	33-61076-MTR	172	33-64237-C-K16	45
31-9A053-080-114	48	33-18075	39	33-34561	85	33-61142-MTR	172	33-64242-C-K04	45
31-9A053-080-2	48*	33-18076	39	33-34570	85	33-61143-MTR	172	33-64243-C-K04	45
31-9A053-080-212	48	33-18142	39	33-37042-12X	162	33-61147-MTR	172	33-64245-C-K04	45
31-9A126	48*	33-18143	39	33-37043-32X	162	33-61162-MTR	172	33-64247-C-K04	45
31-9A583	51*	33-18147	39	33-37046-22X	162	33-61163-MTR	172	33-67042-12X	162
31-9AB26	51*	33-18158-S69	125	33-37047-42X	162	33-61167-MTR	172	33-67043-32X	162
31-9AC26	51*	33-18162	39	33-37072-12X	162	33-61172-C-K07-MTR	172	33-67046-22X	162
31-9AN26	51*	33-18163	39	33-37076-22X	162	33-61173-C-K07-MTR	172	33-67047-42X	162
31-9AR26	51*	33-18165	39	33-37142-12X	162	33-61175-C-K07-MTR	172	33-67072-12X	162
31-CA213	96	33-18167	39	33-37143-32X	162	33-61176-C-K07-MTR	172	33-67076-22X	162
33-11042-MTR	172	33-18209	125	33-37146-22X	162	33-61182-C-K14-MTR	172	33-67142-12X	162
33-11043-MTR	172	33-31042-MTR	172	33-37147-42X	162	33-61183-C-K14-MTR	172	33-67143-32X	162
33-11045-MTR	172	33-31043-MTR	172	33-37162-12X	162	33-61187-C-K14-MTR	172	33-67146-22X	162
33-11047-MTR	172	33-31045-MTR	172	33-37163-32X	162	33-61232-C-K16-MTR	172	33-67147-42X	162
33-11072-MTR	172	33-31047-MTR	172	33-37166-22X	162	33-61233-C-K16-MTR	172	33-67162-12X	162
33-11073-MTR	172	33-31072-MTR	172	33-37167-42X	162	33-61237-C-K16-MTR	172	33-67163-32X	162
33-11075-MTR	172	33-31073-MTR	172	33-38042	41	33-61242-C-K04-MTR	172	33-67166-22X	162
33-11076-MTR	172	33-31075-MTR	172	33-38043	41	33-61243-C-K04-MTR	172	33-67167-42X	162
33-11142-MTR	172	33-31076-MTR	172	33-38045	41	33-61245-C-K04-MTR	172	33-68042	43
33-11143-MTR	172	33-31142-MTR	172	33-38047	41	33-61247-C-K04-MTR	172	33-68043	43
33-11147-MTR	172	33-31143-MTR	172	33-38058-S82	125	33-64042	43	33-68045	43
33-11162-MTR	172	33-31147-MTR	172	33-38072	41	33-64043	43	33-68047	43
33-11163-MTR	172	33-31162-MTR	172	33-38073	41	33-64045	43	33-68058-S82	125
33-11167-MTR	172	33-31163-MTR	172	33-38075	41	33-64047	43	33-68072	43
33-14042	39	33-31167-MTR	172	33-38076	41	33-64058-S82	125	33-68073	43
33-14043	39	33-34042	41	33-38142	41	33-64072	43	33-68075	43
33-14045	39	33-34043	41	33-38143	41	33-64073	43	33-68076	43
33-14047	39	33-34045	41	33-38147	41	33-64075	43	33-68142	43
33-14058-S82	125	33-34047	41	33-38158-S69	125	33-64076	43	33-68143	43
33-14072	39	33-34058-S82	125	33-38162	41	33-64109	125	33-68147	43
33-14073	39	33-34072	41	33-38163	41	33-64142	43	33-68158-S69	125
33-14075	39	33-34073	41	33-38165	41	33-64143	43	33-68162	43
33-14076	39	33-34075	41	33-38167	41	33-64147	43	33-68163	43
33-14109	125	33-34076	41	33-38209	125	33-64158-S69	125	33-68165	43
33-14142	39	33-34109	125	33-38531	85	33-64162	43	33-68167	43
33-14143	39	33-34142	41	33-38540	85	33-64163	43	33-68172-C-K07	45
33-14147	39	33-34143	41	33-38541	85	33-64165	43	33-68173-C-K07	45
33-14158-S69	125	33-34147	41	33-38550	85	33-64167	43	33-68175-C-K07	45
33-14162	39	33-34158-S69	125	33-38551	85	33-64172-C-K07	45	33-68176-C-K07	45
33-14163	39	33-34162	41	33-38560	85	33-64173-C-K07	45	33-68182-C-K14	45
33-14165	39	33-34163	41	33-38561	85	33-64175-C-K07	45	33-68183-C-K14	45
33-14167	39	33-34165	41	33-38570	85	33-64176-C-K07	45	33-68187-C-K14	45

Part Number	Pages	Part Number	Pages	Part Number	Pages	Part Number	Pages	Part Number	Pages
33-68209	125	33-97147-42X	162	36-C0003	208	37-24109	125	37-64072	43
33-68232-C-K16	45	33-97162-12X	162	36-C0003-32M	208	37-24162	49	37-64073	43
33-68233-C-K16	45	33-97163-32X	162	36-C1003	208	37-24163	49	37-64075	43
33-68235-C-K16	45	33-97166-22X	162	36-C1003-32M	208	37-24165	49	37-64076	43
33-68237-C-K16	45	33-97167-42X	162	36-C3003	208	37-24167	49	37-64109	125
33-68242-C-K04	45	33-98042	47	36-C3003-32M	208	37-27042-12X	162	37-64142	43
33-68243-C-K04	45	33-98043	47	36-C6003	208	37-27043-32X	162	37-64143	43
33-68245-C-K04	45	33-98045	47	36-C6003-32M	208	37-27046-22X	162	37-64147	43
33-68247-C-K04	45	33-98047	47	36-C7003	208	37-27047-42X	162	37-64158-S69	125
33-91042-MTR	172	33-98058-S82	125	36-C9003	208	37-27072-12X	162	37-64162	43
33-91043-MTR	172	33-98072	47	36-D0002	208	37-27076-22X	162	37-64163	43
33-91045-MTR	172	33-98073	47	36-D0002-32M	208	37-27162-12X	162	37-64165	43
33-91047-MTR	172	33-98075	47	36-D1002	208	37-27163-32X	162	37-64167	43
33-91072-MTR	172	33-98076	47	36-D1002-32M	208	37-27166-22X	162	37-64172-C-K07	45
33-91073-MTR	172	33-98142	47	36-D3002	208	37-27167-42X	162	37-64173-C-K07	45
33-91075-MTR	172	33-98143	47	36-D3002-32M	208	37-28042	49	37-64175-C-K07	45
33-91076-MTR	172	33-98147	47	36-D6002	208	37-28043	49	37-64176-C-K07	45
33-91142-MTR	172	33-98162	47	36-D6002-32M	208	37-28045	49	37-64182-C-K14	45
33-91143-MTR	172	33-98163	47	36-D7002	208	37-28047	49	37-64183-C-K14	45
33-91147-MTR	172	33-98165	47	36-D9002	208	37-28072	49	37-64187-C-K14	45
33-91162-MTR	172	33-98167	47	36-M7361	208	37-28073	49	37-64209	125
33-91163-MTR	172	33-98209	125	36-M9361	208	37-28075	49	37-64232-C-K16	45
33-91167-MTR	172	36-64042	191	36-N0241-XXX	208	37-28076	49	37-64233-C-K16	45
33-94042	47	36-64043	191	36-N1241-XXX	208	37-28109	125	37-64237-C-K16	45
33-94043	47	36-64045	191	36-N3241-XXX	208	37-28162	49	37-64242-C-K04	45
33-94045	47	36-64047	191	36-N6241-XXX	208	37-28163	49	37-64243-C-K04	45
33-94047	47	36-64072	191	36-N7241	208	37-28165	49	37-64245-C-K04	45
33-94058-S82	125	36-64073	191	36-N9241	208	37-28167	49	37-64247-C-K04	45
33-94072	47	36-64075	191	37-21042-MTR	172	37-28209	125	37-64253-C-K16	45
33-94073	47	36-64076	191	37-21043-MTR	172	37-34531	85	37-67042-12X	162
33-94075	47	36-64142	191	37-21045-MTR	172	37-34540	85	37-67043-32X	162
33-94076	47	36-64143	191	37-21047-MTR	172	37-34541	85	37-67046-22X	162
33-94109	125	36-64147	191	37-21072-MTR	172	37-34550	85	37-67047-42X	162
33-94142	47	36-64162	191	37-21073-MTR	172	37-34551	85	37-67072-12X	162
33-94143	47	36-64163	191	37-21075-MTR	172	37-34560	85	37-67076-22X	162
33-94147	47	36-64167	191	37-21076-MTR	172	37-34561	85	37-67142-12X	162
33-94162	47	36-68042	191	37-21142-MTR	172	37-34570	85	37-67143-32X	162
33-94163	47	36-68043	191	37-21143-MTR	172	37-38531	85	37-67146-22X	162
33-94165	47	36-68045	191	37-21147-MTR	172	37-38540	85	37-67147-42X	162
33-94167	47	36-68047	191	37-21162-MTR	172	37-38541	85	37-67162-12X	162
33-94209	125	36-68072	191	37-21163-MTR	172	37-38550	85	37-67163-32X	162
33-97042-12X	162	36-68073	191	37-21167-MTR	172	37-38551	85	37-67166-22X	162
33-97043-32X	162	36-68075	191	37-24042	49	37-38560	85	37-67167-42X	162
33-97046-22X	162	36-68076	191	37-24043	49	37-38561	85	37-68042	43
33-97047-42X	162	36-68142	191	37-24045	49	37-38570	85	37-68043	43
33-97072-12X	162	36-68143	191	37-24047	49	37-64042	43	37-68045	43
33-97076-22X	162	36-68147	191	37-24072	49	37-64043	43	37-68047	43
33-97142-12X	162	36-68162	191	37-24073	49	37-64045	43	37-68058-S82	125
33-97143-32X	162	36-68163	191	37-24075	49	37-64047	43	37-68072	43
33-97146-22X	162	36-68167	191	37-24076	49	37-64058-S82	125	37-68073	43

Note: * This part number is also displayed on other pages.

Part Number	Pages	Part Number	Pages	Part Number	Pages	Part Number	Pages	Part Number	Pages
3PH1	42*	42-4100T-50P	210	45-3A027	146	45-4800P	141	47-3A021N	133
3PH114	42*	42-4100T-63P	210	45-3A126	146	45-4800P	141	47-3A024	133
3PH12	42*	42-47001	210	45-3A12C	146	45-4800T	141	47-3A029	133
3PH34	42*	42-47002	210	45-3A12D	146	45-4800T	141	47-3A126	130
3PM514	30*	42-47003	210	45-3A15C	146	45-4A027	142	47-3A913-XXX	130
3PM516	30*	42-4700M	210	45-3A15D	146	45-4A12C	142	47-3A925	130*
3PM518	30*	42-4700N	210	45-3A396	146	45-4A12D	142	49-34042	129
3PM520	30*	42-4700P	210	45-3A50C	146	45-4A15C	142	49-34043	129
3PM522	30*	42-4700T	210	45-3A50D	146	45-4A15D	142	49-34045	129
4-0201-A	165	4-2901-A	165	45-3A540	146	45-4A18C	142	49-34046	129
4-0201-B	165	4-2901-B	165	45-3A70C	146	45-4A18C	146	49-34047	129
4-0201-C	165	4-2901-C	165	45-3A70D	146	45-4A18D	142	49-34142	129
4-0201-D	165	4-2901-D	165	45-3A753	146	45-4A18D	146	49-34143	129
4-0301-E	165	4-3301-E	165	45-3A753-A	146	45-4A24C	142	49-34145	129
4-0301-F	165	4-3301-F	165	45-3A753-B	146	45-4A24C	146	49-34146	129
4-0301-G	165	4-3301-G	165	45-3A753-C	146	45-4A24D	142	49-34147	129
4-2301-A	165	4-3401-E	165	45-3A753-D	146	45-4A24D	146	49-38042	129
4-2301-B	165	4-3401-F	165	45-3A753-E	146	45-4A30C	142	49-38043	129
4-2301-C	165	4-3401-G	165	45-3A783	146	45-4A30D	142	49-38045	129
4-2301-D	165	4-3901-E	165	45-3A783-A	146	45-4A40C	142	49-38046	129
4-2401-A	165	4-3901-F	165	45-3A783-B	146	45-4A40D	142	49-38047	129
4-2401-B	165	4-3901-G	165	45-3A783-C	146	45-4A753A	142	49-38142	129
4-2401-C	165	45-34001	145	45-3A783-D	146	47-34042	129	49-38143	129
4-2401-D	165	45-34001-P80	145	45-3A844	146	47-34043	129	49-38145	129
42-41001-32P	210	45-34002	145	45-3A95C	146	47-34045	129	49-38146	129
42-41001-40P	210	45-34002-P80	145	45-3A95D	146	47-34046	129	49-38147	129
42-41001-50P	210	45-34003	145	4,544,001,141		47-34047	129	49-3A011	133
42-41001-63P	210	45-34003-P80	145	45-44001-P80	141	47-34142	129	49-3A013-XXX	130
42-41002-32P	210	45-3400M	145	4,544,002,141		47-34143	129	49-3A014	133
42-41002-40P	210	45-3400M-P80	145	45-44002-P80	141	47-34145	129	49-3A020	133
42-41002-50P	210	45-3400N	145	4,544,003,141		47-34146	129	49-3A021	133
42-41002-63P	210	45-3400N-P80	145	45-44003-P80	141	47-34147	129	49-3A021N	133
42-41003-32P	210	45-3400P	145	454400M	141	47-38042	129	49-3A024	133
42-41003-40P	210	45-3400P-P80	145	45-4400M	141	47-38043	129	49-3A029	133
42-41003-50P	210	45-3400T	145	45-4400N	141	47-38045	129	49-3A126	130
42-41003-63P	210	45-3400T-P80	145	45-4400N-P80	141	47-38046	129	49-3A913-XXX	130
42-4100M-32P	210	45-38001	145	45-4400P	141	47-38047	129	49-3A925	130*
42-4100M-40P	210	45-38001-P80	145	45-4400P	141	47-38142	129	49-44042	129
42-4100M-50P	210	45-38002	145	45-4400T	141	47-38143	129	49-44043	129
42-4100M-63P	210	45-38002-P80	145	45-4400T	141	47-38145	129	49-44045	129
42-4100N-32P	210	45-38003	145	45-48001	141	47-38146	129	49-44046	129
42-4100N-40P	210	45-38003-P80	145	45-48001-P80	141	47-38147	129	49-44047	129
42-4100N-50P	210	45-3800M	145	45-48002	141	47-3A010	133	49-44142	129
42-4100N-63P	210	45-3800M-P80	145	45-48002-P80	141	47-3A011	133	49-44143	129
42-4100P-32P	210	45-3800N	145	45-48003	141	47-3A011N	133	49-44145	129
42-4100P-40P	210	45-3800N-P80	145	45-48003-P80	141	47-3A013-XXX	130	49-44146	129
42-4100P-50P	210	45-3800P	145	45-4800M	141	47-3A014	133	49-44147	129
42-4100P-63P	210	45-3800P-P80	145	45-4800M	141	47-3A019	133	49-48042	129
42-4100T-32P	210	45-3800T	145	45-4800N	141	47-3A020	133	49-48043	129
42-4100T-40P	210	45-3800T-P80	145	45-4800N-P80	141	47-3A021	133	49-48045	129

Note: * This part number is also displayed on other pages.

Parts Index

Part Number	Pages	Part Number	Pages	Part Number	Pages	Part Number	Pages	Part Number	Pages
49-48046	129	49-6A024	133	61-1A024	34	61-6A013-114	30*	63-11075-MTR	171
49-48047	129	49-6A029	133	61-1A027-601	26	61-6A013-12	30*	63-11076-MTR	171
49-48142	129	49-6A126	130	61-1A053-080-1	26	61-6A013-34	30*	63-11162-MTR	171
49-48143	129	49-6A913-XXX	130	61-1A053-080-114	26	61-6A014	33*	63-11163-MTR	171
49-48145	129	49-6A925	130	61-1A053-080-12	26	61-6A020	34	63-11167-MTR	171
49-48146	129	4CN30	74	61-1A053-080-34	26	61-6A020-B	34	63-14042	25
49-48147	129	4MH2	106	61-1A313	26	61-6A020-T	34	63-14043	25
49-4A010	133	4MH2	106	61-1A346	26*	61-6A023-1	30*	63-14045	25
49-4A011	133	4MH212	106	61-1A426	26*	61-6A023-12	30*	63-14047	25
49-4A011N	133	4MH212	106	61-1A583	33*	61-6A023-34	30*	63-14072	25
49-4A013-XXX	130	4MH3	106	61-1A824	34	61-6A024	34	63-14073	25
49-4A014	133	4MH3	106	61-1A826	26	61-6A027	30*	63-14075	25
49-4A019	133	51-BA058	40	61-1AB26	33*	61-6A053-080-1	30*	63-14076	25
49-4A020	133	51-CA058	42	61-1AC26	33*	61-6A053-080-114	30	63-14162	25
49-4A021	133	51-DA058	44	61-1AM26	89*	61-6A053-080-12	30	63-14163	25
49-4A021N	133	59-AA058-1	26	61-1AR26	33*	61-6A053-080-34	30	63-14165	25
49-4A024	133	59-AA058-112	26	61-3A010	33	61-6A346	30*	63-14167	25
49-4A029	133	59-AA058-114	26	61-3A010-B	33	61-6A426	30*	63-18042	25
49-4A126	130	59-AA058-12	26	61-3A010-T	33	61-6A473	30*	63-18043	25
49-4A913-XXX	130	59-AA058-34	26	61-3A013	28*	61-6A824	34	63-18045	25
49-4A925	130	59-BA058-1	28*	61-3A013-1	28*	61-6A826	30*	63-18047	25
49-64042	129	59-BA058-112	28*	61-3A013-114	28*	61-9A010	51*	63-18072	25
49-64043	129	59-BA058-114	28*	61-3A013-12	28*	61-9A010-T	51*	63-18073	25
49-64045	129	59-BA058-12	28*	61-3A013-34	28*	61-9A011	51	63-18075	25
49-64046	129	59-BA058-34	28*	61-3A014	33*	61-9A014	51*	63-18076	25
49-64047	129	59-CA058-1	30*	61-3A020	34	61-9A019	51	63-18162	25
49-64142	129	59-CA058-112	30*	61-3A020-B	34	61-9A020	52	63-18163	25
49-64143	129	59-CA058-114	30*	61-3A020-T	34	61-9A020-T	52*	63-18165	25
49-64145	129	59-CA058-12	30*	61-3A023-12	28*	61-9A021	52*	63-18167	25
49-64146	129	59-CA058-34	30*	61-3A023-34	28*	61-9A024	52*	63-31042-MTR	171
49-64147	129	59-DA058-1	44*	61-3A024	34*	61-9A029	52*	63-31043-MTR	171
49-68042	129	59-DA058-112	44*	61-3A027	28*	61-9A310-262	51*	63-31045-MTR	171
49-68043	129	59-DA058-114	44*	61-3A053-080-1	28*	61-9A320-262	52	63-31047-MTR	171
49-68045	129	59-DA058-12	44*	61-3A053-080-114	28	61-9A551	51*	63-31072-MTR	171
49-68046	129	59-DA058-34	44*	61-3A053-080-12	28	61-9A552	52*	63-31073-MTR	171
49-68047	129	61-1A010	33	61-3A053-080-34	28	61-9A824	52	63-31075-MTR	171
49-68142	129	61-1A010-B	33	61-3A346	28*	61-BA113	95	63-31076-MTR	171
49-68143	129	61-1A010-T	33	61-3A426	28*	61-BA213	96	63-31142-MTR	171
49-68145	129	61-1A011	33	61-3A824	34	61-BA910	95	63-31143-MTR	171
49-68146	129	61-1A013	26	61-3A826	28*	61-BA920	96	63-31147-MTR	171
49-68147	129	61-1A013-1	26	61-3AB26	33*	61-CA113	95	63-31162-MTR	171
49-6A010	133	61-1A013-12	26	61-3AC26	33*	61-CA500	74	63-31163-MTR	171
49-6A011	133	61-1A013-34	26	61-3AM26	89*	61-CA910	95	63-31167-MTR	171
49-6A011N	133	61-1A014	33	61-3AN26	33*	61-CA920	96	63-34042	27
49-6A013-XXX	130	61-1A020	34	61-3AR26	33*	63-11042-MTR	171	63-34043	27
49-6A014	133	61-1A020-B	34	61-6A010	33	63-11043-MTR	171	63-34045	27
49-6A019	133	61-1A020-T	34	61-6A010-B	33	63-11045-MTR	171	63-34047	27
49-6A020	133	61-1A021	34	61-6A010-T	33	63-11047-MTR	171	63-34072	27
49-6A021	133	61-1A023-12	26	61-6A013	30*	63-11072-MTR	171	63-34073	27
49-6A021N	133	61-1A023-34	26	61-6A013-1	30*	63-11073-MTR	171	63-34075	27

Part Number	Pages	Part Number	Pages	Part Number	Pages	Part Number	Pages	Part Number	Pages
63-34076	27	63-64165	29	63-B4002	77	69-94142	31	89-31045-MTR	172
63-34142	27	63-64167	29	63-B8002	77	69-94143	31	89-31047-MTR	172
63-34143	27	63-68042	29	63-C4003	79	69-94147	31	89-31072-MTR	172
63-34147	27	63-68043	29	63-C8003	79	69-94162	31	89-31073-MTR	172
63-34162	27	63-68045	29	66-94042	193	69-94163	31	89-31075-MTR	172
63-34163	27	63-68047	29	66-94043	193	69-94167	31	89-31076-MTR	172
63-34165	27	63-68072	29	66-94045	193	69-98042	31	89-31142-MTR	172
63-34167	27	63-68073	29	66-94047	193	69-98043	31	89-31143-MTR	172
63-38042	27	63-68075	29	66-94072	193	69-98045	31	89-31147-MTR	172
63-38043	27	63-68076	29	66-94073	193	69-98047	31	89-31162-MTR	172
63-38045	27	63-68142	29	66-94075	193	69-98072	31	89-31163-MTR	172
63-38047	27	63-68143	29	66-94076	193	69-98073	31	89-31167-MTR	172
63-38072	27	63-68147	29	66-94142	193	69-98075	31	89-34042	59
63-38073	27	63-68162	29	66-94143	193	69-98076	31	89-34043	59
63-38075	27	63-68163	29	66-94147	193	69-98142	31	89-34045	59
63-38076	27	63-68163	29	66-94162	193	69-98143	31	89-34047	59
63-38142	27	63-68167	29	66-94163	193	69-98147	31	89-34072	59
63-38143	27	63-94042	31	66-94167	193	69-98162	31	89-34073	59
63-38147	27	63-94043	31	66-98042	193	69-98163	31	89-34075	59
63-38162	27	63-94045	31	66-98043	193	69-98167	31	89-34076	59
63-38163	27	63-94047	31	66-98045	193	69-9A010	51	89-34142	59
63-38165	27	63-94072	31	66-98047	193	69-9A010-T	51	89-34143	59
63-38167	27	63-94073	31	66-98072	193	69-9A020	52	89-34147	59
63-61042-MTR	171	63-94075	31	66-98073	193	69-9A020-T	52	89-34162	59
63-61043-MTR	171	63-94076	31	66-98075	193	69-9A029-T	52	89-34163	59
63-61045-MTR	171	63-94142	31	66-98076	193	69-9A110	51	89-34165	59
63-61047-MTR	171	63-94143	31	66-98142	193	69-9A551	51	89-34167	59
63-61072-MTR	171	63-94147	31	66-98143	193	69-9A924	52	89-38042	59
63-61073-MTR	171	63-94162	31	66-98147	193	6H1	44*	89-38043	59
63-61075-MTR	171	63-94163	31	66-98162	193	6H112	44*	89-38045	59
63-61076-MTR	171	63-94165	31	66-98163	193	6H112M	192	89-38047	59
63-61142-MTR	171	63-94167	31	66-98167	193	6H114	44*	89-38072	59
63-61143-MTR	171	63-98042	31	67-9A010	33	6H114M	192	89-38073	59
63-61147-MTR	171	63-98043	31	67-9A010-T	33	6H12	44*	89-38075	59
63-61162-MTR	171	63-98045	31	67-9A014	33	6H12M	192	89-38076	59
63-61163-MTR	171	63-98047	31	67-9A020	33	6H1M	192	89-38142	59
63-61167-MTR	171	63-98072	31	67-9A020-T	34	6H34	44*	89-38143	59
63-64042	29	63-98073	31	67-9A024	34	6H34M	192	89-38147	59
63-64043	29	63-98075	31	67-9A551	33	6PH1	44*	89-38162	59
63-64045	29	63-98076	31	67-9A552	34	6PH112	192	89-38163	59
63-64047	29	63-98142	31	69-1A824	34	6PH112	44*	89-38167	59
63-64072	29	63-98143	31	69-6A924	34	6PH114	44*	89-3A010	65
63-64073	29	63-98147	31	69-94042	31	6PH12	44*	89-3A010-172	65
63-64075	29	63-98162	31	69-94043	31	6PH34	44*	89-3A010-B	65
63-64076	29	63-98163	31	69-94045	31	6PM622	44*	89-3A010-T	65
63-64142	29	63-98165	31	69-94047	31	6PM625	44*	89-3A010-T-172	65
63-64143	29	63-98167	31	69-94072	31	6PM627	44*	89-3A011	65
63-64147	29	63-9A011	33	69-94073	31	6PM629	44*	89-3A014	65
63-64162	29	63-9A019	33	69-94075	31	89-31042-MTR	172	89-3A019	65
63-64163	29	63-9A125	52	69-94076	31	89-31043-MTR	172	89-3A020	66

Note: * This part number is also displayed on other pages.

Parts Index

Part Number	Pages	Part Number	Pages	Part Number	Pages	Part Number	Pages	Part Number	Pages
89-3A020-172	66	89-68045	61	89-91076-MTR	172	89-9A021	66	CG1004P	169
89-3A020-B	66	89-68047	61	89-91142-MTR	172	89-9A021N	66	CG1121A	169
89-3A020-T	66	89-68072	61	89-91143-MTR	172	89-9A024	66	CG1121AM	169
89-3A020-T-172	66	89-68073	61	89-91147-MTR	172	89-9A026	65*	CG1121P	169
89-3A021	66	89-68075	61	89-91162-MTR	172	89-9A027	48*	CG1122A	169
89-3A021N	66	89-68076	61	89-91163-MTR	172	89-9A027M	194	CG1122AM	169
89-3A024	66	89-68142	61	89-91167-MTR	172	89-9A029	66	CG1122P	169
89-3A026	65*	89-68143	61	89-94042	63	89-9A053-080-112	64	CG1123A	169
89-3A027	30*	89-68147	61	89-94043	63	89-9A053-080-114	64	CG1123AM	169
89-3A029	66	89-68162	61	89-94045	63	89-9A053-080-2	64	CG1124A	169
89-3A053-080-1	60	89-68163	61	89-94047	63	89-9A126	64	CG1124AM	169
89-3A053-080-114	60	89-68165	59	89-94072	63	89-9A219-174	65	CG1141A	169
89-3A053-080-12	60	89-68165	61	89-94073	63	89-9A229-174	66	CG1141AM	169
89-3A053-080-34	60	89-68167	61	89-94075	63	89-9A523	65	CG1141P	169
89-3A126	60	89-6A010	65	89-94076	63	89-9A925	66	CG1142A	169
89-3A219-172	65	89-6A010-172	65	89-94142	63	9H1	48*	CG1142AM	169
89-3A229-172	66	89-6A010-B	65	89-94143	63	9H112	48*	CG1142P	169
89-3A523	65	89-6A010-T	65	89-94147	63	9H112M	194	CG1143A	169
89-3A925	66	89-6A010-T-172	65	89-94162	63	9H114	48*	CG1143AM	169
89-61042-MTR	172	89-6A011	65	89-94163	63	9H114M	194	CG1143P	169
89-61043-MTR	172	89-6A014	65	89-94165	63	9H1M	194	CG1144A	169
89-61045-MTR	172	89-6A019	65	89-94167	63	9H2	48*	CG1144AM	169
89-61047-MTR	172	89-6A020	66	89-98042	63	9H2M	194	CG121A	169
89-61072-MTR	172	89-6A020-172	66	89-98043	63	9H34	48*	CG121AM	169
89-61073-MTR	172	89-6A020-B	66	89-98045	63	9H34M	194	CG121P	169
89-61075-MTR	172	89-6A020-T	66	89-98047	63	9-LD12-37	74	CG121PM	169
89-61076-MTR	172	89-6A020-T-172	66	89-98072	63	9MH1	32	CG122A	169
89-61142-MTR	172	89-6A021	66	89-98073	63	9MH112	32	CG122AM	169
89-61143-MTR	172	89-6A021N	66	89-98075	63	9MH114	32	CG122P	169
89-61147-MTR	172	89-6A024	66	89-98076	63	9MH2	32	CG122PM	169
89-61162-MTR	172	89-6A026	65*	89-98142	63	9MH212	32	CG123A	169
89-61163-MTR	172	89-6A027	44*	89-98143	63	9MH2M	194	CG123AM	169
89-61167-MTR	172	89-6A027M	192	89-98147	63	9MH34	32	CG123P	169
89-64042	61	89-6A029	66	89-98162	63	9PH1	48*	CG123PM	169
89-64043	61	89-6A053-080-1	62	89-98163	63	9PH112	48*	CG124A	169
89-64045	61	89-6A053-080-112	62	89-98165	63	9PH114	48*	CG124AM	169
89-64047	61	89-6A053-080-114	62	89-98167	63	9PH2	48*	CG124P	169
89-64072	61	89-6A053-080-2	62	89-9A010	65	9PH34	48*	CG124PM	169
89-64073	61	89-6A126	62	89-9A010-174	65	9PM622	48*	CG125A	169
89-64075	61	89-6A219-172	65	89-9A010-B	65	9PM625	48*	CG125AM	169
89-64076	61	89-6A229-172	66	89-9A010-T	65	9PM627	48*	CG125P	169
89-64142	61	89-6A523	65	89-9A010-T-174	65	9PM629	48*	CG125PM	169
89-64143	61	89-6A925	66	89-9A011	65	CG1001A	169	CG2001A	170
89-64147	61	89-91042-MTR	172	89-9A014	65	CG1001AM	169	CG2001AM	170
89-64162	61	89-91043-MTR	172	89-9A019	65	CG1001P	169	CG2001P	170
89-64163	61	89-91045-MTR	172	89-9A020	66	CG1002A	169	CG2002A	170
89-64165	61	89-91047-MTR	172	89-9A020-174	66	CG1002AM	169	CG2002AM	170
89-64167	61	89-91072-MTR	172	89-9A020-B	66	CG1002P	169	CG2002P	170
89-68042	61	89-91073-MTR	172	89-9A020-T	66	CG1003A	169	CG2003A	170
89-68043	61	89-91075-MTR	172	89-9A020-T-174	66	CG1003P	169	CG2003AM	170

Part Number	Pages	Part Number	Pages	Part Number	Pages	Part Number	Pages	Part Number	Pages
CG2003P	170	FBSS-63-14143	158	MB202	50*	PFLUG10	131	RBT2-C2-167-30A	153
CG2004A	170	FBSS-63-14147	158	MB20212	50*	PFLUG10-90	132	RBT3-C1-077	154
CG2004AM	170	FBW-63-14142	157	MB22212	50*	PFLUG1-90	132	RBT3-C1-167	154
CG2005A	170	FBW-63-14143	157	MB31	26*	PFLUG2	131	RBT3-C2-077-20A	154
CG2005AM	170	FBW-63-14147	157	MB3114	30*	PFLUG20	131	RBT3-C2-077-30A	154
CG2006A	170	FBWSS-63-14142	158	MB312	30*	PFLUG20-90	132	RBT3-C2-167-20A	154
CG2006AM	170	FBWSS-63-14143	158	MB312-NP	122	PFLUG250	131	RBT3-C2-167-30A	154
CG2121A	170	FBWSS-63-14147	158	MB314-NP	122	PFLUG250-90	132	SD18	26*
CG2121AM	170	FDP2	40*	MB31-NP	122	PFLUG2-90	132		
CG2122A	170	FDP3	42*	MB31SS	80	PFLUG3	131		
CG2122AM	170	FDP6	44*	MB334	30*	PFLUG30	131		
CG2123A	170	FH111	40*	MB334-NP	122	PFLUG300	131		
CG2123AM	170	FH311	42*	MB40DR-20	138	PFLUG300-90	132		
CG3001A	170	FH311-473	42*	MB40DR-25	138	PFLUG30-90	132		
CG3001AM	170	FH611	44*	MB40DR-30	138	PFLUG350	131		
CG3002A	170	FH611-473	44*	MB40DR-35	138	PFLUG350-90	132		
CG3002AM	170	H091U1	74*	MB40DR-40	138	PFLUG3-90	132		
CG340A	169	H091U1-185	122	MB40PFQ-XX	130	PFLUG4	131		
CG340AM	169	H091U12	74*	MB40-XX	130	PFLUG40	131		
CG340P	169	H091U12-185	122	MB61	44*	PFLUG400	131		
CG340PM	169	H091U34	74*	MB6112	44*	PFLUG400-90	132		
CG341A	169	H091U34-185	122	MB6112M	192	PFLUG40-90	132		
CG341AM	169	LP-843	26*	MB6114	44*	PFLUG4-90	132		
CG341P	169	MA1	26	MB6114M	192	PFLUG500	131		
CG341PM	169	MA10	48*	MB61M	192	PFLUG500-90	132		
CG342A	169	MA10M	194	MB62	44*	PFLUG600	131		
CG342AM	169	MA110	48*	MB62M	192	PFLUG600-90	132		
CG342P	169	MA2	28*	MC212	40*	PFLUG650	131		
CG342PM	169	MA20	50*	MC234	40*	RBT1-C1-043-20A	152		
CG344A	169	MA220	50*	MC31	98	RBT1-C1-043-30A	152		
CG344AM	169	MA3	30*	MC312	42	RBT1-C1-043-60A	152		
CG344P	169	MA3SS	82	MC61	44*	RBT1-C1-077-20A	152		
CG344PM	169	MA6	44*	MC6114	44*	RBT1-C1-077-30A	152		
CG345A	169	MA660	44*	MC612	44*	RBT1-C1-077-60A	152		
CG345AM	169	MA660M	192	MC634	44*	RBT1-C1-167-20A	152		
CG345P	169	MA6M	192	MP10	48*	RBT1-C1-167-30A	152		
CG345PM	169	MAB6	44*	MP2	40*	RBT1-C1-167-60A	152		
CPF403	133	MAB6M	192	MP3	42*	RBT1-C2-077-20A	152		
CPF405	133	MAFS1	26	MP6	44*	RBT1-C2-077-30A	152		
DN16R	82	MAFS2	28*	MS1	26	RBT1-C2-077-60A	152		
DN63R	84*	MAFS3	30*	MS10	48*	RBT1-C2-167-20A	152		
DS1PC	40*	MB10112	48*	MS10M	194	RBT1-C2-167-30A	152		
DS2MC	50*	MB10112M	194	MS2	28*	RBT1-C2-167-60A	152		
DS3PC	42*	MB10114	48*	MS20	50	RBT1-C3-077	152		
DS6MC	44*	MB10114M	194	MS3	30*	RBT1-C3-167	152		
DS9MC	48*	MB102	48*	MS6	44*	RBT2-C1-077	153		
FB-63-14142	157	MB10212	48*	MS6M	192	RBT2-C1-167	153		
FB-63-14143	157	MB10212M	194	MSPN	74*	RBT2-C2-077-20A	153		
FB-63-14147	157	MB102M	194	MSPN-185	122	RBT2-C2-077-30A	153		
FBSS-63-14142	158	MB20112	50*	PFLUG1	131	RBT2-C2-167-20A	153		

Note: * This part number is also displayed on other pages.

Literature & Website



MELTRIC Corporation is pleased to be able to offer an extensive line of informational material including industry specific brochures, an electrical safety brochure, motor installation guide, and a number of other flyers that will further explain how MELTRIC products can contribute to the safe and efficient operation of industrial or commercial facilities.

To order any of our literature, please make a copy of the opposite page and mail or fax it to MELTRIC.



All MELTRIC literature is available upon request and can be easily downloaded from our website at meltric.com.

Literature Request



A company of MARECHAL ELECTRIC GROUP

4765 W Oakwood Drive • Franklin, WI 53132
 800.433.7642 • 414.817.6160 • Fax 414.433.2701
 mail@meltric.com • meltric.com

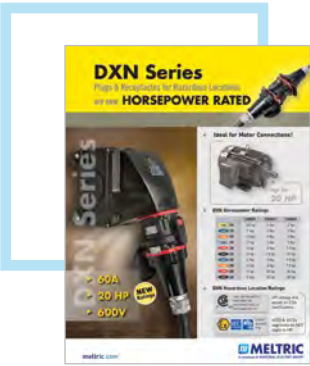

Literature	Quantity
------------	----------

- | | | |
|--|-----------------|------------|
| <input type="checkbox"/> 2017-2018 Main Catalog | CATALOG201718 | _____ |
| <input type="checkbox"/> Current Price List | PRICELIST2016 A | _____ |
| <input type="checkbox"/> DECONTACTOR Brochure | SWITCH-RATED | _____ |
| <input type="checkbox"/> Safety Guide | SAFETYGUIDE | _____ |
| <input type="checkbox"/> Wastewater Industry Brochure | WWSOLNS | _____ |
| <input type="checkbox"/> Food & Beverage Industry Brochure | FOODBEVERAGE | _____ |
| <input type="checkbox"/> Mining and Aggregate Industry Brochure | AGGREGATES | _____ |
| <input type="checkbox"/> Power Generation Industry Brochure | PWRGEN | _____ |
| <input type="checkbox"/> Arc Flash Protection Flyer | ARCFLASH | _____ |
| <input type="checkbox"/> Update Your Plugs & Receptacles Flyer | UPDATE | _____ |
| <input type="checkbox"/> Welding Receptacles Flyer | WELDING | _____ |
| <input type="checkbox"/> Motor Connection Guide Flyer | MTRCONNECTION | _____ |
| <input type="checkbox"/> Busway System Plugs & Receptacles Flyer | BUSWAY | _____ |
| <input type="checkbox"/> 3 Fold Decontactor Mailer | DECMAILER | _____ NFPA |
| <input type="checkbox"/> 3 Fold NFPA 70E Mailer | | _____ |

Name: _____

Company: _____

Address: _____

City: _____ State: _____ Zip: _____

Phone: _____ Fax: _____

E-Mail Address: _____

Complimentary Products

For complimentary Hazardous Location products visit technor.com.

Lighting



Control Stations



Junction Boxes



Flameproof Enclosures



Earthing Systems



Visual Signals



Cable Glands & Fittings



 **Technor**[®]
A company of MARECHAL ELECTRIC GROUP



MARECHAL ELECTRIC GROUP

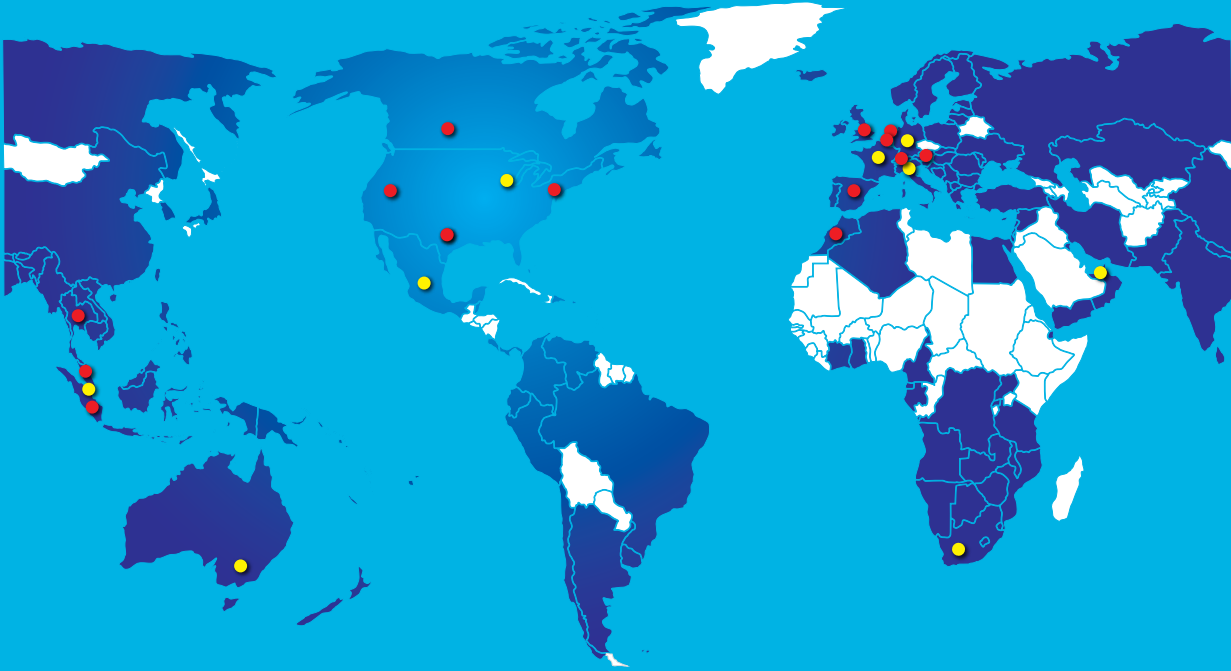

- SALES OFFICES & MANUFACTURING PLANTS
- COMPANY SALES PRESENCE
- SALES AGENTS & DISTRIBUTORS

Thank you for your interest.
For more information, please contact your Meltric Representative...

USA/CANADA/MEXICO

Meltric Corporation
4765 W. Oakwood Park Drive
Franklin, Wisconsin
53132
Tel.: 800.433.7642
Fax: 414.433.2701

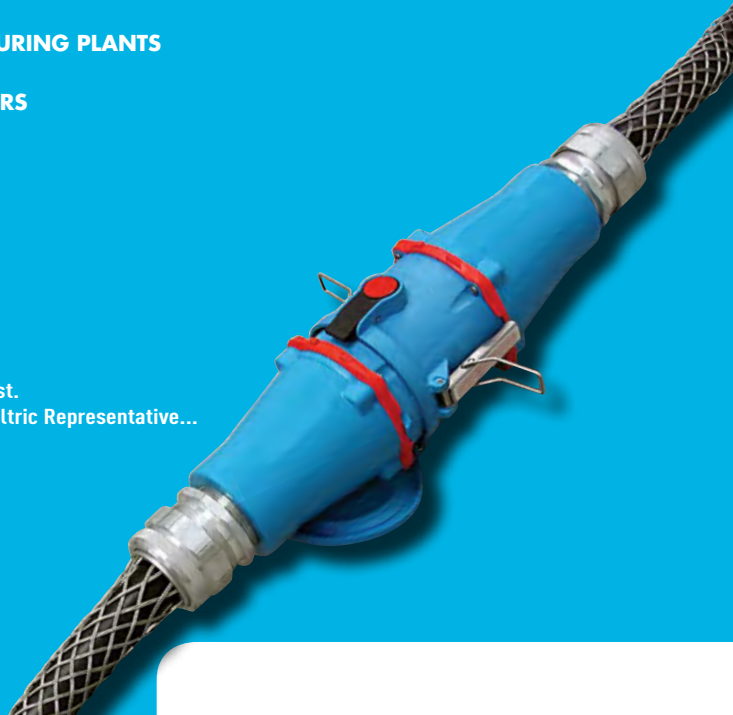

meltric.com

 **MELTRIC**
A company of MARECHAL ELECTRIC GROUP

CATALOG 201718